



# INDICE

<b>CARACTERÍSTICAS Y ESPECIFICACIONES</b>		TT		STS		MALIBU	
BANDAS MICRO-V® STRETCH FIT™	II	<b>BMW</b>	<b>1</b>	XLR		MONTE CARLO	
KITS POWERGRIP® TCK'S COM BOMBA DE AGUA	IV	318I		<b>CHEVROLET</b>	<b>3</b>	MONZA	
KITS PARA BANDAS DE TIEMPO	VI	318IS		ASTRA		OPTRA	
KITS PARA BANDAS MICRO-V®	VI	318TI		ASTRO		P SERIES VAN	
DRIVEALIGN® TENSORES	VI	320I		AVALANCHE		P31 VANETTE	
TENSORES AUTOMÁTICOS Y POLEAS	VIII	323CI		AVEO		PICKUP 1500	
COMPONENTES DE UN TENSOR POWERGRIP	IX	323I		BLAZER		REGAL	
TENSORES HIDRÁULICOS	X	3231I		BLAZER COMPACT		S SERIES PICKUP	
CARACTERÍSTICAS Y ESPECIFICACIONES	XI	3231S		BLAZER FULL SIZE		S-10	
HERRAMIENTAS	XIII	325CI		C Y K SERIES PICKUP		SILVERADO	
<b>FORMAS Y DIMENSIONES</b>		325CI		C Y K SERIES PICKUP C-30		SILVERADO 1500	
Guía de Poleas DriveAlign®	XV	325I		C-20		SILVERADO 2500	
Guía de Poleas Decopladoras DriveAlign®	XVII	325XI		C-2500		SILVERADO 2500 4X4	
Guía de Tensores para DriveAlign® y PowerGrip®	XIX	328CI		C-30		SILVERADO 3500 HD	
Tablas de Aplicaciones de kits para bandas Micro-V®	XXX	328I		C-35		SILVERADO PICKUP	
Tabla de Aplicaciones de kits para PowerGrip®	XXXVII	328IS		C-3500		SILVERADO PICKUP 1500	
<b>APLICACIÓN POR ARMADORA</b>		328XI		CAMARO		SSR	
<b>ACURA</b>	<b>1</b>	330CI		CAMARO Z28		SUBURBAN	
CL		330I		CAPRICE		TAHOE	
INTEGRA		330XI		CAPTIVA		TIGRA	
MDX		525I		CAVALIER		TORNADO	
RL		528I		CAVALIER Z24		TRACKER	
SLX		530I		CELEBRITY		TRAILBLAZER	
TL		540I		CENTURY		TRAILBLAZER EXT	
TSX		545I		CHEVY		UPLANDER	
<b>AUDI</b>	<b>1</b>	740I		CHEVY C2		VECTRA	
A3		740IL		CHEVY C2 SEDAN		VENTURE	
A4		745I		CHEVY JOY		ZAFIRA	
A4 QUATTRO		745LI		CHEVY MILENIO		<b>CHRYSLER</b>	<b>7</b>
A6		750I		CHEVY PICK- UP		300	
A8		750IL		CHEVY POP		300 C	
A8 QUATTRO		750LI		CHEVY SWING		300 M	
ALLROAD QUATTRO		760I		CHEVY		CIRRUS	
CABRIOLET		760LI		CLASSIC		CONCORDE	
Q7		M3		COBALT		CORDOBA	
RS6		M5		COLORADO		CROSSFIRE	
S4		X5		CORSA		DAYTONA	
S4 QUATTRO		Z3		CORVETTE		GRAND VOYAGER	
S6		Z4		CUTLASS		INTREPID	
S8		<b>CADILLAC</b>	<b>2</b>	CUTLASS EUROSPORT		LEBARON	
		CARTERA		EIGHTY EIGHT		LHS	
		CTS		EPICA		NEON	
		DEVILLE		EQUINOX		NEW YORKER	
		DTS		EXPRESS		PACIFICA	
		EL DORADO		EXPRESS CARGO VAN		PT CRUISER	
		ESCALADE		G SERIES VAN		SEBRING	
		REGAL		G20 CHEVY VAN		TOWN & COUNTRY	
		SEVILLE		G30 CHEVY VAN		TOWN & COUNTRY	
		SRX		HHR		VOYAGER	
				IMPALA		VOYAGER TOWN N COUNTR	
				IMPALA SS		<b>DAEWOO</b>	<b>8</b>
				LUMINA		LEGANZA	
				LUMINA APV			

**GATES : LA MARCA DE MÁS PRESTIGIO EN BANDAS, MANGUERAS, HIDRÁULICA Y NEUMÁTICA.**



# INDICE

NUBIRA		ESCAPE		RIDGELINE		E500	
<b>DODGE</b>	<b>8</b>	ESCORT		S2000		E55	
ADVENTURER		EXCURSION		<b>HUMMER</b>	<b>14</b>	G500	
B SERIES VAN		EXPEDITION		H1		G55	
CARAVAN		EXPLORER		H2		ML320	
CHARGER		EXPLORER SPORT TRAC		H3		ML350	
D-150		F SERIES PICKUP		<b>HYUNDAI</b>	<b>14</b>	ML430	
D-250		F-150		ACCENT		ML500	
D-350		F-200		ATOS		ML55	
DAKOTA		F-250		ATTITUD		S430	
DURANGO		F-250 LOBO		H100		S500	
GRAND CARAVAN		F-350 SUPER DUTY		VERNA		S55	
INTREPID		F-450 SUPER DUTY		<b>JAGUAR</b>	<b>14</b>	SL500	
JOURNEY		FIVE HUNDRED		S-TYPE		SL55	
MAGNUM		FOCUS		X-TYPE		SL600	
NEON		FREESTAR		<b>JEEP</b>	<b>14</b>	SLK320	
NITRO		FREESTYLE		CHEROKEE		SLK350	
RAM 1500		FUSION		COMMANDER		SPRINTER	
RAM 2500		GRAND MARQUIS		GRAND CHEROKEE		<b>MERCURY</b>	<b>16</b>
RAM 2500 4 X 4		GT		LIBERTY		COUGAR	
RAM 3500		IKON		WRANGLER		COUGAR LS	
RAM 4000		KA		<b>LAND ROVER</b>	<b>15</b>	COUGAR XR7	
RAM CHARGER		LOBO		DEFENDER 90		GRAND MARQUIS	
RAM MAXI VAN 1500		MONDEO		DISCOVERY		MARINER	
RAM MAXI VAN 2500		RANGER		DISCOVERY SERIES II		MILAN	
RAM MAXI VAN 3500		SERIES F SUPER DUTY		<b>LINCOLN</b>	<b>15</b>	MONTEGO	
RAM MAXI WAGON 3500		SUPER DUTY PICKUP		AVIATOR		MOUNTAINEER	
RAM PICK UP 1500		SUPER DUTY VAN		BLACKWOOD		MYSTIQUE	
RAM PICK UP 2500		TAURUS		CONTINENTAL		SABLE / TAURUS	
RAM SERIES PICKUP		THUNDERBIRD		LS		<b>MITSUBISHI</b>	<b>16</b>
RAM VAN 1500		TOPAZ		MARK VIII		DIAMANTE	
RAM VAN 2500		WINDSTAR		NAVIGATOR		ECLIPSE	
RAM VAN 3500		ZX2		TOWN CAR		ENDEAVOR	
RAM W 2500		<b>GMC</b>	<b>13</b>	ZEPHYR		GALANT	
RAM WAGON 2500		ACADIA		<b>MAZDA</b>	<b>15</b>	LANCER	
RAM WAGON 3500		C Y K SERIES PICKUP		MAZDA 3		MIRAGE	
RAM WAGON 3500 SLT		CANYON		MAZDA 5		MONTERO	
SHADOW		ENVOY		MAZDA 6		MONTERO SPORT	
SPIRIT		JIMMY		MX-5 MIATA		OUTLANDER	
SPRINTER		SAFARI		TRIBUTE		<b>NISSAN</b>	<b>17</b>
STRATUS		SAVANA		<b>MERCEDES BENZ</b>	<b>15</b>	300ZX	
VIPER		SIERRA		C240		ALTIMA	
<b>FIAT</b>	<b>10</b>	SIERRA SERIES PICKUP		C280		APRIO	
DUCATO		SONOMA		C320		ARMADA	
PALIO		YUKON		C43		FRONTIER	
PALIO ADVENTURE		<b>HONDA</b>	<b>14</b>	CL500		MAXIMA	
<b>FORD</b>	<b>10</b>	ACCORD		CL55		MURANO	
AEROSTAR		CIVIC		CLK320		PATHFINDER	
BRONCO		CIVIC DEL SOL		CLK430		PICK-UP	
CONTOUR		CR-V		CLK430		PLATINA	
COUGAR		ELEMENT		CLK500		QUEST	
CROWN VICTORIA		ODYSSEY		CLK55		SENTRA	
E SERIES VAN		PASSPORT		E320		TITAN	
ECOSPORT		PILOT		E430		TSURU	
		PRELUDE				XTERRA	

**GATES : LA MARCA DE MÁS PRESTIGIO EN BANDAS, MANGUERAS, HIDRÁULICA Y NEUMÁTICA.**



# INDICE

<b>OLDSMOBILE</b>	<b>17</b>	AHLAMBRA		POINTER PICK-UP		CLASSIC	
BRAVADA		ALTEA		POLO		CLASSIC XL	
CUTLASS		CORDOBA		SHARAN		COLUMBIA	
CUTLASS CIERA		IBIZA		SPORTVAN		CONDOR	
CUTLASS SUPREME		LEON		TOUAREG		CORONADO	
EIGHTY EIGHT		TOLEDO		VW VAN		FC70	
LSS		<b>SUBARU</b>	<b>19</b>	<b>VOLVO</b>	<b>21</b>	FC80	
NINETY EIGHT		FORESTER		C70		FL112	
REGENCY		IMPRESZA		S40		FL50	
SILHOUETTE		LEGACY		S60		FL60	
<b>PEUGEOT</b>	<b>17</b>	OUTBACK		S70		FL70	
206		<b>SUZUKI</b>	<b>19</b>	S80		FL80	
<b>PONTIAC</b>	<b>17</b>	AERIO		XC90		FLD	
AZTEK		FORENZA		<b>SERVICIO PESADO</b>		FLD120	
BONNEVILLE		RENO		<b>BLUEBIRD</b>	<b>22</b>	FLL70 – 14 TON	
FIREBIRD		SWIFT		ALL AMERICAN FE		UCBC	
FIREBIRD TRANS AM		SX4		ALL AMERICAN RE		<b>INTERNATIONAL / NAVISTAR</b>	<b>25</b>
G3		VERONA		CONVENTIONAL		3300	
G4		VITARA		MINI BIRD		3800	
G5		XL-7		TC2000		4100	
G6		<b>TOYOTA</b>	<b>19</b>	VISION		4200	
G8		4 RUNNER		<b>CHEVROLET</b>	<b>22</b>	4300	
GRAND AM		AVALON		C4500		4400	
GRAND PRIX		CAMRY		C5500		4600	
MONTANA		CAMRY SOLARA		C6500		4700	
SOLSTICE		CELICA		C7500		4700 FBC	
TORRENT		COROLLA		KODIAK		4700 SCD	
TRANS SPORT		FJ CRUISER		KODIAK C6500		4800	
<b>PORSCHE</b>	<b>18</b>	HIGHLANDER		KODIAK C7500		4900	
911		LAND CRUISER		KODIAK C8500		4900 – 210	
BOXSTER		MATRIX		T6500		5000	
<b>RENAULT</b>	<b>18</b>	MR2 SPYDER		T7500		5500	
CLIO		RAV 4		T8500		5500i	
KANGOO		SEQUOIA		W3500		5600	
KANGOO EXPRESS		SIENNA		W4500		5600i	
LAGUNA		SOLARA		<b>DINA</b>	<b>22</b>	5900i	
MEGANE		TACOMA		102 F		7100	
MEGANE I Y II		TUNDRA		104 – R		7300	
SCENIC		<b>VOLKSWAGEN</b>	<b>20</b>	104 – SF		7400	
SCENIC I Y II		BEETLE		94 F		7500	
SAAB		BORA		<b>FORD</b>	<b>22</b>	7600	
<b>SAAB</b>	<b>18</b>	CABRIO		E450 SUPER DUTY		7700	
9 – 3		CORRADO		E550 SUPER DUTY		8100	
9 – 5		CROSSFOX		F SUPER DUTY		8200	
9 – 7X		DERBY		F550 SUPER DUTY		8500	
<b>SATURN</b>	<b>19</b>	EUROVAN		F600		8600	
AURA		GLI		F650 SUPER DUTY		9000 SERIES	
ION		GOLF		F750 SUPER DUTY		9100	
L-SERIES		GOLF GLX VR6		F800		9100i	
RELAY		GTI		<b>FREIGHTLINER</b>	<b>23</b>	9200	
SKY		JETTA		ARGOSY		9200i	
S – SERIES		LUPO		BUSINESS CLASS M2		9300	
VUE		PANEL		CASCADIA		9400	
<b>SEAT</b>	<b>19</b>	PASSAT		CENTURY CLASS		9400i	
		POINTER					

**GATES : LA MARCA DE MÁS PRESTIGIO EN BANDAS, MANGUERAS, HIDRÁULICA Y NEUMÁTICA.**



# INDICE

9600		T800B AEROCAB		385		9700 FL	
9700		T800SH AEROCAB		386		AUTOCAR	
9800		W900		387		VHD	
9900		<b>MACK</b>	<b>28</b>	388		VN SERIES	
9900i		CHN SERIES		389		VNL	
9900ix		CL SERIES		<b>STERLING</b>	<b>29</b>	VNL 64T 420	
BE		CS SERIES		ACTERRA		VNL 64T 420 6X4 TIPICO	
CE		CTP SERIES		A – LINE		VNL 64T 420 STANDAR	
CXT		CV SERIES		L – LINE		VNL 64T 610	
DURASTAR 4300		CX SERIES		<b>THOMAS BUILT</b>	<b>30</b>	VNM	
FE		CXN SERIES		CONVENTIONAL		VT SERIES	
PAYSTAR 5500i		CXP SERIES		MINOTOUR		WG SERIES	
PAYSTAR 5600i		DM SERIES		SAF – T – LINER C2		<b>APLICACION POR PRODUCTO</b>	
PAYSTAR 5900i		LE SERIES		SAF – T- LINER MVP EF		TCKS & COMPONENTES	<b>33</b>
PROSTAR SERIES		MR SERIES		SAF – T- LINER MVP ER		TENSORES Y POLEAS AUTOMOTRIZ	<b>40</b>
RE		RD SERIES		<b>VOLKSWAGEN</b>	<b>30</b>	TENSORES Y POLEAS SERIVICIO PESADO	<b>99</b>
RXT		<b>PETERBILT</b>	<b>28</b>	15 – 190 WORKER		<b>TABLA DE EQUIVALENCIAS</b>	<b>117</b>
TRANSTAR 8500		320		17 – 210 VOLKSBUS			
TRANSTAR 8600		330		17 – 250 WORKER			
WORKSTAR 7600		335		24 – 250 WORKER			
WORKSTAR 7700		357		8 – 150 VOLKSBUS			
<b>KENWORTH</b>	<b>27</b>	362		8 – 150 WORKER			
T2000		365		<b>VOLVO</b>	<b>30</b>		
T300		367		7550			
T600		377		7550 FL			
T660		378		9700			
T800		379					

**GATES : LA MARCA DE MÁS PRESTIGIO EN BANDAS, MANGUERAS, HIDRÁULICA Y NEUMÁTICA.**



Productos Gates \* Características y especificaciones

## Visita nuestra página en Internet para consultar información actualizada!



En nuestro sitio WEB podrás consultar todas las características y especificaciones de nuestros productos, así mismo, podrás descargar los catálogos vigentes, Revistas "Sin Parar" y Boletines en formato electrónico.

También podrás navegar a los diferentes sitios de Gates a nivel mundial, en donde tendrás la oportunidad de consultar todos los productos Gates que aplican para un auto en específico, a través, de las siguientes direcciones:

Catálogo de aplicaciones de Gates USA:

[http://www.gates.com/part\\_locator/index.cfm?go=part\\_locator&location\\_id=3598](http://www.gates.com/part_locator/index.cfm?go=part_locator&location_id=3598)

Catálogo de aplicaciones de Gates en Europa:

<http://www.gatesautocat.com/?go=Gatesautocat>

# www.gates.com.mx

GATES: LA MARCA DE MÁS PRESTIGIO EN BANDAS, MANGUERAS, HIDRÁULICA Y NEUMÁTICA



## Productos Gates \* Características y especificaciones

NUEVO

### BANDAS MICRO-V® STRETCH FIT™

Cada vez más los fabricantes de automóviles comercializan vehículos que no están equipados con un dispositivo de tensado para la transmisión de los accesorios. Las bandas **Stretch Fit™** son la respuesta ideal para estas aplicaciones especiales. Están pretensadas sobre las poleas, manteniendo la tensión suficiente para una transmisión de potencia eficiente durante un largo período de tiempo, pero también lo suficientemente baja para permitir la instalación fácil y evitar fallas en los demás componentes del motor.

#### Características técnicas:

Bandas de alta tecnología diseñadas para el Equipo Original, usan un refuerzo especial en las cuerdas **TwistLock™** que permite mantener una tensión adecuada durante toda la vida de la banda.



#### Recomendaciones para su Instalación:

Cada aplicación tiene instrucciones de instalación únicas. Las instrucciones se muestran en el interior de la Fajilla de cada banda. Es muy importante que estas instrucciones se sigan al pie de la letra para no causar daños a la banda en el momento de su instalación.

Aquí se muestran gráficamente algunos procesos para la instalación de estas bandas:



**Nota Importante:** Se requiere de la longitud específica para cada aplicación, es decir, no existen intercambios con otras bandas Micro-V estándar.

Es necesario contar con una herramienta especial para la instalación de las bandas **Micro-V® Stretch Fit™**, esta herramienta es comercializada por Gates de México, con la siguiente identificación de producto (**No. Parte: 91030**)



GATES: LA MARCA DE MÁS PRESTIGIO EN BANDAS, MANGUERAS, HIDRÁULICA Y NEUMÁTICA



## Productos Gates \* Características y especificaciones

### Lista de principales aplicaciones con parque vehicular en México:

Código	Banda	Años	Marca	Modelo	Motor
85560009	K040355 SF	2009-10	Cadillac	Escalade	6.2 Lts
		2009-10	Chevrolet	Express / Suburban / Silverado / Tahoe	4.8 Lts. / 5.3 Lts.
		2009-10	GMC	Savana / Yukon / Sierra / Avalanche	5.3 Lts. / 6.0 Lts.
		2009-10	Hummer	H2 / H3	5.3 Lts. / 6.2 Lts.
85560002	K040374 SF	2007-09	Dodge	Nitro	4.0 Lts.
85560000	K040352 SF	2007-09	Ford	Edge	3.5 Lts.
		2010 +	Ford	Fusion	3.5 Lts.
85560001	K040362 SF	2008-10	Dodge	Avenger	2.7 Lts.
		2008-10	Ford	Transit	2.2 Lts TDI
85560006	K030195 SF	2006-09	Ford	Fusion	3.0 Lts.
		2006-08	Ford	Escape	3.0 Lts.
		2006-08	Lincoln	Zephyr	3.0 Lts.
		2006-08	Mercury	Milan / Mariner	3.0 Lts.
74680016	91030	MicroV Strech Fit herramienta de instalación			

**Próximamente bandas Micro-V Stretch Fit™ para SAVEIRO y GOL**

GATES: LA MARCA DE MÁS PRESTIGIO EN BANDAS, MANGUERAS, HIDRÁULICA Y NEUMÁTICA



## Productos Gates \* Características y especificaciones

NUEVO

### KITS PowerGrip® TCK's CON BOMBA DE AGUA



Un mal funcionamiento del sistema de transmisión por banda de distribución puede causar graves problemas. Por eso, cuando la bomba de agua y otros componentes fallan afectan directamente a la banda de distribución, por esta razón **Gates recomienda el reemplazo completo de todos los elementos de la transmisión (Banda Timing, Tensor, Poleas y Bomba de agua)**. La extensa gama de kits PowerGrip® de Gates le permite ofrecer a sus clientes un sistema de transmisión completo con **Calidad de Equipo Original**.

La bomba de agua es un componente vital del sistema de refrigeración del vehículo. Asegura un flujo continuo de líquido refrigerante a través del radiador y del motor. Las bombas de agua modernas se accionan por la banda de distribución.

Cuando la bomba de agua falla, el líquido refrigerante se filtra sobre la banda de distribución. Una contaminación prolongada de líquido refrigerante causará finalmente la ruptura de la banda de distribución.

Código	Descripción	Años	Aplicación	No. Comp.
77820329	TCKWP139	1987-2000	Dodge Caravan 3.0L / Hyundai Sonata 3.0L	3
77820330	TCKWP143	1988-1995	Honda Civic 1.5L	3
77820362	TCKWP157	1988-1991	Toyota Camry 2.5L	4
77820361	TCKWP163	1990-1994	Pontiac Sunbird 2.0L	3
77820360	TCKWP172	1990-1993	Subaru Legacy 2.2L	6
77820331	TCKWP184	1997-2001	Honda CR-V 2.0L	3
77820332	TCKWP184A	1990-1995	Acura Integra 1.8L	3
77820333	TCKWP186	1990-1997	Honda Accord / Prelude / Odyssey 2.2L	5
77820349	TCKWP193	1991-1995	Acura Legend 3.2L	3
77820350	TCKWP193A	1996-1998	Acura TL 3.2L	3
77820363	TCKWP194	1991-1996	Ford Escort 1.9L	3
77820364	TCKWP195	1991-1999	Mitsubishi 3000GT 3.0L	4
77820334	TCKWP199	1990-2001	Toyota Camry Celica Rav 4 MR2 2.0 2.2L	4
77820365	TCKWP200	1992-1993	Toyota Camry 3.0L	4
77820366	TCKWP211	1995-1998	Acura TL 2.5L	3
77820367	TCKWP211A	1992-1994	Acura Vigor 2.5L	3
77820368	TCKWP216	1992-1996	Honda Prelude 2.3L	5
77820369	TCKWP219	1993-1994	Dodge Intrepid 3.5L	3
77820335	TCKWP221	1994-1997	Honda Passport 3.2L   Izuzu Trooper 3.2L	4
77820336	TCKWP224	1996-2000	Honda Civic 1.6L	3
77820337	TCKWP224A	1992-199	Honda Civic 1.6L	3
77820374	TCKWP240	1993-1995	Toyota 4 Runner 3.0L	4

GATES: LA MARCA DE MÁS PRESTIGIO EN BANDAS, MANGUERAS, HIDRÁULICA Y NEUMÁTICA





## Productos Gates \* Características y especificaciones

Código	Descripción	Años	Aplicación	No. Comp.
77820375	TCKWP240B	1994-1995	Toyota Pickup 3.0L	4
77820376	TCKWP240C	1989-1992	Toyota 4 Runner 3.0L	4
77820338	TCKWP244	1998-2002	Honda Accord 2.3L	5
77820339	TCKWP245	1995-1998	Dodge Neon Stratus 2.0L	3
77820340	TCKWP245A	1996-2005	Dodge Neon Stratus 2.0L	3
77820341	TCKWP245B	1996-2005	Dodge Neon Stratus 2.0L	3
77820342	TCKWP246	1995-1999	Chrysler Sebring 2.0L   Mitsubishi Eclipse 2.0L	4
77820377	TCKWP259	2001-2005	Dodge Sebring Stratus 3.0L   Mitsubishi Eclipse 2.0L	4
77820378	TCKWP259A	1995-2000	Chrysler Cirrus Sebring 2.5L	4
77820343	TCKWP263	1995-1997	Honda Accord 2.7L	3
77820344	TCKWP265	2003-2008	Chrysler PT Cruiser 2.4L   Jeep Liberty Wrangler 2.4L	4
77820345	TCKWP265A	2003-2008	Chrysler PT Cruiser 2.4L   Jeep Liberty Wrangler 2.4L	4
77820346	TCKWP265B	1997-2002	Dodge Stratus Caravan 2.4L	4
77820347	TCKWP265C	2003-2006	Dodge Neon 2.4L	4
77820370	TCKWP279	1996-2003	Acura RL 3.5L	5
77820348	TCKWP281	1995-2002	Kia Sportage 2.0L	4
77820351	TCKWP283	2000-2004	Ford Focus 2.0L	3
77820352	TCKWP283A	1997-2002	Ford Escort 2.0L	3
77820379	TCKWP287	2003-2004	Mitsubishi Diamante Montero Sport 3.5L	4
77820353	TCKWP296	1998-2004	Volkswagen Golf Jetta Beetle 2.0L	3
77820354	TCKWP297	1998-2005	Volkswagen Passat 2.8L	5
77820371	TCKWP297A	2000-2004	Audi A6 4.2L	6
77820372	TCKWP297B	2002-2005	Audi Allroad Quattro 2.7L	5
77820355	TCKWP306	1999-2005	Volkswagen Golf Jetta Passat Beetle 1.8L	5
77820356	TCKWP306A	1999-2006	Audi A4 1.8L	5
77820357	TCKWP321	1998-2004	Volkswagen Golf Jetta Beetle 1.9L Diesel	6
77820358	TCKWP329	2003-2007	Honda Accord 3.0L	5
77820359	TCKWP331	1998-2007	Volvo V70 2.4L	4
	TCKWP203	2004-2010	Chevrolet Chevy 1.4L	3
	TCKWP077	2010-1981	Nissan Tsuru 1.6L 8 Valvulas	3
	TCKWP260	2008-1998	Volkswagen Pointer 1.8 L	3

GATES: LA MARCA DE MÁS PRESTIGIO EN BANDAS, MANGUERAS, HIDRÁULICA Y NEUMÁTICA



## Productos Gates \* Características y especificaciones

### Kits para bandas de Tiempo (árbol de levas)

Los kits PowerGrip® de Gates te proporcionan una solución completa para el sistema de sincronización de tu automóvil.

Con los kits para bandas de tiempo Gates, no tendrás que comprar los componentes (Banda, Tensores, poleas y tornillos) por separado, los encontrarás en un sólo kit con la garantía de que siempre estarás haciendo el reemplazo de estas piezas con las mismas características del equipo original.

Cada kit incluye todos los componentes para una aplicación en específico:

- Banda Timing
- Polea Tensora
- Polea loca
- Instrucciones de instalación



### Kits para bandas Micro-V® (Serpentín)

Con el nuevo kit para bandas Micro-V® AT, Gates ofrece al mercado todos los componentes necesarios para garantizar un reemplazo completo de la transmisión para accesorios en un sólo kit. Ya no hace falta pedir piezas separadas: los componentes metálicos y las bandas Micro-V® AT vienen en una sola caja, listos para ser instalados.

¡Ahorro de tiempo y comodidad en un sólo kit!

Los kit para bandas Micro-V® incluyen:

- 1 ó 2 Bandas Micro-V® AT
- 1 ó 2 Tensores DriveAlign® de resorte helicoidal
- Las poleas guías necesarias
- Instrucciones de instalación

Nomenclatura: DBKxxxxyy



GATES: LA MARCA DE MÁS PRESTIGIO EN BANDAS, MANGUERAS, HIDRÁULICA Y NEUMÁTICA



## Productos Gates \* Características y especificaciones

### DriveAlign® - Tensores automáticos para bandas Micro-V®

Los tensores automáticos **DriveAlign®** de Gates exceden las especificaciones de equipo original y están disponibles para las principales marcas de autos a nivel mundial.

Los tensores DriveAlign® de Gates le ofrecen:

- Mejoran la vida útil de las Bandas Micro-V® AT
- Aumentan la vida útil de los accesorios
- Reducen costos de mantenimiento
- **Eliminan el ruido de la transmisión**



#### ● ¿Qué es un tensor de bandas?

En el caso de Gates, no solamente es un tensor de bandas, es un tensor **automático** de bandas. Y es un dispositivo que permite aplicar fuerza constante a la banda, haciéndola trabajar a la tensión ideal.

#### ● ¿Cómo funciona?

El tensor funciona de manera óptima solo si se cumplen los siguientes puntos:

- a) Dimensión correcta de la banda.
- b) Poleas bien alineadas.

GATES: LA MARCA DE MÁS PRESTIGIO EN BANDAS, MANGUERAS, HIDRÁULICA Y NEUMÁTICA



## Productos Gates \* Características y especificaciones

Se recomienda hacer el recambio del tensor al mismo tiempo que las bandas y las poleas, esto con el propósito de mantener en óptimo desempeño todos sus componentes. Gates de México, le ofrece **Kits DriveAlign®** para bandas Micro-V® que incluyen el tensor, la banda MICRO-® AT y poleas.

**1. BASE:** Pieza fija del tensor que se acopla al bloque del motor o a otros accesorios. Los diseños de la base varían algunos componentes.

**2. RESORTE:** Precargado de fábrica, permite darle tensión a la banda .

**3. AMORTIGUADOR:** Permite autolubricar las partes internas del tensor.

**4. BRAZO:** Conecta el resorte con la polea del tensor. Generalmente es una cubierta de aluminio.

**5. SELLO:** Previene la contaminación interna.

**6. POLEA:** Puede ser metálico o termoplástico, acanalado o liso. La superficie de la polea se debe revisar constantemente para eliminar residuos que dañen la banda. El componente más importante de la polea es el balero. Para que una polea funcione correctamente, el balero debe ser lubricado correctamente. La causa más frecuente de la falla de la polea es pérdida de lubricación en los baleros. (No reemplace los baleros en una vieja polea).

**7. CUBREPOLVO:** Proteje al balero contra elementos contaminantes.

**8. TORNILLO:** Conecta a la polea con el brazo del tensor.

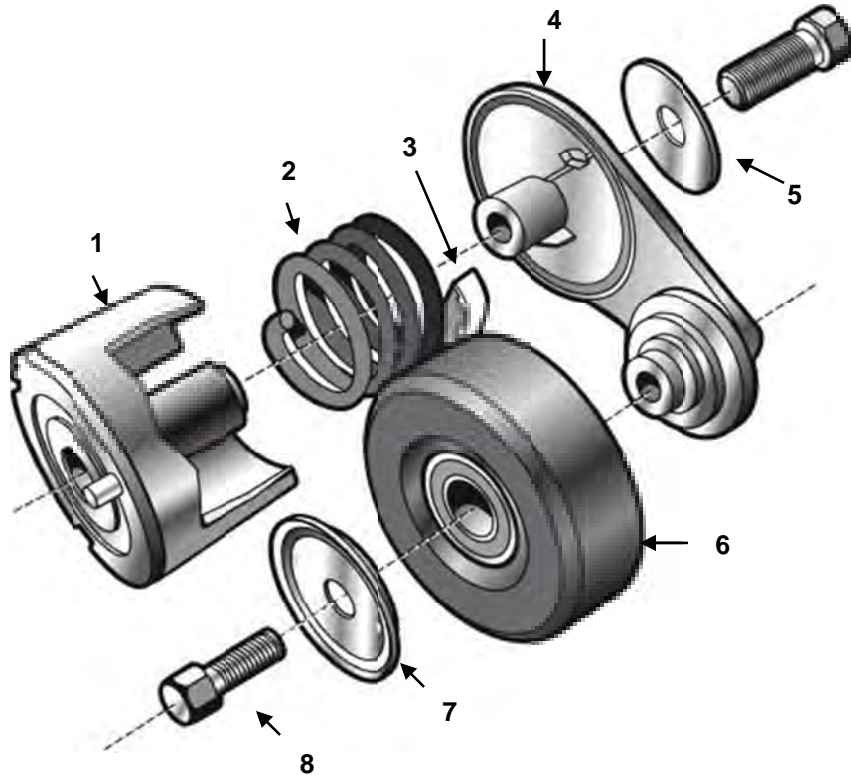

NUEVO

## Tensores automáticos y Poleas para bandas de Tiempo

Los tensores automáticos PowerGrip® de Gates exceden las especificaciones de EQUIPO ORIGINAL y están disponibles para las principales marcas de autos a nivel mundial.

Los tensores PowerGrip® de Gates le ofrecen:

- Mejoran la vida útil de las Bandas Timing
- Reducen costos de mantenimiento
- Eliminan el ruido en la cabina del conductor



GATES: LA MARCA DE MÁS PRESTIGIO EN BANDAS, MANGUERAS, HIDRÁULICA Y NEUMÁTICA

## Productos Gates \* Características y especificaciones

### Componentes de un tensor PowerGrip – para bandas de TIMING

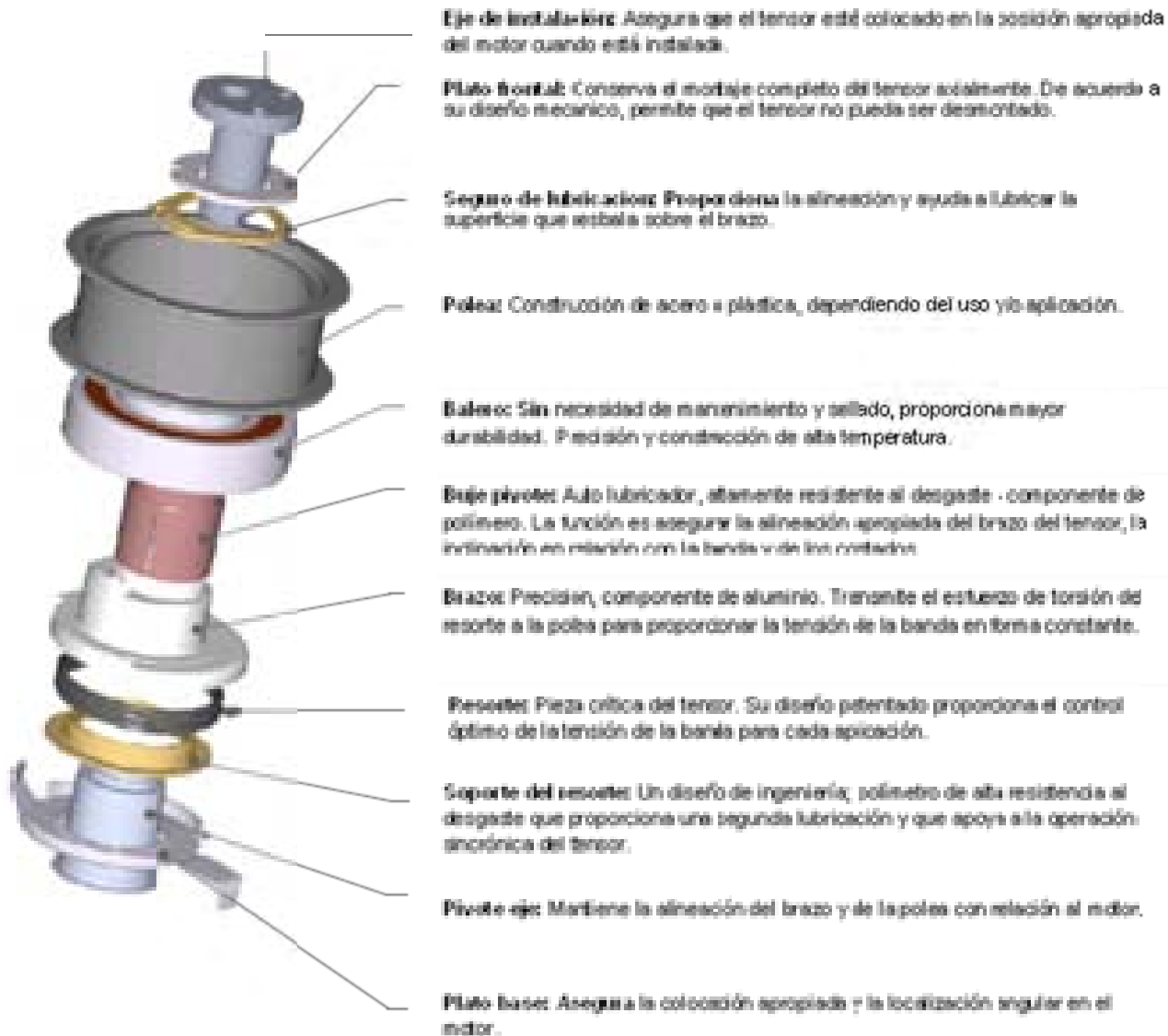

GATES: LA MARCA DE MÁS PRESTIGIO EN BANDAS, MANGUERAS, HIDRÁULICA Y NEUMÁTICA



## Productos Gates \* Características y especificaciones

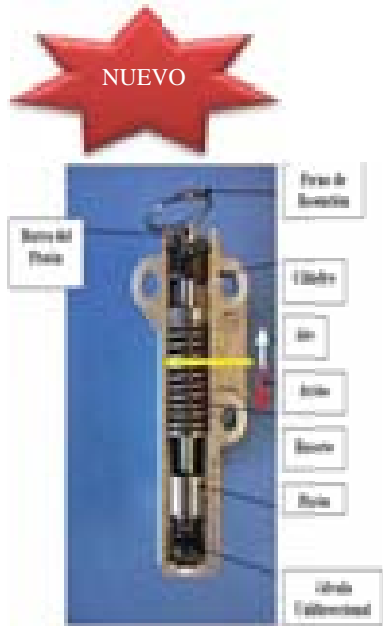

### Tensores hidráulicos



#### ¿Qué es?

El sistema hidráulico es usado principalmente en aplicaciones con vibraciones angulares y/o cargas elevadas, en las cuales un tensor mecánico no puede ofrecer el suficiente desplazamiento. En general el tensor hidráulico necesita más espacio en el motor.

El Tensor Hidráulico consiste en un actuador hidráulico en combinación con una polea. El movimiento de la barra del pistón del actuador es transmitido a la polea del tensor mediante una palanca integrada o separada.

#### ¿Cómo funciona?

El actuador hidráulico trabaja como un amortiguador de choque, donde un resorte en combinación con el aceite, mantiene la rueda en contacto con el asfalto. En este caso, el actuador hidráulico regula la fuerza dinámica de la banda, a la vez que la mantiene en una tensión constante, y compensa los cambios en longitud debidos a expansión térmica.

La barra del pistón se puede mover fácilmente en una dirección debido al aceite que fluye de un lado del pistón hacia el otro, mediante una válvula unidireccional. Las elevadas cargas dinámicas de la banda se regulan mediante el sistema hidráulico, el cual empieza a funcionar a partir del momento en el que el aceite es forzado a fluir entre el pistón y el cilindro.

Este sistema hidráulico se optimiza para cada caso, dependiendo del espacio que se deja entre el pistón, el cilindro y de la viscosidad del aceite.

#### Almacenamiento:

Los actuadores hidráulicos se deben almacenar verticalmente para evitar el escape de aceite y evitar que se mezcle con el aire. La existencia de burbujas de aire en el aceite podría provocar un mal funcionamiento del sistema.

#### Instalación:

El perno de retención sólo debe quitarse después de la instalación de la banda, polea y el actuador.

El motivo de esta recomendación, es que una vez instalado el actuador hidráulico está en una posición vertical, y no hay riesgo de que pueda mezclarse aire en el aceite.

Si el perno se mueve accidentalmente cuando el tensor se encuentra en una posición horizontal, es ALTAMENTE recomendable comprimir la barra del pistón suavemente en posición vertical y posteriormente instalar la pieza. Se deberá dar unas revoluciones manuales al motor con tal de poder separar el aceite y el aire antes de que el motor se encienda.

#### Ventajas:

Debido a que el sistema hidráulico ofrece un recorrido mayor que los tensores mecánicos, es particularmente recomendable para motores V6/V8. Sus características los hacen muy apropiado para controlar el comportamiento dinámico de la banda.

#### ¿Por qué reemplazarlo?

Desgaste normal del cojinete en la polea del tensor.

Escape de aceite por contaminación en las juntas.

GATES: LA MARCA DE MÁS PRESTIGIO EN BANDAS, MANGUERAS, HIDRÁULICA Y NEUMÁTICA



## Productos Gates \* Características y especificaciones

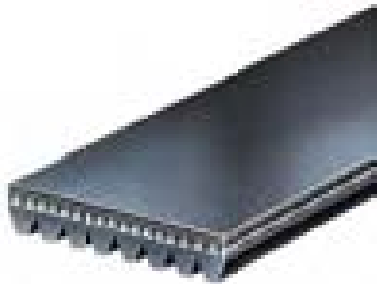

### Bandas Micro-V® AT (Serpentín)

Bandas para serpentín, diseñadas para todas las marcas de automóviles en el mundo. Su diseño especial hace que la banda dure más del doble que su cercano competidor, en aplicaciones problemáticas.

- Silenciosas por su perfil desbastado y alta flexibilidad.
- Mínimo estiramiento por lo que no es necesario re-tensionar.
- Cuerda (refuerzo) de gran resistencia y durabilidad.
- Construido especialmente para resistir desgaste y agrietarse.
- Su diseño especial asegura un control dimensional exacto.
- Exceden las especificaciones de la norma SAE J1459.  
(Tipo de Producto 8552 y 8160).



### Bandas Micro-V® de Doble lado

Para reemplazar las bandas de serpentín de equipo original que requieren un grado más alto de eficacia al transmitir potencia. Diseñadas para las poleas de diámetro pequeños y para el uso con (o sin) los tensores automáticos.

- Pequeñas ranuras en V en ambos lados de la banda.
- Altamente resistente al aceite, al calor y a otras condiciones adversas.
- Amplia cobertura de aplicaciones.
- Exceden los estándares de la Asociación del Fabricante de Hule (RMA por sus siglas en inglés) para la conductividad estática.
- Exceden las especificaciones de la norma SAE J1459.



### TR y XL® bandas en V

La banda más exigente en el Mercado de reemplazo. Su forma trapezoidal con ranuras le permite tener un mejor agarre a las poleas. Esto permite un mejor funcionamiento de la banda, reduciendo su elongación y ruido.

- La acción de su compuesto de hule y su refuerzo, dan mayor flexibilidad a lo largo de toda la banda, ofreciendo una mayor estabilidad en las poleas.
- Cuerdas tensoras con refuerzo de aramida.
- Exceden las especificaciones de la norma SAE J636c.  
(Tipo de producto 8701)



### Bandas Timing para árbol de levas

Diseñadas para altos rangos de velocidad constante y requerimientos de potencia para mover el árbol de levas. Cumple o excede los requerimientos de desempeño de los fabricantes de autos en todo el mundo. Aprobadas para aplicaciones marinas. Gates es el fabricante de estas bandas para las mejores marcas Audi, BMW, Chrysler, Fiat, Ford, GM, Honda, Hyundai, Isuzu, Mazda, Mitsubishi, Nissan, Peugeot, Renault, Subaru, Toyota, Volvo, Volkswagen.

- La más amplia cobertura de aplicaciones en el mercado de reemplazo.
- Resistencia, su cubierta patentada es altamente resistente al calor y al aceite.
- La alta resistencia de sus cuerdas tensoras, minimizan su elongación (estiramiento).  
(Tipo de producto 8595).

GATES: LA MARCA DE MÁS PRESTIGIO EN BANDAS, MANGUERAS, HIDRÁULICA Y NEUMÁTICA



## Productos Gates \* Características y especificaciones

### Bandas para motonetas y cuatrimotos PowerLink®

Bandas de Velocidad variable, cargas de choque. Diseñadas especialmente para Motonetas, Vehículos Todo Terreno - Cuatrimotor (ATV siglas en inglés) y carros de Golf.

- Bandas de alta flexibilidad que permiten mayor agarre a la polea.
- Reforzado con las fibras de aramida para proporcionar un desempeño óptimo.

NOTA: Utilice las bandas especiales PowerLink® para este tipo de aplicación.  
(Tipo de producto 9817 & 9807).



### Bandas Hi-Power® II

Diseñadas para un alto desempeño, secciones disponibles A,B,C,D y E.

Estas han sido las bandas preferidas del mercado por su perfil único y su excelente fabricación.

- Cubierta Flex-Weave® de alta flexibilidad y excelente resistencia al calor, ozono y aceites.
  - Cuerdas Flex-Bonded de alta capacidad de transmisión de potencia y mínimo estiramiento.
  - Paredes curvas y lomo arqueado para una mejor distribución de la fuerza.
  - Su tipo de construcción Multi-propósitos aplica para varios tipos de vehículos.
  - Cumple con las pruebas de conductividad estática de la RMA (Rubber Manufacturer's Association).
  - V80 programa Gates que garantiza el "Hermanaje" de las bandas (de dimensiones iguales).
- (Tipo de producto 9112 Sec. A – 9113 Sec. B).



### Bandas Tri-Power®

Bandas dentadas para la transmisión de potencia en poleas en V, en maquinaria industrial y vehículos de servicio pesado. Combina las ventajas de las tradicionales bandas Hi-Power con las de las bandas dentadas.

(Tipo de producto 9012 Sec. AX – 9013 Sec. BX).



### Bandas Vulco®

Banda forrada recomendada para transmitir potencia y movimiento en poleas en V. Ideal para los motores de Volkswagen enfriados por aire, como el del Sedán por sus características especiales de tensado de la banda.

(Tipo de producto 8560).



### Bandas PowerBand®

Bandas unidas para transmitir potencia en poleas en V para aplicaciones de servicio pesado donde las bandas individuales se voltean por el alto torque en el momento del arranque o durante la aceleración.

(Tipo de producto 8541 Importadas PB, 9091 Nacional PK).

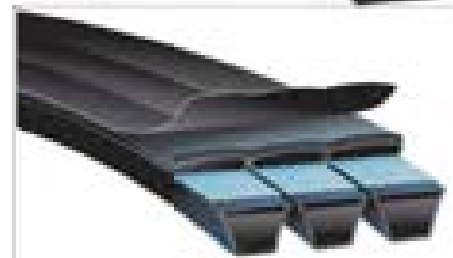

GATES: LA MARCA DE MÁS PRESTIGIO EN BANDAS, MANGUERAS, HIDRÁULICA Y NEUMÁTICA





## Productos Gates \* Características y especificaciones

# Herramientas:



### Alineador Láser DriveAlign™

Exclusivo, herramienta patentada compatible con todas las marcas de automóviles para alineación de poleas.

DriveAlign® (No. De Parte 91006)

Identifica rápidamente los dos tipos de desalineación de las poleas más comunes – desalineación angular y horizontal, los cuales reducen la vida de servicio de los componentes y produce ruido en las transmisiones de las bandas. Simplemente con colocar el alineador en las ranuras de la polea y apuntar el láser a la polea opuesta. Cualquier desalineación será visible en un instante.

- Esta herramienta patentada es compatible con todas las transmisiones que utilicen bandas serpentín.
- Ligera y fácil de usar.
- Incluye lentes especiales que amplifican el láser para mejorar la visión en condiciones de baja iluminación.
- Incluye un estuche durable de alto impacto.



### Medidor Banda Micro-V®

Esta herramienta mide cada banda Micro-V para asistirle en determinar la banda de reemplazo para autos, camionetas, autobuses y camiones de servicio pesado... cuando la banda usada está disponible.

- Se puede medir bandas desde 36" hasta 120". (Cerrado mide solamente 3 pies.)
- Ligero, exacto, y fácil de usar. (No. De Parte 91202)



### Localizador Banda-V

Esta herramienta ayuda a identificar el tipo de banda en V que se requiere.

- Identifica el ancho superior de la banda
- Identifica el tipo y longitud de la banda.
- Ligero, exacto y fácil de usar. (No. De Parte 91201)



### Kit Completo para reemplazo de bandas Timing

(No. Part 91007)

Incluye un probador de tensión para bandas Timing.

(no. part 91000), Una herramienta para fijar los engranes del árbol de levas (no. part 91008) y dos Multi-Lock . (no. part 91009).

GATES: LA MARCA DE MÁS PRESTIGIO EN BANDAS, MANGUERAS, HIDRÁULICA Y NEUMÁTICA



## Productos Gates \* Características y especificaciones

### Krikit II Micro-V® - Medidor de tensión de bandas

(No. Part 91132.)

Diseñado para las bandas Micro-V® en los automóviles, camionetas, Tractocamiones y autobuses.

- Cojín para medir presión y brazo indicador color verde intenso.
- Calibrado para medir la tensión a partir de 100 a 320 libras. y 50 a 150 kilogramos.
- Para hacer mediciones de bandas hasta de 8 costillas de ancho.



### Krikit V-Bandas Medidor de tensión

(Part No. 91107. Charge Item.)

Permite que el usuario tense las bandas durante la instalación, mientras que el motor se encuentre apagado. Esto es importante para un buen funcionamiento de las bandas. Útil para todas las Bandas automotrices en V, se incluyen bandas con anchos superiores a 7/8".

- Incluye instrucciones de uso.
- Lee escalas en libras y kilogramos, a partir de 30 a 160 libras y 15 a 75 kilogramos.
- Cuerpo de aluminio, brazo indicador de nylon y cojín para medir la presión.
- Tiene clip de bolsillo (acero inoxidable).

**NOTA:** No para el uso en bandas TIMING.



### Probador de tensión para bandas Timing

(No. Part 91000)

Proporciona un método exacto para probar la tensión para todas las bandas de sincronización automotriz (Timing).

- El probador de tensión Gates, es útil para cualquier banda Timing hasta 30 mm de ancho.
- Viene con los adaptadores para los diferentes grosores de las bandas.
- Método de aplicación para medir la tensión (desviación de fuerza).
- La escala se puede leer en cualquier posición. Incluye el cupón para el CD-ROM libre de la instalación de la banda dentada.



### Herramienta para tensar las bandas de Serpentin

(No. Part. 91015)

Herramienta ideal para quitar e instalar las bandas de serpiente. Proporciona la fuerza necesaria para desplazar el brazo de la polea tensora.

- El nuevo diseño de 3 barras incluye siete adaptadores (13m m, 14m m, 15m m, 16m m, 18m m, 3/8 " y el 1/2 ").



GATES: LA MARCA DE MÁS PRESTIGIO EN BANDAS, MANGUERAS, HIDRÁULICA Y NEUMÁTICA



Productos Gates \* Características y especificaciones

# Guía de Poleas DriveAlign®

Listado por número de parte

No. De Parte	Material	Diámetro Exterior	Diámetro del buje	Ancho	Tipo de banda	Superficie de la polea
36026	Acero	70mm	12mm	30mm	6 costillas K	V-Ranurada
T36038	Termoplástico	80mm	8mm	30.3mm	6 costillas K	V-Ranurada
36060	Termoplástico	80mm	24mm*	29mm	3/8 V – SAE 10A	V-Ranurada
36086	Acero	84mm	12mm	25mm	6 costillas K	Lisa
36087	Acero	78mm	12mm	20mm	5 Costillas K	Lisa
36091	Acero	74mm	17mm	39.25mm	10 Costillas K	Lisa
36092	Acero	74mm	17mm	46.25mm	12 Costillas K	Lisa
36093	Acero	72.5mm	17mm	38mm	8 Costillas K	V-Ranurada
36094	Termoplástico	78mm	17mm	32.8mm	8 Costillas K	Lisa
36095	Acero	74mm	17mm	32.8mm	8 Costillas K	Lisa
36096	Acero	86.5mm	17mm	39.4mm	10 Costillas K	Lisa
36097	Acero	119mm	17mm	38mm	8 Costillas K	V-Ranurada
36098	Termoplástico	72mm	17mm	39mm	10 Costillas K	V-Ranurada
36099	Acero	70mm	15mm	20.5mm	4 Costillas K	V-Ranurada
36100	Acero	76mm	17mm	29.5mm	6 Costillas K	V-Ranurada
36101	Acero	70mm	17mm	31mm	6 Costillas K	Lisa
36102	Termoplástico	90mm	17mm	32mm	7 Costillas K	V-Ranurada
36103	Acero	107mm	12mm	32mm	3/8 V – SAE 10A	V-Ranurada
38001	Acero	90mm	17mm	30mm	6 Costillas K	Lisa
38002	Acero	100mm	17mm	30.5mm	6 Costillas K	Lisa
38003	Acero	94.5mm	12mm	16.5mm	3/8 V – SAE 10A	V-Ranurada
38004	Acero	118mm	12mm	16.5mm	3/8 V – SAE 10A	V-Ranurada
38005	Acero	82mm	17mm	30.5mm	6 Costillas K	Lisa
38006	Acero	76mm	17mm	30.5mm	6 Costillas K	Lisa
38007	Termoplástico	90mm	17mm	25.5mm	6 Costillas K	Lisa
38008	Termoplástico	70mm	17mm	34.5mm	6 Costillas K	V-Ranurada
38009	Termoplástico	76mm	17mm	25mm	6 Costillas K	V-Ranurada
38010	Acero	90mm	17mm	27mm	5 Costillas K	Lisa
38011	Acero	82mm	17mm	27mm	5 Costillas K	Lisa
38012	Termoplástico	90mm	17mm	32mm	6 Costillas K	Lisa
38015	Termoplástico	76mm	17mm	25mm	6 Costillas K	Lisa
38016	Termoplástico	76mm	17mm	32mm	7 Costillas K	V-Ranurada
38017	Termoplástico	90mm	17mm	22mm	4 Costillas K	V-Ranurada
38018	Termoplástico	70mm	17mm	25mm	6 Costillas K	Lisa
38019	Termoplástico	90mm	17mm	26.3mm	6 Costillas K	V-Ranurada
38020	Acero	90mm	12mm	30.5mm	6 Costillas K	Lisa
38022	Acero	90mm	17mm	37.5mm	8 Costillas K	Lisa
38023	Termoplástico	76mm	17mm	34mm	8 Costillas K	Lisa
38024	Termoplástico	09mm	17mm	26.3mm	6 Costillas K	V-Ranurada
38025	Termoplástico	52mm	17mm	15mm	3 Costillas K	V-Ranurada
38026	Acero	100mm	17mm	28mm	5 Costillas K	Lisa
38027	Termoplástico	82mm	17mm	25mm	6 Costillas K	Lisa
38028	Acero	76mm	17mm	37mm	8 Costillas K	Lisa
38029	Termoplástico	7mm	17mm	26mm	6 Costillas K	V-Ranurada
38030	Acero	70mm	17mm	20.5mm	4 Costillas K	V-Ranurada
38031	Acero	70mm	12mm	20.5mm	4 Costillas K	V-Ranurada
38032	Termoplástico	76mm	17mm	22mm	5 Costillas K	Lisa
38033	Acero	90mm	17mm	33mm	7 Costillas K	Lisa
38034	Termoplástico	27mm	12mm	29mm	6 Costillas K	V-Ranurada
38035**	Acero	94mm	19mm	19mm	1/2 V – SAE 13A	V-Ranurada

GATES: LA MARCA DE MÁS PRESTIGIO EN BANDAS, MANGUERAS, HIDRÁULICA Y NEUMÁTICA



Productos Gates \* Características y especificaciones

# Guía de Poleas DriveAlign®

Listado por número de parte

No. De Parte	Material	Diámetro Exterior	Diámetro del buje	Ancho	Tipo de banda	Superficie de la polea
38036	Acero	81mm	12mm	17.5mm	1/2 V – SAE 13A	V-Ranurada
38037	Acero	81mm	17mm	18mm	1/2 V – SAE 13A	V-Ranurada
38038	Acero	94mm	17mm	19mm	1/2 V – SAE 13A	V-Ranurada
38039**	Acero	94mm		19mm	1/2 V – SAE 13A	V-Ranurada
38040	Acero	123mm	12mm	18.5mm	1/2 V – SAE 13A	V-Ranurada
38041	Acero	76mm	17mm	30.5mm	6 Costillas K	Lisa
38042	Acero	90mm	10mm	30mm	6 Costillas K	Lisa
38043	Acero	76mm	10mm	30mm	6 Costillas K	Lisa
38044	Acero	80mm	17mm	21.8mm	4 Costillas K	V-Ranurada
38045	Termoplástico	70mm	24mm*	28mm	6 Costillas K	Lisa
38046	Termoplástico	80mm	24mm*	27mm	6 Costillas K	Lisa
38047	Termoplástico	70mm	14.5mm*	31.5mm	6 Costillas K	Lisa
38048	Termoplástico	80mm	14.5mm*	31.5mm	6 Costillas K	Lisa
38049**	Acero	80mm		31mm	6 Costillas K	Lisa
38050**	Acero	76mm		31mm	6 Costillas K	Lisa
38051**	Acero	76mm		25mm	6 Costillas K	Lisa
38052	Acero	90mm	17mm	37mm	8 Costillas K	V-Ranurada
38053	Acero	76mm	17mm	38mm	8 Costillas K	V-Ranurada
38058	Termoplástico	76mm	17mm	29.5mm	7 Costillas K	Lisa
38061**	Termoplástico	75mm	24.5mm*	24.5mm	7 Costillas K	Lisa
38062**	Termoplástico	70mm	24mm*	28mm	7 Costillas K	Lisa
38063**	Termoplástico	70mm	17mm	28mm	7 Costillas K	Lisa
38064**	Termoplástico	70mm	24mm*	28mm	7 Costillas K	Lisa
38065**	Termoplástico	70mm	24mm*	28mm	7 Costillas K	Lisa
38066**	Termoplástico	70mm	24mm*	28mm	7 Costillas K	Lisa
38068**	Acero	60mm	25.7mm*	22.5mm	4 Costillas K	V-Ranurada
38069	Termoplástico	80mm	10.2mm	37mm	6 Costillas K	Lisa
38070	Termoplástico	80mm	8mm	21mm	4 Costillas K	Lisa
38071	Termoplástico	70mm	24.5mm*	24.5mm	6 Costillas K	Lisa
38073	Termoplástico	70mm	24mm*	28mm	7 Costillas K	Lisa
38074	Termoplástico	80mm	12.2mm	25mm	6 Costillas K	Lisa
38075	Acero	75mm	30mm	32.5mm	8 Costillas K	Lisa
38076	Acero	75mm	30mm	40mm	10 Costillas K	Lisa
38077	Termoplástico	80mm	17mm	25mm	5 Costillas K	Lisa
38078	Termoplástico	90mm	24.5mm*	27.5mm	6 Costillas K	Lisa
38079	Termoplástico	90mm	24mm*	27.8mm	6 Costillas K	Lisa
38080	Termoplástico	75mm	24mm*	28.5mm	6 Costillas K	V-Ranurada
38081	Termoplástico	80mm	24mm*	31mm	6 Costillas K	Lisa
38082	Termoplástico	63.5mm	17 mm	26.5mm	6 Costillas K	V-Ranurada
38083	Termoplástico	64mm	8.2mm	23mm	6 Costillas K	V-Ranurada
38084	Termoplástico	80mm	14.5mm*	40mm	8 Costillas K	Lisa
38087	Termoplástico	78mm	9mm	25mm	6 Costillas K	Lisa
38088	Acero	70mm	15mm	18mm	3/8 V – SAE 10A	V-Ranurada
38090	Termoplástico	63.5mm	14.5mm*	31mm	6 Costillas K	V-Ranurada
38091	Termoplástico	64mm	14.5mm*	35.5mm	8 Costillas K	V-Ranurada
38092	Termoplástico	70mm	14.5mm*	31mm	6 Costillas K	V-Ranurada
38093	Termoplástico	85mm	14.5mm*	30mm	6 Costillas K	Lisa

\* Doble borde \*\* Esta parte es un montaje del soporte con la polea y por lo tanto faltan algunos datos de medición.

GATES: LA MARCA DE MÁS PRESTIGIO EN BANDAS, MANGUERAS, HIDRÁULICA Y NEUMÁTICA



Productos Gates \* Características y especificaciones

# Guía de Poleas Decopladoras DriveAlign®

Listado por número de parte

No. De Parte	Material	Diámetro Exterior	Diámetro del buje	Ancho	Tipo de banda	Superficie de la polea
37010P	Acero	50mm	14.5mm	40.5mm	6 Costillas K	V-Ranurada
37011P	Acero	55.5mm	14.5mm	37.5mm	6 Costillas K	V-Ranurada
37012P	Acero	55.5mm	14.5mm	42.5mm	6 Costillas K	V-Ranurada
37013P	Acero	52.5mm	14.5mm	35.5mm	6 Costillas K	V-Ranurada
37014P	Acero	56mm	14.5mm	42.5mm	6 Costillas K	V-Ranurada

## Tipo de Poleas DriveAlign®



**Poleas Metálicas y Termoplásticas**

- Dispositivo guía para la banda que actúa con ella al mismo tiempo para transmitir potencia al sistema de accesorios del automóvil.



**Poleas Locas**

- Son aquellas que poseen movimiento libre, es decir, no pertenecen a un componente como bomba de agua, compresor de AA o alternador.



**Poleas Decopladoras**

- Son aquellas que mueven el alternador en conjunto con la banda, sin embargo, la polea tiene un balero especial que le permite rotar libremente en una sola dirección.

- Las poleas Gates se construyen en acero o Nylon, capaces de soportar cargas de choque, altas velocidades (8,000 RPM), carga a la tensión (65,000 lb/pul2), además de ser silenciosas.
- Son las mejores en el mercado de reemplazo, ya que utilizan lubricantes y sellos que soportan mucho mayor grados de temperaturas, previniendo así el desgaste y fallas.

GATES: LA MARCA DE MÁS PRESTIGIO EN BANDAS, MANGUERAS, HIDRÁULICA Y NEUMÁTICA



Productos Gates \* Características y especificaciones

## POLEA DECOPLADORA



Siempre que el motor se desacelera, por ejemplo, durante un cambio de marcha o apagado del motor, la inercia del alternador crea una resistencia en la banda. La polea decopladora permite que el alternador “se mueva libremente” o se “sobre acelere” cuando la banda, de repente aminora la velocidad. Esto evita que la banda se deslice y reduce la vibración, el desgaste y los rechinidos.

**La polea decopladora DriveAlign® de Gates aumenta el rendimiento y la durabilidad de todos los componentes del sistema de transmisión por bandas para accesorios.**

### Componentes de una polea decopladora DriveAlign®



**Gates recomienda: ¡Si una de estas dos pruebas falla, se debe sustituir inmediatamente la polea decopladora!**

**o 1ª prueba:** Utilice el dedo índice y el pulgar para sujetar el anillo interior (eje) en su sitio. Gire el anillo exterior con la otra mano en la misma dirección que lo haría la banda. Si el anillo exterior se mueve, tiene que sustituir la polea decopladora.

**o 2ª prueba:** Sujete el anillo interno (eje) para que no se mueva. Gire el anillo exterior en la dirección contraria a la banda. Probablemente note una pequeña resistencia, pero el anillo exterior debería girar suavemente. Si no lo hace, sustituya la polea decopladora.

GATES: LA MARCA DE MÁS PRESTIGIO EN BANDAS, MANGUERAS, HIDRÁULICA Y NEUMÁTICA



**Productos Gates \* Características y especificaciones**

# Guía de Tensores DriveAlign® y PowerGrip®

Listado por número de parte

No. Parte	Dimensiones
36026	Acero Polea Ranurada 6 costillas (70mm x 12mm x 26mm)
36079	Para Banda de 6 Costillas - Termoplástico (60mm x 20mm x 25mm)
36091	Acero Poleas/Lisa (74mm x 17mm x 39.25mm)
36092	Acero Poleas/Lisa (74mm x 17mm x 46.25mm)
36093	Acero Ranurada 8 Costillas (74mm x 17mm x 37mm)
36095	Acero Poleas/Lisa (74mm x 17mm x 33mm)
36096	Acero Poleas/Lisa (86.5mm x 17mm x 39.4mm)
36098	Termoplástico Ranurada 10 Costillas (74mm x 17mm x 39mm)
36112	Acero Poleas/Lisa (76.3mm x 17mm x 29.5mm)
36115	Acero Poleas/Lisa (83.5mm x 12mm x 18mm)
36116	Acero Polea/Ranurada (100mm x 17mm x 18.8mm)
36118	Acero Polea/Ranurada (80mm x 17mm x 25mm)
36119	Acero Poleas/Lisa (102mm x 17mm x 26mm)
36136	Acero Polea Ranurada 6 costillas (72mm x 15mm x 26mm)
36137	Acero Polea Lisa (70mm x 15mm x 25mm)
36142	Acero Poleas/Lisa (83.5mm x 17mm x 30mm) - W/12mm Bushing
36152	Acero Poleas/Lisa (70mm x 17mm x 20.5mm)
36156	Termoplástico Poleas/Lisa (70mm x 17mm x 19mm)
36157	Acero Polea Ranurada 6 costillas (87mm x 17mm x 31mm) - Flanged
36157	Acero Polea Ranurada 6 costillas (87mm x 17mm x 31mm) - Flanged
36169	Acero Poleas/Lisa (60mm x 12mm x 21.25mm)
38001	Acero Poleas/Lisa (90mm x 17mm x 30.5mm)
38006	Acero Poleas/Lisa (76mm x 17mm x 30.5mm)
38008	Para Banda de 6 Costillas - Termoplástico (70mm x 17mm x 25mm)
38009	Para Banda de 6 Costillas - Termoplástico (76mm x 17mm x 25mm)
38015	Termoplástico Poleas/Lisa (76mm x 17mm x 25mm)
38022	Acero Poleas/Lisa (90mm x 17mm x 37.5mm)
38023	Termoplástico Poleas/Lisa (76mm x 17mm x 34mm)
38028	Acero Poleas/Lisa (76mm x 17mm x 37mm)
38033	Acero Poleas/Lisa (90mm x 17mm x 33mm)
38049	Acero Poleas/Lisa (80mm x N/A x 31mm)
38053	Acero Ranurada 8 Costillas (76mm x 17mm x 38mm)
38061	Termoplástico Poleas/Lisa (75mm x 24.5mm x 8.2mm x 24.5mm) - C/Perno
38062	Termoplástico Poleas/Lisa (70mm x 27mm x 8.2mm x 28mm)

GATES: LA MARCA DE MÁS PRESTIGIO EN BANDAS, MANGUERAS, HIDRÁULICA Y NEUMÁTICA



## Productos Gates \* Características y especificaciones

No. Parte	Dimensiones
38063	Termoplástico Poleas/Lisa (70mm x 17mm x 28mm) - C/Perno
38066	Termoplástico Poleas/Lisa (70mm x 24mm x 8.2mm x 28mm) - C/Perno
38068	Para Banda de 4 Costillas - Acero (60mm x 25.7mm x 10.2mm x 22.5mm)
38075	Acero Poleas/Lisa (75mm x 30mm x 32.5mm)
38076	Acero Poleas/Lisa (75mm x 30mm x 32.5mm)
38092	Para Banda de 6 Costillas - Termoplástico (70mm x 14.5mm x 8mm x 26.5mm)
38099	ND
38101	Para Banda de 6 Costillas - Acero (100mm x 17mm x 30.5mm)
38102	Para Banda de 6 Costillas - Termoplástico (70mm x 17mm x 25mm)
38103	Para Banda de 6 Costillas - Termoplástico (70mm x 17mm x 25mm)
38104	Para Banda de 6 Costillas - Termoplástico (76mm x 17mm x 25mm)
38105	Para Banda de 6 Costillas - Termoplástico (90mm x 17mm x 25.5mm)
38106	Para Banda de 6 Costillas - Termoplástico (76mm x 17mm x 25mm)
38107	Para Banda de 6 Costillas - Acero (90mm x 17mm x 30.5mm)
38108	Para Banda de 6 Costillas - Acero (90mm x 17mm x 30.5mm)
38109	Para Banda de 5 Costillas - Acero (100mm x 17mm x 28mm)
38110	Para Banda de 5 Costillas - Acero (100mm x 17mm x 28mm)
38111	Para Banda de 6 Costillas - Acero (100mm x 17mm x 30.5mm)
38112	Para Banda de 5 Costillas - Acero (90mm x 17mm x 30mm)
38113	Para Banda de 6 Costillas - Acero (90mm x 17mm x 30.5mm)
38114	Para Banda de 6 Costillas - Acero (76mm x 17mm x 30.5mm)
38115	Para Banda de 6 Costillas - Termoplástico (90mm x 17mm x 25.5mm)
38116	Para Banda de 7 Costillas - Termoplástico (76mm x 17mm x 32mm)
38117	Para Banda de 6 Costillas - Acero (76mm x 17mm x 30.5mm)
38118	Para Banda de 6 Costillas - Acero (76mm x 17mm x 30.5mm)
38119	Para Banda de 8 Costillas - Acero (90mm x 17mm x 37.5mm)
38120	Para Banda de 6 Costillas - Acero (82mm x 17mm x 30.5mm)
38121	Para Banda de 6 Costillas - Acero (76mm x 17mm x 30.5mm)
38122	Para Banda de 6 Costillas - Acero (90mm x 17mm x 30.5mm)
38123	Para Banda de 6 Costillas - Acero (76mm x 17mm x 30.5mm)
38124	Para Banda de 6 Costillas - Acero (90mm x 17mm x 30.5mm)
38125	Para Banda de 6 Costillas - Acero (82mm x 17mm x 30.5mm)
38126	Para Banda de 6 Costillas - Acero (82mm x 17mm x 30.5mm)
38127	Para Banda de 6 Costillas - Termoplástico (76mm x 17mm x 25mm)
38128	Para Banda de 6 Costillas - Termoplástico (82mm x 17mm x 25mm)
38129	Para Banda de 6 Costillas - Acero (90mm x 17mm x 30.5mm)
38130	Para Banda de 6 Costillas - Acero (90mm x 17mm x 30.5mm)

GATES: LA MARCA DE MÁS PRESTIGIO EN BANDAS, MANGUERAS, HIDRÁULICA Y NEUMÁTICA





**Productos Gates \* Características y especificaciones**

# Guía de Tensores DriveAlign® y PowerGrip®

Listado por número de parte

No. Parte	Dimensiones
38131	Para Banda de 6 Costillas - Acero (90mm x 17mm x 37.5mm)
38132	Para Banda de 6 Costillas - Acero (76mm x 17mm x 30.5mm)
38133	Para Banda de 8 Costillas - Termoplástico (76mm x 17mm x 34mm)
38134	Para Banda de 6 Costillas - Acero (100mm x 17mm x 30.5mm)
38135	Para Banda de 4 Costillas - Termoplástico (90mm x 17mm x 22mm)
38136	Para Banda de 6 Costillas - Acero Poleas/Lisa (76mm x 17mm x 30.5mm)
38137	Para Banda de 6 Costillas - Termoplástico (70mm x 17mm x 25mm)
38138	Para Banda de 6 Costillas - Termoplástico (90mm x 17mm x 25.5mm)
38139	Para Banda de 6 Costillas - Termoplástico (76mm x 17mm x 25mm)
38140	Para Banda de 6 Costillas - Termoplástico (90mm x 17mm x 32mm) - C/Bridas
38141	Para Banda de 6 Costillas - Termoplástico (90mm x 17mm x 26.3mm)
38142	Para Banda de 6 Costillas - Acero (90mm x 17mm x 30.5mm)
38143	Para Banda de 6 Costillas - Acero (90mm x 17mm x 37.5mm)
38144	Para Banda de 6 Costillas - Termoplástico (90mm x 17mm x 25.5mm)
38145	Para Banda de 6 Costillas - Acero (90mm x 17mm x 30.5mm)
38146	Para Banda de 5 Costillas - Acero (82mm x 17mm x 27mm)
38147	Sin Polea
38148	Para Banda de 6 Costillas - Termoplástico (70mm x 17mm x 25mm)
38150	Para Banda de 6 Costillas - Termoplástico (70mm x 17mm x 25mm)
38151	Para Banda de 5 Costillas - Acero (76mm x 17mm x 24mm)
38152	Para Banda de 6 Costillas - Termoplástico (76mm x 17mm x 25mm)
38153	Para Banda de 6 Costillas - Acero Poleas/Lisa (76mm x 17mm x 30.5mm)
38155	Para Banda de 6 Costillas - Acero Poleas/Lisa (76mm x 17mm x 31mm) – C/Perno
38156	Para Banda de 5 Costillas - Acero (90mm x 17mm x 30mm)
38157	Para Banda de 6 Costillas - Acero Poleas/Lisa (76.2mm x 10.3mm x 33mm)
38158	Para Banda de 6 Costillas - Termoplástico (76mm x 17mm x 25mm)
38159	Para Banda de 4 Costillas - Acero (60mm x 12mm x 21mm)
38160	Para Banda de 6 Costillas - Acero Ranurada (98mm x 17mm x 27mm)
38161	Acero Poleas/Lisa (100mm x 17mm x 30.5mm)
38162	Para Banda de 6 Costillas - Acero (76mm x 17mm x 30.5mm)
38163	Para Banda de 6 Costillas - Termoplástico (70mm x 17mm x 25mm)
38164	Para Banda de 6 Costillas - Termoplástico (76mm x 17mm x 25mm)
38165	Para Banda de 6 Costillas - Termoplástico (76mm x 17mm x 25mm)
38167	Para Banda de 6 Costillas - Acero (90mm x 17mm x 29.5mm); Termoplástico (76mm x 17mm x 28mm)

GATES: LA MARCA DE MÁS PRESTIGIO EN BANDAS, MANGUERAS, HIDRÁULICA Y NEUMÁTICA



## Productos Gates \* Características y especificaciones

No. Parte	Dimensiones
38168	Para Banda de 6 Costillas - Termoplástico (76mm x 17mm x 22mm)
38169	Para Banda de 6 Costillas - Acero (90mm x 17mm x 30.5mm)
38171	Para Banda de 6 Costillas - Acero (90mm x 17mm x 30.5mm)
38172	Para Banda de 6 Costillas - Acero (70mm x 17mm x 24mm)
38173	Acero Poleas/Lisa (102mm x 17mm x 26mm)
38174	Para Banda de 6 Costillas - Termoplástico (90mm x 17mm x 26mm)
38175	Para Banda de 7 Costillas - Termoplástico (62mm x 17mm x 29mm)
38176	Termoplástico Poleas/Lisa (70mm x 17mm x 19mm)
38177	Para Banda de 5 Costillas - Acero (82mm x 17mm x 27mm)
38178	Para Banda de 6 Costillas - Termoplástico (70mm x 17mm x 25mm)
38179	Para Banda de 6 Costillas - Termoplástico (76mm x 17mm x 25mm)
38180	Acero Poleas/Lisa (76mm x 17mm x 31mm)
38181	Acero Poleas/Lisa (76mm x 17mm x 30.5mm)
38182	Acero Poleas/Lisa (76mm x 17mm x 30.5mm)
38185	Acero Poleas/Lisa (70mm x 17mm x 25mm)
38186	Termoplástico Ranurada 6 Costillas (70mm x 17mm x 25mm)
38187	Acero Poleas/Lisa (90mm x 17mm x 30.5mm)
38188	Termoplástico Ranurada 6 Costillas (70mm x 17mm x 25mm)
38189	Acero Poleas/Lisa (76mm x 17mm x 30.5mm)
38190	Termoplástico Poleas/Lisa (70mm x 17mm x 25mm)
38191	Acero Poleas/Lisa (76mm x 17mm x 37mm); Acero Ranurada 8 Costillas (76mm x 17mm x 38mm)
38191	Acero Poleas/Lisa (76mm x 17mm x 37mm); Acero Ranurada 8 Costillas (76mm x 17mm x 38mm)
38192	Acero Poleas/Lisa (70mm x 17mm x 24mm) - C/ Actuador Hidráulico
38193	Para Banda de 6 Costillas - Acero (76mm x 17mm x 25mm)
38194	Para Banda de 6 Costillas - Termoplástico (70mm x 17mm x 25mm)
38195	Termoplástico Ranurada 6 Costillas (70mm x 17mm x 25mm)
38196	Para Banda de 4 Costillas - Termoplástico (65mm x 17mm x 20mm)
38197	Termoplástico Ranurada 3 Costillas (52mm x 17mm x 15mm)
38198	Termoplástico Poleas/Lisa (82mm x 17mm x 25mm)
38200	Para Banda de 6 Costillas - Termoplástico (70mm x 17mm x 25mm)
38201	Termoplástico Poleas/Lisa (70mm x 17mm x 26mm)
38207	Acero Poleas/Lisa (76mm x 17mm x 28mm)
38216	Acero Poleas/Lisa (70mm x 17mm x 32mm) - C/ Actuador Hidráulico
38218	Sin Polea
38219	Sin Polea
38220	Sin Polea
38221	Sin Polea

GATES: LA MARCA DE MÁS PRESTIGIO EN BANDAS, MANGUERAS, HIDRÁULICA Y NEUMÁTICA



## Productos Gates \* Características y especificaciones

No. Parte	Dimensiones
38223	Termoplástico Poleas/Lisa (70mm x 17mm x 26.4mm)
38224	Termoplástico Poleas/Lisa (70mm x 17mm x 26mm)
38225	Sin Polea
38226	Termoplástico Poleas/Lisa (90.2mm x 17mm x 22.8mm)
38245	Termoplástico Ranurada 7 Costillas (90mm x 17mm x 32mm)
38246	Acero Poleas/Lisa (90mm x 17mm x 30.5mm)
38247	Termoplástico Poleas/Lisa (76mm x 17mm x 22mm)
38249	Termoplástico Poleas/Lisa (76mm x 17mm x 26mm)
38250	Acero Poleas/Lisa (76mm x 17mm x 30.5mm)
38251	Acero Poleas/Lisa (76mm x 17mm x 30.5mm)
38256	Acero Poleas/Lisa (90mm x 17mm x 33mm)
38257	Acero Poleas/Lisa (76mm x 17mm x 37mm); Acero Ranurada 8 Costillas (76mm x 17mm x 38mm)
38258	Acero Poleas/Lisa (76mm x 17mm x 30.5mm)
38258	Acero Poleas/Lisa (76mm x 17mm x 30.5mm)
38259	Acero Poleas/Lisa (63mm x 17mm x 18mm)
38260	Termoplástico Ranurada 6 Costillas (76mm x 17mm x 25mm)
38261	Acero Poleas/Lisa (76mm x 17mm x 23mm)
38266	Acero Poleas/Lisa (82mm x 17mm x 31mm)
38268	Termoplástico Poleas/Lisa (76mm x 17mm x 26mm)
38269	Termoplástico Poleas/Lisa (76mm x 17mm x 26mm)
38270	Termoplástico Poleas/Lisa (82mm x 17mm x 30mm)
38271	Acero Poleas/Lisa (76mm x 17mm x 31mm)
38273	Acero Poleas/Lisa (70mm x 17mm x 27mm)
38274	Acero Poleas/Lisa (76mm x 17mm x 30.5mm)
38275	Acero Poleas/Lisa (76mm x 17mm x 30.5mm)
38276	Termoplástico Ranurada 3 Costillas (52mm x 8mm x 13mm)
38277	ND
38278	Acero Poleas/Lisa (76.5mm x 17mm x 37.5mm)
38279	Acero Poleas/Lisa (76mm x 17mm x 30.5mm)
38284	Acero Poleas/Lisa (82.5mm x 17mm x 31mm)
38285	Acero Poleas/Lisa (76mm x 39mm)
38286	Termoplástico Poleas/Lisa (70mm x 17mm x 25mm)
38288	Acero Poleas/Lisa (76mm x 17mm x 30.5mm); Acero Poleas/Lisa (76mm x 17mm x 30.5mm)
38289	Termoplástico Poleas/Lisa (76mm x 17mm x 26mm)
38291	Acero Polea Ranurada 6 costillas (76mm x 17mm x 30mm)
38297	Termoplástico Poleas/Lisa (70mm x 17mm x 34mm)
38298	Acero Poleas/Lisa (76mm x 17mm x 37mm)

GATES: LA MARCA DE MÁS PRESTIGIO EN BANDAS, MANGUERAS, HIDRÁULICA Y NEUMÁTICA



Productos Gates \* Características y especificaciones

# Guía de Tensores DriveAlign® y PowerGrip®

Listado por número de parte

38299	Acero Poleas/Lisa (76.2mm x 17mm x 37mm)
38308	Acero Poleas/Lisa (70mm x 17mm x 25mm)
38317	Termoplástico Ranurada 7 Costillas (70mm x 17mm x 29mm)
38322	Acero Poleas/Lisa (85mm x 17mm x 31mm) – C/ Actuador Hidráulico
38323	Termoplástico Poleas/Lisa (70mm x 17mm x 26mm)
38324	Acero Poleas/Lisa (76mm x 17mm x 31.5mm)
38327	Acero Poleas/Lisa (90mm x 17mm x 29mm)
38328	Para Banda de 6 Costillas - Termoplástico (70mm x 17mm x 30mm)
38329	Acero Ranurada 6 Costillas (76mm x 17mm x 30mm) - C/Bridas
38330	Acero Ranurada 8 Costillas (76mm x 17mm x 38mm)
38332	Acero Poleas/Lisa (76.3mm x 17mm x 29.5mm)
38340	Acero Poleas/Lisa (102.5mm x 17mm x 34.5mm)
38341	Acero Poleas/Lisa (76mm x 17mm x 30.5mm)
38350	Termoplástico Ranurada 7 Costillas (76mm x 17mm x 32mm) - Flanged
38351	Acero Poleas/Lisa (76mm x 17mm x 31mm); Termoplástico Ranurada 6 Costillas (76mm x 17mm x 26mm)
38357	Acero Polea Ranurada 6 costillas (70mm x 17mm x 28mm) - Flanged
38358	Acero Poleas/Lisa (70mm x 17mm x 25mm)
38376	Termoplástico Poleas/Lisa (76mm x 17mm x 26mm)
38378	Acero Poleas/Lisa (76mm x 17mm x 36.3mm)
38382	Termoplástico Ranurada 7 Costillas (80mm x 17mm x 32mm)
38383	Termoplástico Ranurada 6 Costillas (76mm x 17mm x 25mm) - C/Bridas
38384	Termoplástico Poleas/Lisa (70mm x 17mm x 25mm)
38397	Acero Poleas/Lisa (70mm x 17mm x 31mm)
38408	Para Banda de 6 Costillas - Termoplástico (70mm x 17mm x 25mm) - Flanged, W/2 Bolts
38409	Para Banda de 6 Costillas - Termoplástico (70mm x 17mm x 25mm) - Flanged, W/2 Bolts
38411	Acero Poleas/Lisa (70mm x 17mm x 33.3mm)
38417	Termoplástico Poleas/Lisa (70mm x 17mm x 24mm)
38418	Acero Poleas/Lisa (70mm x 17mm x 31mm)
38419	Acero Poleas/Lisa (70mm x 17mm x 31mm)
38420	Para Banda de 6 Costillas - Termoplástico (74mm x 17mm x 26mm) - Flanged
38462	Acero Poleas/Lisa (65mm x 17mm x 23mm)
38501	Para Banda de 8 Costillas - Acero (75mm x 30mm x 32.5mm)
38502	Para Banda de 8 Costillas - Acero (75mm x 30mm x 32.5mm)

GATES: LA MARCA DE MÁS PRESTIGIO EN BANDAS, MANGUERAS, HIDRÁULICA Y NEUMÁTICA



## Productos Gates \* Características y especificaciones

No. Parte	Dimensiones
38503	Para Banda de 10 Costillas - Acero (75mm x 30mm x 40mm)
38504	Para Banda de 10 Costillas - Acero (75mm x 30mm x 40mm)
38505	Para Banda de 6 Costillas - Termoplástico (70mm x 17mm x 25mm)
38506	Para Banda de 10 Costillas - Acero (75mm x 30mm x 40mm)
38507	Acero Poleas/Lisa (75mm x 30mm x 40mm)
38508	Para Banda de 10 Costillas - Acero (75mm x 30mm x 40mm)
38509	Para Banda de 8 Costillas - Acero (75mm x 30mm x 32.5mm)
38510	Acero Poleas/Lisa (75mm x 30mm x 46.5mm)
38511	Para Banda de 10 Costillas - Acero (75mm x 30mm x 40mm)
38512	Para Banda de 10 Costillas - Acero (75mm x 30mm x 40mm)
38513	Para Banda de 10 Costillas - Acero (75mm x 30mm x 40mm)
38514	Para Banda de 10 Costillas - Acero (75mm x 30mm x 40mm)
38516	Acero Ranurada 8 Costillas (76.8mm x 30mm x 33.3mm)
38517	Acero Poleas/Lisa (75mm x 30mm x 32.5mm)
38519	Acero Poleas/Lisa (75mm x 30mm x 46mm)
38521	Acero Poleas/Lisa (75mm x 30mm x 43mm)
38523	Acero Poleas/Lisa (75mm x 30mm x 40mm)
38524	Acero Poleas/Lisa (75mm x 30mm x 40mm)
38525	Acero Ranurada 8 Costillas (76.8mm x 30mm x 33.3mm)
38527	Acero Ranurada 8 Costillas (76.8mm x 30mm x 33.3mm)
38529	Acero Poleas/Lisa (75mm x 30mm x 46.4mm)
38530	Acero Ranurada 12 Costillas (75mm x 30mm x 47.54mm)
38531	Acero Poleas/Lisa (70mm x 30mm x 37.1mm)
38532	Acero Poleas/Lisa (75mm x 30mm x 32.5mm)
38534	Acero Poleas/Lisa (74mm x 30mm x 46.4mm)
38535	Acero Poleas/Lisa (75mm x 30mm x 46.4mm)
38536	Acero Polea Ranurada 10 costillas (74mm x 30mm x 43mm)
38537	Acero Poleas/Lisa (75mm x 30mm x 46.5mm)
38539	Acero Poleas/Lisa (75mm x 30mm x 46.5mm)
38540	Acero Poleas/Lisa (75mm x 30mm x 40mm) - W/Bolt
38541	Acero Poleas/Lisa (75mm x 30mm x 40mm) - W/Bolt
38545	Para Banda de 6 Costillas - Termoplástico (76mm x 17mm x 25mm)
38547	Acero Poleas/Lisa (75mm x 30mm x 37mm) - W/Bolt
38548	Acero Poleas/Lisa (75mm x 30mm x 32.5mm)
38550	Acero Poleas/Lisa (75mm x 30mm x 40mm)
38556	Acero Poleas/Lisa (86.5mm x 30mm x 40mm)
38557	Acero Poleas/Lisa (75mm x 30mm x 40mm)

GATES: LA MARCA DE MÁS PRESTIGIO EN BANDAS, MANGUERAS, HIDRÁULICA Y NEUMÁTICA



## Productos Gates \* Características y especificaciones

No. Parte	Dimensiones
38567	Acero Poleas/Lisa (75mm x 30mm x 32.5mm)
38568	Acero Poleas/Lisa (75mm x 30mm x 32.5mm)
38569	Acero Poleas/Lisa (75mm x 30mm x 32.5mm)
38578	Acero Poleas/Lisa (75mm x 30mm x 40mm)
38579	Acero Poleas/Lisa (86.5mm x 30mm x 40mm)
38581	Acero Polea Ranurada 10 costillas (78mm x 30mm x 38mm) - W/Bolt
38584	Acero Poleas/Lisa (86.5mm x 30mm x 32mm) - W/Bolt
38585	Acero Poleas/Lisa (75mm x 30mm x 40mm)
38586	Acero Poleas/Lisa (75mm x 30mm x 40mm)
38587	Acero Poleas/Lisa (76.3mm x 17mm x 57mm)
38589	Termoplástico Ranurada 6 Costillas (76mm x 17mm x 25mm)
38590	Acero Poleas/Lisa (76mm x 17mm x 46mm)
38597	Acero Poleas/Lisa (75mm x 30mm x 32.5mm)
38598	Acero Poleas/Lisa (75mm x 30mm x 32.5mm)
38599	Termoplástico Ranurada 6 Costillas (76mm x 17mm x 25mm)
38607	Acero Poleas/Lisa (75mm x 30mm x 40mm)
38611	Acero Poleas/Lisa (75mm x 30mm x 46.4mm)
38617	Acero Polea Ranurada 6 costillas (80mm x 30mm x 30mm) - Flanged
38620	Acero Poleas/Lisa (75mm x 30mm x 40mm)
38622	Acero Poleas/Lisa (74mm x 30mm x 43mm)
37008P	Alternator Decoupler Pulleys
37010P	Acero Polea Ranurada 6 costillas (50mm x 14.5mm x 40.5mm)
37012P	Acero Polea Ranurada 6 costillas (55.5mm x 14.5mm x 42.5mm)
37013P	Acero Polea Ranurada 6 costillas (52.5mm x 14.5mm x 35.5mm)
37014P	Acero Polea Ranurada 6 costillas (56mm x 14.5mm x 42.5mm)
T36038	ND
T38415	Acero Poleas/Lisa (70mm x 10mm x 25mm)
T38484	EUR
T41001	Plastica Lisa (72mm x 11mm x 24mm) - Flanged
T41002	Acero Poleas/Lisa (62mm x 10mm x 35mm)
T41005	Steel Cog (47mm x N/A x 30mm)
T41005	Steel Cog (47mm x N/A x 30mm)
T41007	Acero Poleas/Lisa (48mm x 9mm x 32mm) - W/Bolt, Washer, Lock Washer, Nut
T41008	Plastica Lisa (85mm x Slotted x 30mm)
T41011	Acero Poleas/Lisa (57mm x Slotted x 26mm)
T41013	Acero Poleas/Lisa (70mm x Slotted x 19mm)
T41014	Acero Poleas/Lisa (62mm x Slotted x 27mm)

GATES: LA MARCA DE MÁS PRESTIGIO EN BANDAS, MANGUERAS, HIDRÁULICA Y NEUMÁTICA



## Productos Gates \* Características y especificaciones

No. Parte	Dimensiones
T41015	Acero Poleas/Lisa (65mm x Slotted x 32mm)
T41016	Acero Poleas/Lisa (55mm x Slotted x 30mm)
T41020	Acero Poleas/Lisa (55mm x Slotted x 24mm)
T41021	Acero Poleas/Lisa (55mm x Slotted x 32mm)
T41022	Acero Poleas/Lisa (70mm x Slotted x 19mm)
T41023	Acero Poleas/Lisa (53mm x Slotted x 26mm)
T41024	Acero Poleas/Lisa (55mm x N/A x 28mm)
T41028	Acero Poleas/Lisa (60mm x 30mm x 36mm) - W/Bushing, Bolt, 2 Washers, Lock Washer
T41031	Acero Poleas/Lisa (52mm x Slotted x 25mm)
T41037	Acero Poleas/Lisa (60mm x N/A x 28.5mm) - C/Bridas
T41038	Acero Poleas/Lisa (55mm x 8.5mm x 18.5mm) - Flanged
T41039	Acero Poleas/Lisa (60mm x 10mm x 35mm)
T41044	Acero Poleas/Lisa (60mm x N/A x 29mm) - Flanged
T41048	Acero Poleas/Lisa (60mm x Slotted x 32mm)
T41054	Acero Poleas/Lisa (60mm x 10mm x 33mm) - Flanged
T41058	Acero Poleas/Lisa (60mm x 8.5mm x 26mm) - C/Bridas
T41059	Acero Poleas/Lisa (60mm x 10mm x 30mm)
T41064	Plastica Lisa (58mm x 8.2mm x 25mm)
T41065	Acero Poleas/Lisa (51mm x 8mm x 28mm)
T41067	Acero Poleas/Lisa (57.5mm x ranurado x 29mm)
T41070	Acero Poleas/Lisa (57.5mm x ranurado x 29mm)
T41075	Acero Poleas/Lisa (62mm x 8.1mm x 36.5mm)
T41078	Acero Poleas/Lisa (62mm x 8.1mm x 36.5mm)
T41079	Acero Poleas/Lisa (72mm x 10.3mm x 25.4mm) - C/Bridas
T41084	Acero Poleas/Lisa (62mm x 10mm x 35mm) - C/Perno
T41085	Acero Poleas/Lisa (60mm x 10mm x 36mm)
T41090	Acero Poleas/Lisa (55mm x 10.1mm x 30mm)
T41098	Acero Poleas/Lisa (62mm x 10mm x 34mm) - W/Bushing, Bolt, Washer
T41107	Acero Poleas/Lisa (71mm x 10.3mm x 30mm) - C/Bridas
T41204	Acero Poleas/Lisa (62mm x 12mm x 40mm) - C/Actuador hidráulico
T41212	Acero Poleas/Lisa (57.5mm x 34mm)
T41228	Acero Poleas/Lisa (58mm x 10.1mm x 36mm) - Flanged
T41229	Acero Poleas/Lisa (40mm x 8mm x 36mm)
T41230	Acero Poleas/Lisa (28mm x 8mm x 34mm)
T41232	Acero Poleas/Lisa (55mm x 19mm x 24mm)
T41237	EUR
T41241	EUR

GATES: LA MARCA DE MÁS PRESTIGIO EN BANDAS, MANGUERAS, HIDRÁULICA Y NEUMÁTICA



**Productos Gates \* Características y especificaciones**

# Guía de Tensores DriveAlign® y PowerGrip®

Listado por número de parte

No. Parte	Dimensiones
T42002	Acero Poleas/Lisa (70mm x 10.4mm x 38mm)
T42005	Acero Poleas/Lisa (52mm x 10.5mm x 25mm)
T42016	Acero Poleas/Lisa (55mm x 10.3mm x 25mm)
T42017	Acero Poleas/Lisa (60mm x 10.5mm x 32mm)
T42018	Acero Poleas/Lisa (57.5mm x 10.3mm x 38mm) - Flanged
T42019	Acero Poleas/Lisa (28mm x 10mm x 27mm) - W/Bolt
T42020	Acero Poleas/Lisa (60mm x 10.5mm x 36mm)
T42021	Acero Poleas/Lisa (50mm x 10.5mm x 36mm)
T42023	Acero Poleas/Lisa (60mm x 10.5mm x 35mm)
T42024	Steel Cog (60mm x 10.5mm x 35mm)
T42024	Steel Cog (60mm x 10.5mm x 35mm)
T42025	Acero Poleas/Lisa (57.5mm x 12mm x 29mm)
T42030	Acero Poleas/Lisa (62mm x 12mm x 36.5mm)
T42031	Acero Poleas/Lisa (66mm x 12mm x 37.5mm)
T42032	Plastica Lisa (48mm x 10.4mm x 29mm)
T42033	Plastica Lisa (60mm x 10.4mm x 28.5mm)
T42034	Termoplástico Poleas/Lisa (47mm x 17mm x 29mm)
T42035	Termoplástico Poleas/Lisa (70mm x 10.4mm x 29mm)
T42036	Termoplástico Poleas/Lisa (60mm x 10.4mm x 29mm) - C/Separador
T42038	Acero Poleas/Lisa (55mm x 19.2mm x 30mm)
T42061	EUR
T42115	Acero Poleas/Lisa (60mm x 10mm x 36mm)
T42121	Acero Poleas/Lisa (58mm x N/A x 35.2mm) - C/Perno
T42166	EUR
T43001	Acero Poleas/Lisa (67mm x 9mm x 33mm)
T43003	Termoplástico Poleas/Lisa (60mm x 8mm x 30mm)
T43004	Acero Poleas/Lisa (65mm x 8.5mm x 32mm)
T43005	Acero Poleas/Lisa (70mm x 8.5mm x 32mm)
T43006	Plastica Lisa (67mm x 8mm x 30mm) - Flanged
T43007	Acero Poleas/Lisa (67mm x 8mm x 30mm) - C/Bridas
T43008	Acero Poleas/Lisa (67mm x 8mm x 33mm)
T43010	Acero Poleas/Lisa (72mm x 8mm x 30mm) - C/Bridas
T43016	Acero Poleas/Lisa (72mm x 18mm x 30mm) - Flanged, C/Perno, Bushing, Bolt, Washer
T43017	Acero Poleas/Lisa (72mm x 10mm x 30mm) - Flanged, W/Bushing, Bolt

GATES: LA MARCA DE MÁS PRESTIGIO EN BANDAS, MANGUERAS, HIDRÁULICA Y NEUMÁTICA





## Productos Gates \* Características y especificaciones

No. Parte	Dimensiones
T43023	Acero Poleas/Lisa (70mm x 8mm x 30mm)
T43027	Actuador
T43029	Actuador
T43032	Sin Polea
T43039	Plastica Lisa (60.6mm x NA x 29.6mm) - C/Perno, Spring
T43064	Acero Poleas/Lisa (65.4mm x 8.1mm x 32mm)
T43066	Actuador
T43068	EUR
T43073	Actuador
T43091	Acero Poleas/Lisa (68mm x 8.2mm x 36mm) - C/Bridas, C/Resorte
T43095	Sin Polea
T43096	Sin Polea
T43097	Sin Polea
T43098	Sin Polea
T43131	Acero Poleas/Lisa (67mm x 9mm x 33mm)
T43132	Acero Poleas/Lisa (67mm x 8mm x 33mm) - C/Base
T43142	EUR
T43163	EUR
T43166	EUR
TMV-13001	Acero Poleas/Lisa (70mm x 15mm x 26mm)
TMV-14001	Acero Poleas/Lisa (76.2mm x 15mm x 35mm)
TMV-22001	Acero Poleas/Lisa (76.2mm x 15mm x 35mm) (Dos poleas lisas)
TMV-22002	Acero Polea/Ranurada ( 77.2mm x 15mm x 35mm) (Polea lisa y Polea Ranurada)
TMV-23001	Acero Polea/Lisa (70mm x 10.9mm x 22mm)
TPG-14001	Acero Polea/Lisa (59mm x 8mm x 22mm)
TPG-14002	Acero Polea/Lisa (59mm x 8mm x 26mm)
TPG-14003	Acero Polea/Lisa (59mm x 8mm x 19mm)
TPG-14004	Acero Polea/Lisa (59mm x 13.8mm x 22mm)
TPG-20001	Acero Polea/Lisa (59mm x 13mm x 22mm)
TPG-22001	Acero Polea/Lisa (73mm x 8mm x 27mm)
TPG-23001	Acero Polea/Lisa (62mm x 8mm x 22mm)

GATES: LA MARCA DE MÁS PRESTIGIO EN BANDAS, MANGUERAS, HIDRÁULICA Y NEUMÁTICA



## Productos Gates \* Características y especificaciones



### Tabla de Aplicaciones de kits para bandas Micro-V® (Serpentín)



Kit	Marca	Vehiculo	Motor	Años	Observaciones	Componentes
DBK050400	CHEVROLET	CAVALIER	4 CIL. 2.2 LTS.	2002-2005		2
DBK050400	CHEVROLET	HHR	4 CIL. 2.2 LTS.	2006-2007		2
DBK050400	CHEVROLET	HHR	4 CIL. 2.4 LTS.	2006-2007		2
DBK050478	CHEVROLET	ASTRA	4 CIL. 1.8 LTS.	2003-2000	C/AA Y D/H	2
DBK050570	CHEVROLET	ASTRA	4 CIL. 1.8 LTS.	2003-2000	S/AA	2
DBK050887	CHEVROLET	CAVALIER	4 CIL. 2.2 LTS.	1998-2002		3
DBK060570A	CHEVROLET	CHEVY (TODOS)	4 CIL. 1.6 L	2009-1995	SERPENTIN , S/AA	2
DBK060705	CHEVROLET	CHEVY (JOY-SWING-POP)	4 CIL. 1.6 L	2003-1995	SERPENTIN , C/AA	2
DBK060708	CHEVROLET	CHEVY C2	4 CIL. 1.6 L	2009-2004	SERPENTIN , C/AA	2
DBK060744	CHEVROLET	OPTRA	4 CIL. 2.0 LTS.	2006-2007		2
DBK060864A	CHEVROLET	MALIBU	V6 3.1 LTS.	2000-2003		3
DBK060864B	CHEVROLET	VENTURE	V6 3.4 LTS.	2000-2005		-2 3
DBK060882	CHEVROLET	MALIBU	V6 3.5 LTS.	2004-2006		3
DBK060950	CHEVROLET	BLAZER	V6 4.3 LTS.	2000-2005		3
DBK040551	CHRYSLER	PT CRUISER	4 CIL. 2.4 LTS.	2003-2007		2
DBK060806	DODGE	CARAVAN/VOYAGER	V6 3.0 LTS.	1996-2000		2
DBK060815B	DODGE	CARAVAN/VOYAGER	V6 3.0 LTS.	1991-1995		2
DBK060825	DODGE	CARAVAN/VOYAGER	V6 3.3 LTS.	2001-2007		3
DBK060825	DODGE	CARAVAN/VOYAGER	V6 3.8 LTS.	2001-2007		3
DBK060876	DODGE	RAM PICK-UP	V6 3.7 LTS.	2002-2007	1500 / 2500	2
DBK060876A	DODGE	RAM PICK-UP	V8 4.7 LTS.	2004-2007	1500 / 2500	3
DBK060882D	DODGE	RAM PICK-UP	V8 4.7 LTS.	2002-2003	1500 / 2500	3
DBK060966	DODGE	CARAVAN/VOYAGER	V6 3.3 LTS.	1996-2000	C/AA	2
DBK060966	DODGE	CARAVAN/VOYAGER	V6 3.8 LTS.	1996-2000	C/AA	2
DBK060980	DODGE	CARAVAN/VOYAGER	V6 3.3 LTS.	1991-1995	S/AA	2
DBK060988	DODGE	CARAVAN/VOYAGER	V6 3.3 LTS.	1996-2000	S/AA	2
DBK060988	DODGE	CARAVAN/VOYAGER	V6 3.8 LTS.	1996-2000	S/AA	2
DBK060990	DODGE	CARAVAN/VOYAGER	V6 3.3 LTS.	1991-1995	C/AA	2
DBK081102	DODGE	RAM 4000	V6 5.9 LTS. Diesel	2003-2007	S/AA	2

GATES: LA MARCA DE MÁS PRESTIGIO EN BANDAS, MANGUERAS, HIDRÁULICA Y NEUMÁTICA



## Productos Gates \* Características y especificaciones

Kit	Marca	Vehiculo	Motor	Años	Observaciones	Componentes
DBK081265	DODGE	RAM 4000	V6 5.9 LTS. Diesel	2003-2007	C/AA	2
DBK060507	FORD	ESCORT	4 CIL. 2.0 LTS.	1997-2000	SOHC C/AA	3
DBK060532	FORD	FOCUS	4 CIL. 2.0 LTS.	2000-2002	SOHC S/AA	2
DBK060623	FORD	CONTOUR	V6 2.5 LTS.	1995-2000	S/AA	2
DBK060667	FORD	FOCUS	4 CIL. 2.0 LTS.	2003-2004	SOHC C/AA	2
DBK060670	FORD	IKON , K Y FIESTA	4 CIL. 1.6 LTS.	2007-2000	S/AA	2
DBK060680	FORD	FOCUS	4 CIL. 2.0 LTS.	2000-2002	SOHC C/AA	2
DBK060682	FORD	CONTOUR	4 CIL. 2.0 LTS.	1995-1997	S/AA	3
DBK060695	FORD	RANGER	4 CIL. 2.3 LTS.	1995-1997	S/AA	2
DBK060721	FORD	CONTOUR	V6 2.5 LTS.	1995-2000	C/AA	2
DBK060721B	FORD	RANGER	4 CIL. 2.3 LTS.	1992-1994	S/AA	2
DBK060730	FORD	RANGER	4 CIL. 2.3 LTS.	2001-2006	S/AA	2
DBK060733	FORD	CONTOUR	4 CIL. 2.0 LTS.	1995-1997	C/AA	3
DBK060775	FORD	FOCUS	4 CIL. 2.0 LTS.	2000-2002	DOHC S/AA	2
DBK060802	FORD	CONTOUR	4 CIL. 2.0 LTS.	1998-2000	S/AA	2
DBK060806B	FORD	AEROSTAR	V6, 3.0 LTS.	1995-1997	S/AA	3
DBK060810	FORD	AEROSTAR	V6, 4.0 LTS.	1990-1995	S/AA	3
DBK060820	FORD	RANGER	4 CIL. 2.3 LTS.	1995-1997	C/AA	2
DBK060820A	FORD	WINDSTAR	V6, 3.0 LTS.	1995-2000	S/AA	3
DBK060820C	FORD	ESCAPE	4 CIL. 2.3 LTS.	2001-2004	C/AA	2
DBK060827	FORD	FOCUS	4 CIL. 2.0 LTS.	2003-2004	DOHC C/AA	2
DBK060827	FORD	CONTOUR	4 CIL. 2.0 LTS.	1998-2000	C/AA	2
DBK060827B	FORD	RANGER	4 CIL. 2.3 LTS.	2001-2006	C/AA	2
DBK060837	FORD	FOCUS	4 CIL. 2.0 LTS.	2000-2002	DOHC C/AA	2
DBK060837B	FORD	RANGER	4 CIL. 2.3 LTS.	1992-1994	C/AA	2
DBK060840	FORD	ESCAPE	4 CIL. 2.3 LTS.	2005-2006		2
DBK060849	FORD	WINDSTAR	V6, 3.0 LTS.	1995-2000	C/AA	3
DBK060854	FORD	ESCORT	4 CIL. 2.0 LTS.	1997-2000	DOHC	3
DBK060864C	FORD	AEROSTAR	V6, 4.0 LTS.	1995-1997	C/AA	3
DBK060868B	FORD	AEROSTAR	V6, 4.0 LTS.	1990-1995	C/AA	3
DBK060882E	FORD	IKON , K Y FIESTA	4 CIL. 1.6 LTS.	2007-2000	C/AA	2
DBK060960	FORD	FREESTAR	V6, 3.9 LTS.	2004-2007		2
DBK060960A	FORD	WINDSTAR	V6, 3.8 LTS.	1999-2003		3
DBK061066	FORD	AEROSTAR	V6, 3.0 LTS.	1995-1997	C/AA	3
DBK060458	HONDA	ODYSSEY	V6, 3.5 LTS.	1999-2004		2
DBK060461	HONDA	ACCORD	V6, 3.0 LTS.	1998-2002	ALT. / AA	2
DBK060750	JEEP	WRANGLER	6 CIL. 4.0 L	2005-2003	SERPENTIN , S/AA	3

GATES: LA MARCA DE MÁS PRESTIGIO EN BANDAS, MANGUERAS, HIDRÁULICA Y NEUMÁTICA



## Productos Gates \* Características y especificaciones

Kit	Marca	Vehiculo	Motor	Años	Observaciones	Componentes
DBK060750A	JEEP	WRANGLER	V-6, 4.0 L	2004-2004	SERPENTIN , S/AA	3
DBK060790	JEEP	WRANGLER	6 CIL, 4.0 L	2002-1999	SERPENTIN, S/AA	2
DBK060815	JEEP	GRAND CHEROKEE	V-8, 6.1 LTS.	2006-2007	SERPENTIN, C/AA	3
DBK060820B	JEEP	GRAND CHEROKEE	V-8, 5.7 LTS.	2005-2007	SERPENTIN, C/AA	3
DBK060868	JEEP	LIBERTY	V-6, 3.7 L	2004-2006	SERPENTIN	2
DBK060868A	JEEP	GRAND CHEROKEE	V-8, 4.7 L	2004-2007	SERPENTIN, C/AA	3
DBK060868A	JEEP	GRAND CHEROKEE	6 CIL, 3.7 LTS.	2005-2007	SERPENTIN, C/AA	3
DBK060874	JEEP	LIBERTY	V-6, 3.7 L	2002-2003	SERPENTIN, C/AA	2
DBK060874A	JEEP	GRAND CHEROKEE 4 X 4	V-8, 4.7 L	1999-2003	SERPENTIN, C/AA	3
DBK060882A	JEEP	GRAND CHEROKEE	6 CIL, 4.0 L	1999-2004	SERPENTIN, S/AA	3
DBK060882C	JEEP	WRANGLER	6 CIL, 4.0 L	2005-2000	SERPENTIN , C/AA	3
DBK060882C	JEEP	WRANGLER	V-6, 4.0 L	2004-2004	SERPENTIN , C/AA	3
DBK060919	JEEP	WRANGLER	4 CIL, 2.4 L	2004-2003	SERPENTIN, C/AA	3
DBK060755	LINCOLN	LINCOLN CONTINENTAL	V-8, 4.6 L	2002-1998	SERPENTIN	2
DBK060975	LINCOLN	MARK VIII	V-8, 4.6 L	1998-1998	SERPENTIN	3
DBK060975	LINCOLN	TOWN CAR	V-8, 4.6 L	1999-1999	SERPENTIN	3
DBK060984	LINCOLN	NAVIGATOR	V-8, 5.4 L	2002-2002	SERPENTIN	3
DBK070855	LINCOLN	LINCOLN TOWN CAR	V-8, 4.6 L	1992-1991	SERPENTIN	3
DBK080981	LINCOLN	NAVIGATOR	V-8, 5.4 L	2001-2001	SERPENTIN	3
DBK080981	LINCOLN	NAVIGATOR	V-8, 5.4 L	2000-1998	SERPENTIN, C/AA, C/DH	3
DBK060942	MERCEDES BENZ	CLK430	V-8, 4.3 L	2002-1999	SERPENTIN	2
DBK060942	MERCEDES BENZ	CLK55	V-8, 5.5 L	2001-2001	SERPENTIN	2
DBK060942	MERCEDES BENZ	E320	V-6, 3.2 L	2002-1998	SERPENTIN	2
DBK060942	MERCEDES BENZ	E430	V-8, 4.3 L	2001-1999	SERPENTIN	2
DBK060942	MERCEDES BENZ	E55	V-8, 5.5 L	2001-1999	SERPENTIN	2
DBK060942	MERCEDES BENZ	ML	V-6, 3.2 L	1998-1998	SERPENTIN	2
DBK060942	MERCEDES BENZ	ML430	V-8, 4.3 L	2001-1999	SERPENTIN	2
DBK060942	MERCEDES BENZ	ML55	V-8, 5.5 L	2001-2000	SERPENTIN	2
DBK060942	MERCEDES BENZ	S430	V-8, 4.3 L	2002-2000	SERPENTIN	2
DBK060942	MERCEDES BENZ	S500	V-8, 5.0 L	2001-1999	SERPENTIN	2
DBK060942	MERCEDES BENZ	S500 L	V-8, 5.0 L	2000-1998	SERPENTIN	2
DBK060942	MERCEDES BENZ	S55	V-8, 5.5 L	2001-2001	SERPENTIN	2
DBK060942	MERCEDES BENZ	C240	V-6, 2.6 L	2002-2001	SERPENTIN	2
DBK060942	MERCEDES BENZ	C280T	V-6, 2.8 L	1998-1998	SERPENTIN	2
DBK060942	MERCEDES BENZ	C320	V-6, 3.2 L	2001-2001	SERPENTIN	2
DBK060942	MERCEDES BENZ	CL500	V-8, 5.0 L	2001-1999	SERPENTIN	2
DBK060942	MERCEDES BENZ	CL55	V-8, 5.5 L	2001-2001	SERPENTIN	2

GATES: LA MARCA DE MÁS PRESTIGIO EN BANDAS, MANGUERAS, HIDRÁULICA Y NEUMÁTICA



## Productos Gates \* Características y especificaciones

Kit	Marca	Vehiculo	Motor	Años	Observaciones	Componentes
DBK060942A	MERCEDES BENZ	ML320	V-6, 3.2 L	2002-1999	SERPENTIN	3
DBK060942A	MERCEDES BENZ	SL500	V-8, 5.0 L	2001-1999	SERPENTIN	3
DBK060942A	MERCEDES BENZ	C280	V-6, 2.8 L	1999-1998	SERPENTIN	3
DBK060942A	MERCEDES BENZ	C43	V-8, 4.3 L	2000-1999	SERPENTIN	3
DBK060942A	MERCEDES BENZ	CLK320	V-6, 3.2 L	2002-1999	SERPENTIN	3
DBK060623A	MERCURY	MYSTIQUE	V-6, 2.5 L, DURATEC, DOHC	2000-1995	SERPENTIN, S/AA	3
DBK060682	MERCURY	MYSTIQUE	4 CIL, 2.0 L, ZETEC, DOHC	1997-1996	SERPENTIN, S/AA	3
DBK060716	MERCURY	MYSTIQUE	V-6, 2.5 L, DURATEC, DOHC	2000-1995	SERPENTIN, C/AA	3
DBK060721A	MERCURY	MYSTIQUE	V-6, 2.5 L, DURATEC, DOHC	2000-1997	SERPENTIN, C/AA	3
DBK060733	MERCURY	MYSTIQUE	4 CIL, 2.0 L, ZETEC, DOHC	1997-1996	SERPENTIN, C/AA	3
DBK060802A	MERCURY	MYSTIQUE	4 CIL, 2.0 L, ZETEC, DOHC	2000-1999	SERPENTIN, S/AA	3
DBK060815C	MERCURY	SABLE	V-6, 3.0 L	2003-2001	SERPENTIN , C/AA 24V.	2
DBK060827A	MERCURY	MYSTIQUE	4 CIL, 2.0 L, ZETEC, DOHC	2000-1999	SERPENTIN, C/AA	3
DBK060832	MERCURY	MYSTIQUE	4 CIL, 2.0 L, ZETEC, DOHC	1998-1998	SERPENTIN, C/AA >FEB 1998	3
DBK060854A	MERCURY	SABLE	V-6, 3.0 L, OHV	2000-1999	SERPENTIN 12 V.	3
DBK060854A	MERCURY	SABLE	V-6, 3.0 L, DURATEC, DOHC	1999-1999	SERPENTIN, C/AA	3
DBK060854B	MERCURY	SABLE	V-6, 3.0 L, OHV	2000-2000	SERPENTIN	3
DBK060858	MERCURY	SABLE	V-6, 3.0 L, OHV	2002-2001	SERPENTIN, S/motor HV	2
DBK060858	MERCURY	SABLE	V-6, 3.0 L, DURATEC, SOHC	1998-1998	SERPENTIN OHV	2
DBK060858	MERCURY	SABLE LS	V-6, 3.0 L, DURATEC, OVH	2001-2000	SERPENTIN	2
DBK060858A	MERCURY	MYSTIQUE	4 CIL, 2.0 L, ZETEC, DOHC	1998-1998	SERPENTIN, C/AA, < ENE	3
DBK060975	MERCURY	GRAND MARQUIS	V-8, 4.6 L	1999-1995	SERPENTIN	3
DBK070855	MERCURY	GRAND MARQUIS	V-8, 4.6 L	1994-1992	SERPENTIN, ALT. C/86 3/8"	3
DBK050435	NISSAN	PLATINA	4 CIL, 1.6 L	2002-2008	S/AA	2
DBK050688	NISSAN	PLATINA	4 CIL, 1.6 L	2002-2008	c/AA	2
DBK060883	NISSAN	ALTIMA	4 CIL, 2.4 L	2004-2003	SERPENTIN	2
DBK060883	NISSAN	SENTRA	4 CIL, 2.5 L	2004-2003	SERPENTIN	2
DBK060695B	OLDSMOBILE	SILHOUETTE	V-6, 3.1 L	1993-1992	SERPENTIN	2
DBK060938	OLDSMOBILE	LSS	V-6, 3.8 L	1999-1999	SERPENTIN	2
DBK061025	OLDSMOBILE	SILHOUETTE	V-6, 3.8 L	1994-1993	SERPENTIN, ALT.105 Amp	2
DBK060420	PEUGEOT	306	4 CIL, 2.0 L, XU10J4R	2001-1999	SERPENTIN, S/AA	2
DBK060425B	PEUGEOT	306	4 CIL, 1.8 L, XU7JP4	2001-1999	SERPENTIN, S/AA	2
DBK060570	PEUGEOT	206	4 CIL, 1.6 L, TU5JP4	2001-1999	SERPENTIN, S/AA	2
DBK060615	PEUGEOT	206	4 CIL, 1.4 L	2004-1999	SERPENTIN, C/AA & C/DH	2
DBK060615	PEUGEOT	206	4 CIL, 1.6 L	2004-1999	SERPENTIN, C/AA & C/DH	2
DBK060630	PEUGEOT	306	4 CIL, 2.0 L, XU10J4R	2001-1999	SERPENTIN, C/AA	2
DBK060653	PEUGEOT	306	4 CIL, 1.8 L, XU7JP4	2001-1999	SERPENTIN, C/AA	3

GATES: LA MARCA DE MÁS PRESTIGIO EN BANDAS, MANGUERAS, HIDRÁULICA Y NEUMÁTICA



## Productos Gates \* Características y especificaciones

Kit	Marca	Vehiculo	Motor	Años	Observaciones	Componentes
DBK040410	PONTIAC	TRANS AM FIREBIRD	V-8, 5.7 L	2001-1998	SERPENTIN, A.A.	2
DBK050345	PONTIAC	SUNFIRE	4 CIL, 2.2 L	2004-2004	SERPENTIN S/AA	3
DBK050345	PONTIAC	G5	4-Cyl, 2.4 L	2005-2007	S/AA	3
DBK050400	PONTIAC	SUNFIRE	4 CIL, 2.2 LTS.	2002-2005		2
DBK050400A	PONTIAC	SUNFIRE	4 CIL, 2.2 L	2005-2005	SERPENTIN	3
DBK050400A	PONTIAC	SUNFIRE	4 CIL, 2.2 L, MOTOR # SERIE F	2002-2002	SERPENTIN, C/AA; Motor # serie F	3
DBK050400A	PONTIAC	SUNFIRE	4 CIL, 2.2 L	2004-2004	SERPENTIN C/AA	3
DBK050400A	PONTIAC	G5	4-Cyl, 2.2 L	2005-2007	C/AA	3
DBK050405	PONTIAC	G6	4-Cyl, 2.4 L	2005-2007		3
DBK050474	PONTIAC	SUNFIRE	4 CIL, 2.4 L, MFI PRIMER DISEÑO	1999-1996	SERPENTIN	3
DBK050630	PONTIAC	SUNFIRE	4 CIL, 2.2 L	2002-1998	SERPENTIN, S/AA; Motor # de serie 4	3
DBK050705	PONTIAC	SUNFIRE	4 CIL, 2.2 L, MFI	1997-1995	SERPENTIN, S/AA	3
DBK050835	PONTIAC	SUNFIRE	4 CIL, 2.2 L, MFI	1997-1995	SERPENTIN, C/AA	3
DBK050887	PONTIAC	SUNFIRE	4 CIL, 2.2 L, MOTOR SERIE 4	2002-1998	SERPENTIN, C/AA; Motor serie 4	3
DBK050887	PONTIAC	SUNFIRE	4 CIL, 2.2 LTS.	1998-2002		3
DBK060642	PONTIAC	TRANS AM FIREBIRD	V-8, 5.7 L	1997-1995	SERPENTIN	2
DBK060721C	PONTIAC	BONNEVILLE SSE	V-6, 3.8 L	1999-1998	SERPENTIN - SUPERCARGADOR	3
DBK060790B	PONTIAC	TRANS AM FIREBIRD	V-8, 5.7 L	2001-1998	SERPENTIN ACCESORIOS	2
DBK060864	PONTIAC	AZTEK	V-6, 3.4 L	2005-2001	SERPENTIN	2
DBK060864B	PONTIAC	MONTANA	V-6 3.4 L	2005-2003	C/105A ALT.	3
DBK060875	PONTIAC	MONTANA	V-6 3.4 L	2005-2003	C/130A ALT.	3
DBK060888	PONTIAC	MONTANA	V-6 3.5 L	2006-2005		3
DBK060905	PONTIAC	TORRENT	V-6 3.4 L	2006-2006		3
DBK060935	PONTIAC	G6	V-6 3.6 L	2007-2007		3
DBK060938A	PONTIAC	BONNEVILLE SSE	V-6, 3.8 L	1999-1998	SERPENTIN	3
DBK050435	RENAULT	CLIO / KANGOO	4 CIL, 1.6 L	2002-2008	S/AA	2
DBK050688	RENAULT	CLIO / KANGOO	4 CIL, 1.6 L	2002-2008	C/AA	2
DB6DPK1200	SEAT	LEON	4 CIL, 1.8 L, TURBO	2003-2003	SERPENTIN , ALT., C/AA	2
DB6DPK1200	SEAT	TOLEDO	4 CIL, 1.8 L	2003-2003	SERPENTIN , ALT., C/AA	2
DBK060295	SEAT	IBIZA	4 CIL, 1.6L	2005-2003	SERPENTIN , S/AA, C/DH	2
DBK060365	SEAT	IBIZA	4 CIL, 2.0 L	2005-2003	SERPENTIN , S/AA	2
DBK060367	SEAT	CORDOBA	4 CIL, 2.0 L	2004-2004	SERPENTIN , ALT. S/AA	2
DBK060406	SEAT	IBIZA	4 CIL, 2.0 L	2005-2003	SERPENTIN , C/AA	2
DBK060408	SEAT	CORDOBA	4 CIL, 2.0 L	2004-2004	SERPENTIN , ALT. C/AA	2
DBK060425	SEAT	CORDOBA	4 CIL, 1.6 L	2005-2001	SERPENTIN , ALT. C/AA	2
DBK060425	SEAT	IBIZA	4 CIL, 1.6L	2005-2003	SERPENTIN , C/AA, C/DH	2
DBK060445	SEAT	LEON	4 CIL, 1.8 L, TURBO	2003-2003	SERPENTIN , ALT., S/AA	2

GATES: LA MARCA DE MÁS PRESTIGIO EN BANDAS, MANGUERAS, HIDRÁULICA Y NEUMÁTICA



## Productos Gates \* Características y especificaciones

Kit	Marca	Vehiculo	Motor	Años	Observaciones	Componentes
DBK060445	SEAT	TOLEDO	4 CIL, 1.8 L	2003-2003	SERPENTIN , ALT., S/AA	2
DB6DPK1200	VOLKSWAGEN	SHARAN	4 CIL, 1.8 L	2003-2006	SERPENTIN , C/AA	2
DB6DPK1200A	VOLKSWAGEN	BEETLE	4 CIL, 1.8 L	2005-2000	SERPENTIN, C/AA, C/BANDA DE DOBLE PERFIL	3
DB6DPK1200A	VOLKSWAGEN	BEETLE	4 CIL, 2.0 L	2005-2000	SERPENTIN , C/AA	3
DB6DPK1200A	VOLKSWAGEN	GOLF	4 CIL, 1.8 L, TURBO	2005-2001	SERPENTIN , C/AA	3
DB6DPK1200A	VOLKSWAGEN	GOLF	4 CIL, 2.0 L	2005-2000	SERPENTIN, C/AA	3
DB6DPK1200A	VOLKSWAGEN	JETTA	4 CIL, 1.8 L	2005-2000	SERPENTIN	3
DB6DPK1200A	VOLKSWAGEN	JETTA	4 CIL, 2.0 L	2005-1999	SERPENTIN , C/AA	3
DB7DPK1360	VOLKSWAGEN	JETTA	V-6, 2.8 L	2004-1999	SERPENTIN, C/BANDA DE DOBLE PERFIL, C/7 COSTILLAS	2
DBK050510	VOLKSWAGEN	PASSAT	4 CIL, 1.8 L, DOHC TURBO	2005-1999	SERPENTIN , P/ALT, DIR. HIDR. Y VENT.	3
DBK060297	VOLKSWAGEN	POLO	4 CIL, 1.6 L	2003-2006	SERPENTIN, S/AA	2
DBK060355	VOLKSWAGEN	CABRIO	4 CIL, 2.0 L, MPFI	1995-1995	SERPENTIN, ALT. & B.A. S/AA, S/ALT. 120A	3
DBK060365B	VOLKSWAGEN	PANEL	4 CIL, 1.8 L	2001-1996	SERPENTIN, ALT., C/RAD	2
DBK060385	VOLKSWAGEN	CABRIO	4 CIL, 2.0 L, MPFI	2002-1995	SERPENTIN, B.A. & ALT., S/AA	3
DBK060385	VOLKSWAGEN	GOLF	4 CIL, 2.0 L, MPFI	2000-1999	BANDA B.A. & ALT., S/AA; S/BANDA DE DOBLE PERFIL	3
DBK060385	VOLKSWAGEN	JETTA	4 CIL, 2.0 L	1994-1994	SERPENTIN, ALT. & B.A. S/AA, C/ALT 120A	3
DBK060385	VOLKSWAGEN	JETTA	4 CIL, 2.0 L	2000-1999	SERPENTIN, ALT. & B.A. S/AA	3
DBK060406	VOLKSWAGEN	POLO	4 CIL, 2.0 L	2003-2006	SERPENTIN , C/AA	2
DBK060408A	VOLKSWAGEN	JETTA	4 CIL, 2.0 L	2000-1996	SERPENTIN, ALT., S/AA, S/DH	3
DBK060420B	VOLKSWAGEN	LUPO	4 CIL, 1.6 L	2006-2004	SERPENTIN, C/DH Y S/AA	2
DBK060424	VOLKSWAGEN	POLO	4 CIL, 1.6 L	2003-2006	SERPENTIN, C/AA	2
DBK060441	VOLKSWAGEN	GOLF	4 CIL, 2.0 L	2005-2003	SERPENTIN , S/AA	3
DBK060454	VOLKSWAGEN	CABRIO GL, GLS	4 CIL, 2.0 L, MPFI	2000-2000	SERPENTIN, ALT., C/AA, C/DH	3
DBK060455	VOLKSWAGEN	CABRIO	4 CIL, 2.0 L, MPFI	2002-1995	BANDA ALT. & A.A.	3
DBK060455	VOLKSWAGEN	JETTA	4 CIL, 2.0 L	2000-2000	BANDA ALT. & A.A., S/MICRO V DE DOBLE PERFIL	3
DBK060455B	VOLKSWAGEN	VW VAN	4 CIL, 1.6 L	2003-2006	SERPENTIN , C/AA	2
DBK060669	VOLKSWAGEN	LUPO	4 CIL, 1.6 L	2006-2004	SERPENTIN, C/DH Y C/AA	2
DBK060683	VOLKSWAGEN	POINTER	4 CIL, 1.8 L	2001-2008	SERPENTIN, ALT., S/AA	2
DBK060683	VOLKSWAGEN	POINTER PICK-UP	4 CIL, 1.8 L	2005-2008	SERPENTIN, S/AA	2
DBK060739	VOLKSWAGEN	JETTA	V-6, 2.8 L	2002-2002	SERPENTIN, S/AA	2
DBK060894	VOLKSWAGEN	POINTER	4 CIL, 1.8 L, MFI	2001-2008	SERPENTIN, C/AA, C/DH	2
DBK060894	VOLKSWAGEN	POINTER PICK-UP	4 CIL, 1.8 L, MFI	2001-1999	SERPENTIN, C/AA, C/DH	2
DBK060894	VOLKSWAGEN	POINTER STATION WAGON	4 CIL, 1.8 L, MFI	2001-1999	SERPENTIN, C/AA, C/DH	2

GATES: LA MARCA DE MÁS PRESTIGIO EN BANDAS, MANGUERAS, HIDRÁULICA Y NEUMÁTICA



## Productos Gates \* Características y especificaciones

### Kits para bandas Micro-V® DriveAlign®

#### Componentes iguales a los de equipo original:

- Tensor con resorte helicoidal DriveAlign®, eliminan el ruido, la vibración y el desgaste de la transmisión.



- Banda Micro-V® AT con la mejor tecnología del mercado (Más silenciosa y mayor duración).



GATES: LA MARCA DE MÁS PRESTIGIO EN BANDAS, MANGUERAS, HIDRÁULICA Y NEUMÁTICA





Productos Gates \* Características y especificaciones

**Tabla de Aplicaciones de kits para PowerGrip®**



Kit	Marca	Vehículo	Motor	Años	Observaciones	Componentes
TCK184	ACURA	INTEGRA	4 CIL, 1.8 L	1999-2001		2
TCK193	ACURA	TL	V-6, 3.2 L	1998-1998		2
TCK247	ACURA	INTEGRA	4 CIL, 1.8 L	2001-1999	C/VTEC MOTOR.	2
TCK286	ACURA	TL	V-6, 3.2 L	2000-1999		3
TCK244	ACURA	CL	4 CIL, 2.3 L	1998-1999		4
TCK297	AUDI	A8	V-8, 4.2 L	2007-2007		3
TCK285	CADILLAC	CATERA	V-6, 3.0 L	1998-1999		4
TCK285A	CADILLAC	CATERA	V-6, 3.0 L	2000-1999	Late	4
TCK1022	CHEVROLET	ASTRA	4 CIL, 2.0 L	2004-2005		2
TCK1022	CHEVROLET	ZAFIRA	4 CIL, 2.0 L	2005-2006		2
TCK164	CHEVROLET	TRACKER	4 CIL, 1.6 L	1991-1992		2
TCK212	CHEVROLET	TRACKER	4 CIL, 1.6 L	2001-2002		2
TCK305	CHEVROLET	ASTRA	4 CIL, 2.4 L	2006-2004		2
TCK305	CHEVROLET	ZAFIRA	4 CIL, 2.4 L	2006-2004		2
TCK203	CHEVROLET	CHEVY	4 CIL, 1.6 L	1999-1997		3
TCK203	CHEVROLET	CHEVY C2	4 CIL, 1.6 L	2007-2004		3
TCK203	CHEVROLET	CHEVY C2 SEDAN	4 CIL, 1.6 L	2007-2006		3
TCK203	CHEVROLET	CHEVY JOY	4 CIL, 1.6 L	2000-1998		3
TCK203	CHEVROLET	CHEVY PICK-UP	4 CIL, 1.6 L	2002-2004		3
TCK203	CHEVROLET	CHEVY POP	4 CIL, 1.6 L	1998-1996		3
TCK203	CHEVROLET	CHEVY SWING	4 CIL, 1.6 L	2000-1997		3
TCK203	CHEVROLET	MONZA	4 CIL, 1.6 L	2002-1994		3
TCK192	CHEVROLET	LUMINA	V-6, 3.4 L	1993-1991		4
TCK273	CHEVROLET	LUMINA	V-6, 3.4 L	1996-1997		4
TCK1094	CHEVROLET	ASTRA	4 CIL, 1.8 L	2000-2003		4
TCK1094	CHEVROLET	ZAFIRA	4 CIL, 1.8 L	2003-2001		4
TCK309	CHEVROLET	OPTRA	4 CIL, 2.0 L	2008-2006		4
TCK139	CHRYSLER	DAYTONA	V-6, 3.0 L	1993-1990		2
TCK139	CHRYSLER	GRAND VOYAGER	V-6, 3.0 L	1996-2001		2
TCK139	CHRYSLER	GRAND VOYAGER	V-6, 3.3 L	2000-2000		2
TCK139	CHRYSLER	LEBARON	V-6, 3.0 L	1991-1990		2

GATES: LA MARCA DE MÁS PRESTIGIO EN BANDAS, MANGUERAS, HIDRÁULICA Y NEUMÁTICA



## Productos Gates \* Características y especificaciones

Kit	Marca	Vehículo	Motor	Años	Observaciones	Componentes
TCK139	CHRYSLER	TOWN & COUNTRY VAN	V-6, 3.0 L	1990-1990		2
TCK139	CHRYSLER	VOYAGER	V-6, 3.0 L	1997-2000		2
TCK153	CHRYSLER	DAYTONA	4 CIL, 2.2 L	1990-1990		2
TCK153	CHRYSLER	DAYTONA	4 CIL, 2.5 L	1990-1993		2
TCK153	CHRYSLER	LEBARON	4 CIL, 2.2 L	1990-1990		2
TCK153	CHRYSLER	LEBARON	4 CIL, 2.5 L	1993-1992		2
TCK219	CHRYSLER	CONCORDE	V-6, 3.5 L	1993-1994		2
TCK219	CHRYSLER	INTREPID	V-6, 3.5 L	1994-1993		2
TCK219	CHRYSLER	LHS	V-6, 3.5 L	1994-1994		2
TCK219	CHRYSLER	NEW YORKER	V-6, 3.5 L	1994-1994		2
TCK245	CHRYSLER	CIRRUS	4 CIL, 2.0 L	2000-2000	C/Hyd. TENSOR	2
TCK255	CHRYSLER	CONCORDE	V-6, 3.5 L	1997-1995		2
TCK255	CHRYSLER	INTREPID	V-6, 3.5 L	1997-1995		2
TCK255	CHRYSLER	LHS	V-6, 3.5 L	1995-1997		2
TCK255	CHRYSLER	NEW YORKER	V-6, 3.5 L	1995-1996		2
TCK295	CHRYSLER	300M	V-6, 3.5 L	2002-1999		2
TCK295	CHRYSLER	CONCORDE	V-6, 3.2 L	2001-2000		2
TCK295	CHRYSLER	CONCORDE	V-6, 3.5 L	2002-2002		2
TCK295	CHRYSLER	INTREPID	V-6, 3.2 L	1999-1998		2
TCK295	CHRYSLER	INTREPID	V-6, 3.5 L	2000-2001		2
TCK295	CHRYSLER	LHS	V-6, 3.5 L	2000-1999		2
TCK246	CHRYSLER	SEBRING	4 CIL, 2.0 L	1995-1999	C/DOHC MOTOR.; C/Hyd. TENSOR	3
TCK259	CHRYSLER	CIRRUS	V-6, 2.5 L	1998-1999		3
TCK259	CHRYSLER	SEBRING	V-6, 2.5 L	1998-1997		3
TCK259	CHRYSLER	SEBRING	V-6, 3.0 L	2004-2001		3
TCK139	DODGE	CARAVAN	V-6, 3.0 L	1993-1995		2
TCK139	DODGE	GRAND CARAVAN	V-6, 3.0 L	1992-2001		2
TCK139	DODGE	SPIRIT	V-6, 3.0 L	1995-1994		2
TCK153	DODGE	CARAVAN	4 CIL, 2.5 L	1995-1995		2
TCK153	DODGE	DAKOTA	4 CIL, 2.5 L	1995-1995		2
TCK153	DODGE	SHADOW	4 CIL, 2.2 L	1994-1994		2
TCK153	DODGE	SHADOW	4 CIL, 2.5 L	1994-1994		2
TCK153	DODGE	SPIRIT	4 CIL, 2.5 L	1994-1995		2
TCK245	DODGE	NEON	4 CIL, 2.0 L	1996-2002	C/Hyd. TENSOR	2
TCK245	DODGE	STRATUS	4 CIL, 2.0 L	1995-2000		2
TCK255	DODGE	INTREPID	V-6, 3.5 L	1996-1997		2
TCK295	DODGE	INTREPID	V-6, 3.2 L	1998-2001		2

GATES: LA MARCA DE MÁS PRESTIGIO EN BANDAS, MANGUERAS, HIDRÁULICA Y NEUMÁTICA



## Productos Gates \* Características y especificaciones

Kit	Marca	Vehículo	Motor	Años	Observaciones	Componentes
TCK295	DODGE	INTREPID	V-6, 3.5 L	2000-2002		2
TCK246	DODGE	NEON	4 CIL, 2.0 L	1998-1999	C/DOHC MOTOR.; C/Hyd. TENSOR	3
TCK259	DODGE	STRATUS	V-6, 2.5 L	1997-1999		3
TCK259	DODGE	STRATUS	V-6, 3.0 L	2004-2001		3
TCK194	FORD	ESCORT	4 CIL, 1.9 L	1996-1994		2
TCK210	FORD	RANGER	4 CIL, 2.3 L	1994-1994		2
TCK276	FORD	RANGER	4 CIL, 2.3 L	1995-2001		2
TCK276	FORD	RANGER	4 CIL, 2.5 L	2001-2000		2
TCK283	FORD	ESCORT	4 CIL, 2.0 L	1998-1997		2
TCK283	FORD	FOCUS	4 CIL, 2.0 L	2004-2001		2
TCK179	FORD	ESCORT	4 CIL, 1.8 L	1996-1994		3
TCK283	FORD	ESCORT	4 CIL, 2.0 L	2002-1997	C/SOHC MOTOR.	3
TCK294B	FORD	ESCAPE	4 CIL, 2.0 L	2002-2004		3
TCK258	FORD	CONTOUR	4 CIL, 2.0 L	1997-1995		4
TCK294	FORD	CONTOUR	4 CIL, 2.0 L	1998-1999		4
TCK294	FORD	ESCORT	4 CIL, 2.0 L	1998-2000		4
TCK294A	FORD	CONTOUR	4 CIL, 2.0 L	1999-2000		4
TCK294A	FORD	ESCORT	4 CIL, 2.0 L	2000-1999		4
TCK294A	FORD	FOCUS	4 CIL, 2.0 L	2000-2006		4
TCK294A	FORD	ZX2	4 CIL, 2.0 L	2003-2003		4
TCK250	FORD	CONTOUR	4 CIL, 2.0 L	1997-1997	Motor de interferencia	2
TCK143	HONDA	CIVIC	4 CIL, 1.5 L	1995-1995		2
TCK143	HONDA	CIVIC DEL SOL	4 CIL, 1.5 L	1995-1995		2
TCK184	HONDA	CR-V	4 CIL, 2.0 L	2001-1999		2
TCK224	HONDA	CIVIC	4 CIL, 1.6 L	1997-1995	C/SOHC MOTOR.	2
TCK224	HONDA	CIVIC DEL SOL	4 CIL, 1.6 L	1997-1996		2
TCK227	HONDA	CIVIC	4 CIL, 1.6 L	2000-1999		2
TCK227	HONDA	CIVIC DEL SOL	4 CIL, 1.6 L	1997-1995		2
TCK221	HONDA	PASSPORT	V-6, 3.2 L	1997-1997		3
TCK286	HONDA	ACCORD	V-6, 3.0 L	2000-2001		3
TCK186	HONDA	ACCORD	4 CIL, 2.2 L	1996-1997		4
TCK186	HONDA	ODYSSEY	4 CIL, 2.2 L	1996-1997		4
TCK244	HONDA	ACCORD	4 CIL, 2.2 L	1995-1996		4
TCK244	HONDA	ACCORD	4 CIL, 2.3 L	1998-1999		4
TCK244	HONDA	ODYSSEY	4 CIL, 2.3 L	1998-1998		4
TCK1013M	HYUNDAI	ATOS	4 CIL, 1.0 L	2004-2000		2
TCK1013M	HYUNDAI	ATOS	4 CIL, 1.1 L	2008-2005		2

GATES: LA MARCA DE MÁS PRESTIGIO EN BANDAS, MANGUERAS, HIDRÁULICA Y NEUMÁTICA



## Productos Gates \* Características y especificaciones

Kit	Marca	Vehículo	Motor	Años	Observaciones	Componentes
TCK124M	HYUNDAI	H100	4 CIL, 2.4 L	2005-2003		2
TCK324M	HYUNDAI	ACCENT	4 CIL, 1.5 L	2003-2000		2
TCK324M	HYUNDAI	ACCENT	4 CIL, 1.6 L	2006-2001		2
TCK324M	HYUNDAI	ATTITUD	4 CIL, 1.6 L	2007-2006		2
TCK324M	HYUNDAI	ATTITUDE	4 CIL, 1.6 L	2007-2006		2
TCK324M	HYUNDAI	VERNA	4 CIL, 1.5 L	2007-2004		2
TCK324M	HYUNDAI	VERNA	4 CIL, 1.6 L	2006-2005		2
TCK282M	HYUNDAI	ACCENT	4 CIL, 1.5 L	2003-2000		3
TCK282M	HYUNDAI	ACCENT	4 CIL, 1.6 L	2006-2001		3
TCK282M	HYUNDAI	ATTITUD	4 CIL, 1.6 L	2007-2006		3
TCK282M	HYUNDAI	ATTITUDE	4 CIL, 1.6 L	2007-2006		3
TCK282M	HYUNDAI	VERNA	4 CIL, 1.5 L	2007-2004		3
TCK282M	HYUNDAI	VERNA	4 CIL, 1.6 L	2006-2005		3
TCK282M	HYUNDAI	ACCENT	4 CIL, 1.6 L	2006-2001		3
TCK179	MAZDA	MX-5 MIATA	4 CIL, 1.8 L	2005-2005		3
TCK258	MERCURY	MYSTIQUE	4 CIL, 2.0 L	1996-1997		4
TCK294	MERCURY	MYSTIQUE	4 CIL, 2.0 L	1998-1999		4
TCK294A	MERCURY	COUGAR	4 CIL, 2.0 L	1999-2003		4
TCK294A	MERCURY	MYSTIQUE	4 CIL, 2.0 L	1999-2000		4
TCK259	MITSUBISHI	ECLIPSE	V-6, 3.0 L	2005-2000		3
TCK259	MITSUBISHI	GALANT	V-6, 3.0 L	2000-2003		3
TCK259	MITSUBISHI	MONTERO SPORT	V-6, 3.0 L	2000-2003		3
TCK287	MITSUBISHI	DIAMANTE	V-6, 3.5 L	2000-2004		3
TCK287	MITSUBISHI	ENDEAVOR	V-6, 3.8 L	2006-2004		3
TCK287	MITSUBISHI	GALANT	V-6, 3.8 L	2004-2006		3
TCK287	MITSUBISHI	MONTERO	V-6, 3.5 L	2000-2000		3
TCK287	MITSUBISHI	MONTERO SPORT	V-6, 3.5 L	2000-2002		3
TCK104	NISSAN	MAXIMA	V-6, 3.0 L	1990-1994	C/Square Tooth Sprockets	2
TCK104	NISSAN	PATHFINDER	V-6, 3.0 L	1990-1991		2
TCK104	NISSAN	PICK-UP	V-6, 3.0 L	1992-1990		2
TCK104	NISSAN	QUEST	V-6, 3.0 L	1994-1993		2
TCK249	NISSAN	FRONTIER	V-6, 3.3 L	1999-2001	Motor de interferencia	2
TCK249	NISSAN	MAXIMA	V-6, 3.0 L	1994-1993		2
TCK249	NISSAN	PATHFINDER	V-6, 3.0 L	1994-1995		2
TCK249	NISSAN	PATHFINDER	V-6, 3.3 L	1996-1997		2
TCK249	NISSAN	PICK-UP	V-6, 3.0 L	1993-1995		2
TCK249	NISSAN	QUEST	6 CIL, 3.3 L	2002-2002		2

GATES: LA MARCA DE MÁS PRESTIGIO EN BANDAS, MANGUERAS, HIDRÁULICA Y NEUMÁTICA



## Productos Gates \* Características y especificaciones

Kit	Marca	Vehículo	Motor	Años	Observaciones	Componentes
TCK249	NISSAN	QUEST	V-6, 3.0 L	1994-1998		2
TCK249	NISSAN	QUEST	V-6, 3.3 L	2002-2000		2
TCK249	NISSAN	XTERRA	V-6, 3.3 L	2004-2000		2
TCK1095	NISSAN	APRIO	4 CIL, 1.6 L	2008-2008		4
TCK1095	NISSAN	PLATINA	4 CIL, 1.6 L	2004-2008		4
TCK1095M	NISSAN	APRIO	4 CIL, 1.6 L	2008-2008		4
TCK1095M	NISSAN	PLATINA	4 CIL, 1.6 L	2003-2007		4
TCK1095M	NISSAN	APRIO	4 CIL, 1.6 L	2008-2008		4
TCK1095M	NISSAN	PLATINA	4 CIL, 1.6 L	2008-2002		4
TCK901	PEUGEOT	206	4 CIL, 1.4 L	2001-1998	108 Dientes y 17mm de Ancho	2
TCK901A	PEUGEOT	206	4 CIL, 1.4 L	2003-2008	104 Dientes y 17mm de Ancho	2
TCK192	PONTIAC	GRAND PRIX	V-6, 3.4 L	1995-1995		4
TCK273	PONTIAC	GRAND PRIX	V-6, 3.4 L	1996-1996		4
TCK1284	RENAULT	MEGAN I	4 CIL, 2.0 L	2001-2003		2
TCK1565	RENAULT	MEGAN II	4 CIL, 2.0 L	2005-2006		2
TCK1095M	RENAULT	CLIO	4 CIL, 1.6 L	2003-2008		4
TCK1095M	RENAULT	KANGOO	4 CIL, 1.6 L	2006-2005		4
TCK1095M	RENAULT	KANGOO EXPRESS	4 CIL, 1.6 L	2005-2007		4
TCK1095M	RENAULT	CLIO	4 CIL, 1.6 L	2008-2003		4
TCK1095M	RENAULT	KANGOO	4 CIL, 1.6 L	2008-2005		4
TCK1095M	RENAULT	KANGOO EXPRESS	4 CIL, 1.6 L	2008-2005		4
TCK285	SAAB	09-May	V6, 3.0 L	2002-2003		4
TCK285	SAAB	09-May	V-6, 3.0 L	2000-2003		4
TCK1548	SEAT	CORDOBA	4 CIL, 1.6 L	2007-2004		2
TCK1548	SEAT	IBIZA	4 CIL, 1.6 L	2006-2003		2
TCK199	TOYOTA	CAMRY	4 CIL, 2.2 L	2000-2001		3
TCK199	TOYOTA	CAMRY SOLARA	4 CIL, 2.2 L	2000-2000		3
TCK199	TOYOTA	RAV 4	4 CIL, 2.0 L	2000-2000		3
TCK199	TOYOTA	SOLARA	4 CIL, 2.2 L	2001-2001		3
TCK257	TOYOTA	AVALON	V-6, 3.0 L	2000-2004		3
TCK257	TOYOTA	CAMRY	V-6, 3.0 L	2002-2000		3
TCK257	TOYOTA	CAMRY SOLARA	V-6, 3.0 L	2000-2000		3
TCK257	TOYOTA	SIENNA	V-6, 3.0 L	2003-2002		3
TCK257	TOYOTA	SOLARA	V-6, 3.0 L	2002-2001		3
TCK271	TOYOTA	4 RUNNER	V-6, 3.4 L	2000-1997		3
TCK271	TOYOTA	T100	V-6, 3.4 L	1998-1998		3
TCK271	TOYOTA	TACOMA	V-6, 3.4 L	2001-2003		3

GATES: LA MARCA DE MÁS PRESTIGIO EN BANDAS, MANGUERAS, HIDRÁULICA Y NEUMÁTICA



## Productos Gates \* Características y especificaciones

Kit	Marca	Vehículo	Motor	Años	Observaciones	Componentes
TCK271	TOYOTA	TUNDRA	V-6, 3.4 L	2000-2002		3
TCK298	TOYOTA	LAND CRUISER	V-8, 4.7 L	2007-2007		3
TCK298	TOYOTA	TUNDRA	V-8, 4.7 L	2007-2008		3
TCK017	VOLKSWAGEN	GOLF	4 CIL, 1.8 L	1995-1995		2
TCK017	VOLKSWAGEN	GOLF GTI SPECIAL	4 CIL, 1.8 L	1992-1992		2
TCK017	VOLKSWAGEN	JETTA	4 CIL, 1.8 L	1990-1992		2
TCK017	VOLKSWAGEN	JETTA GL	4 CIL, 1.8 L	1991-1992		2
TCK017	VOLKSWAGEN	JETTA GLI	4 CIL, 1.8 L	1990-1991		2
TCK1548	VOLKSWAGEN	CROSSFOX	4 CIL, 1.6 L	2008-2005		2
TCK1548	VOLKSWAGEN	LUPO	4 CIL, 1.6 L	2006-2008		2
TCK1548	VOLKSWAGEN	POLO	4 CIL, 1.6 L	2007-2005		2
TCK1548	VOLKSWAGEN	SPORT VAN	4 CIL, 1.6 L	2007-2006		2
TCK1548	VOLKSWAGEN	SPORTVAN	4 CIL, 1.6 L	2008-2006		2
TCK260M	VOLKSWAGEN	CABRIO	4 CIL, 2.0 L	1995-1995		2
TCK260M	VOLKSWAGEN	CABRIO	4 CIL, 2.0 L	2002-1996		2
TCK260M	VOLKSWAGEN	DERBY	4 CIL, 1.8 L	2008-2005		2
TCK260M	VOLKSWAGEN	GOLF	4 CIL, 2.0 L	1996-1995		2
TCK260M	VOLKSWAGEN	GOLF	4 CIL, 2.0 L	1999-1999		2
TCK260M	VOLKSWAGEN	GOLF	4 CIL, 2.0 L	2000-2000		2
TCK260M	VOLKSWAGEN	GOLF	4 CIL, 2.0 L	1998-1997		2
TCK260M	VOLKSWAGEN	JETTA	4 CIL, 2.0 L	1996-1995		2
TCK260M	VOLKSWAGEN	JETTA	4 CIL, 2.0 L	1999-1999		2
TCK260M	VOLKSWAGEN	JETTA	4 CIL, 2.0 L	2000-2000		2
TCK260M	VOLKSWAGEN	JETTA	4 CIL, 2.0 L	1998-1997		2
TCK260M	VOLKSWAGEN	PASSAT	4 CIL, 2.0 L	1996-1995		2
TCK260M	VOLKSWAGEN	POINTER	4 CIL, 1.8 L	2008-1998		2
TCK262	VOLKSWAGEN	CABRIO	4 CIL, 2.0 L	1996-1995		2
TCK262	VOLKSWAGEN	GOLF	4 CIL, 2.0 L	1995-1997		2
TCK262	VOLKSWAGEN	GTI	4 CIL, 2.0 L	2000-1999		2
TCK262	VOLKSWAGEN	JETTA	4 CIL, 2.0 L	2000-1995		2
TCK262	VOLKSWAGEN	PASSAT	4 CIL, 2.0 L	1995-1996		2
TCK262A	VOLKSWAGEN	CABRIO	4 CIL, 2.0 L	1996-1996		2
TCK296	VOLKSWAGEN	BEETLE	4 CIL, 2.0 L	1998-2000	Nvo. estilo; C/Banda doble cara	2
TCK296	VOLKSWAGEN	GOLF	4 CIL, 2.0 L	1999-2003		2
TCK296	VOLKSWAGEN	JETTA	4 CIL, 2.0 L	1999-2008		2
TCK739M	VOLKSWAGEN	EUROVAN	5 CIL, 2.5 L	2002-2000		2
TCK333M	VOLKSWAGEN	BORA	4 CIL, 1.9 L DIESEL	2007-2007		3

GATES: LA MARCA DE MÁS PRESTIGIO EN BANDAS, MANGUERAS, HIDRÁULICA Y NEUMÁTICA



## Productos Gates \* Características y especificaciones

Kit	Marca	Vehículo	Motor	Años	Observaciones	Componentes
TCK333M	VOLKSWAGEN	EUROVAN	4 CIL, 1.9 L	2008-2007		3
TCK333M	VOLKSWAGEN	EUROVAN	4 CIL, 1.9 L DIESEL	2008-2005		3
TCK333M	VOLKSWAGEN	EUROVAN	4 CIL, 1.9 L DIESEL	2006-2006		3
TCK333M	VOLKSWAGEN	JETTA	4 CIL, 1.9 L DIESEL	2007-2005		3
TCK333M	VOLKSWAGEN	BORA	4 CIL, 1.9 L DIESEL	2007-2007		3
TCK333M	VOLKSWAGEN	EUROVAN	4 CIL, 1.9 L	2008-2007		3
TCK333M	VOLKSWAGEN	EUROVAN	4 CIL, 1.9 L DIESEL	2007-2006		3
TCK333M	VOLKSWAGEN	EUROVAN	4 CIL, 1.9 L DIESEL	2008-2008		3
TCK333M	VOLKSWAGEN	EUROVAN	4 CIL, 1.9 L DIESEL	2005-2005		3
TCK333M	VOLKSWAGEN	JETTA	4 CIL, 1.9 L DIESEL	2005-2005		3
TCK333M	VOLKSWAGEN	JETTA	4 CIL, 1.9 L DIESEL	2007-2006		3
TCK321	VOLKSWAGEN	JETTA	4 CIL, 1.9 L DIESEL	2001-2003		5

GATES: LA MARCA DE MÁS PRESTIGIO EN BANDAS, MANGUERAS, HIDRÁULICA Y NEUMÁTICA



<b>ACURA</b>				<b>TT</b>				
CL				POLEA	V-8, 4.2 L	2002	- 2003	38093
POLEA	V-6, 3.0 L	1998	- 1999	38001				
POLEA	V-6, 3.2 L	2001	- 2003	38001				
TENSOR PARA BANDA MICRO-V	V-6, 3.0 L	1998	- 1999	38169				
TENSOR PARA BANDA MICRO-V	V-6, 3.2 L	2001	- 2003	38169				
TENSOR PARA BANDA ARBOL DE LEVAS	4 CIL, 2.3 L	1998	- 1999	T41013				
TENSOR PARA BANDA ARBOL DE LEVAS	4 CIL, 2.3 L	1998	- 1999	T41014				
<b>INTEGRA</b>				<b>BMW</b>				
POLEA	4 CIL, 1.8 L	1999	- 1999	38030				
TENSOR PARA BANDA ARBOL DE LEVAS	4 CIL, 1.8 L	1999	- 2001	T41016				
<b>MDX</b>				<b>318I</b>				
POLEA	V-6, 3.5 L	2003	- 2006	36112				
POLEA	V-6, 3.7 L	2007	- 2007	36112				
POLEA DECOPLADORA	V-6, 3.5 L	2006	- 2006	37008P				
POLEA DECOPLADORA	V-6, 3.7 L	2007	- 2007	37008P				
TENSOR PARA BANDA MICRO-V	V-6, 3.5 L	2001	- 2002	38327				
TENSOR PARA BANDA MICRO-V	V-6, 3.5 L	2003	- 2006	38332				
TENSOR PARA BANDA MICRO-V	V-6, 3.7 L	2007	- 2007	38332				
<b>RL</b>				<b>318IS</b>				
POLEA	V-6, 3.5 L	2006	- 2007	36112				
POLEA DECOPLADORA	V-6, 3.5 L	2006	- 2007	37008P				
TENSOR PARA BANDA MICRO-V	V-6, 3.5 L	2006	- 2007	38332				
<b>SLX</b>				<b>318TI</b>				
POLEA	V-6, 3.5 L	1999	- 1999	38005				
POLEA	V-6, 3.5 L	1999	- 1999	38008				
TENSOR PARA BANDA MICRO-V	V-6, 3.5 L	1999	- 1999	38266				
TENSOR PARA BANDA ARBOL DE LEVAS	V-6, 3.5 L	1999	- 1999	T41028				
POLEA PARA BANDA DE TIEMPO	V-6, 3.5 L	1999	- 1999	T42115				
<b>TL</b>				<b>320I</b>				
POLEA	V-6, 3.2 L	2004	- 2007	36112				
POLEA DECOPLADORA	V-6, 3.2 L	2006	- 2007	37008P				
POLEA	V-6, 3.2 L	1999	- 2003	38001				
TENSOR PARA BANDA MICRO-V	V-6, 3.2 L	1999	- 2003	38169				
TENSOR PARA BANDA MICRO-V	V-6, 3.2 L	2004	- 2007	38332				
TENSOR PARA BANDA ARBOL DE LEVAS	5 CIL, 2.5 L	1998	- 1998	T41020				
TENSOR PARA BANDA ARBOL DE LEVAS	V-6, 3.2 L	1998	- 1998	T41021				
TENSOR PARA BANDA ARBOL DE LEVAS	V-6, 3.2 L	1999	- 2000	T41090				
TENSOR PARA BANDA DE TIEMPO	V-6, 3.2 L	1999	- 2000	T42038				
<b>TSX</b>				<b>323CI</b>				
TENSOR PARA BANDA MICRO-V	4 CIL, 2.4 L	2004	- 2006	38278				
<b>AUDI</b>				<b>323SI</b>				
<b>A3</b>				<b>323IS</b>				
POLEA	4 CIL, 2.0 L	2006	- 2007	38018				
<b>A4</b>				<b>325CI</b>				
POLEA	V-6, 3.2 L	2005	- 2007	38015				
POLEA	4 CIL, 1.8 L	1998	- 2001	38068				
TENSOR PARA BANDA MICRO-V	4 CIL, 1.8 L	2000	- 2002	38151				
TENSOR PARA BANDA MICRO-V	4 CIL, 1.8 L	1998	- 1999	38151				
TENSOR PARA BANDA MICRO-V	V-6, 2.8 L	1998	- 2001	38193				
TENSOR PARA BANDA MICRO-V	4 CIL, 1.8 L	2003	- 2006	38207				
TENSOR PARA BANDA MICRO-V	4 CIL, 2.0 L	2005	- 2007	38207				
<b>A4 QUATTRO</b>				<b>325SI</b>				
TENSOR PARA BANDA MICRO-V	4 CIL, 1.8 L	2000	- 2001	38151				
TENSOR PARA BANDA MICRO-V	4 CIL, 1.8 L	1998	- 1999	38151				
<b>A6</b>				<b>328CI</b>				
POLEA	V-6, 3.0 L	2005	- 2006	38015				
POLEA	V-6, 3.2 L	2005	- 2007	38015				
POLEA	V-8, 4.2 L	2000	- 2004	38093				
TENSOR PARA BANDA MICRO-V	V-6, 2.7 L	2000	- 2004	38193				
TENSOR PARA BANDA MICRO-V	V-6, 2.8 L	1998	- 2001	38193				
<b>A6 QUATTRO</b>				<b>325XI</b>				
POLEA TENSORA	V-6, 3.2 L	2005	- 2006	38015				
TENSOR PARA BANDA MICRO-V	V-6, 2.7 L	2000	- 2000	38193				
TENSOR PARA BANDA MICRO-V	V-6, 2.8 L	1998	- 2002	38193				
<b>A8</b>				<b>328I</b>				
POLEA LOCA	V-8, 3.7 L	1998	- 1999	38093				
POLEA	V-8, 4.2 L	1998	- 1999	38093				
POLEA LOCA	V-8, 4.2 L	2000	- 2006	38093				
<b>A8 QUATTRO</b>				<b>328IS</b>				
POLEA LOCA	V-8, 4.2 L	1999	- 2000	38093				
<b>ALLROAD QUATTRO</b>				<b>328CI</b>				
POLEA	V-8, 4.2 L	2004	- 2004	38093				
TENSOR PARA BANDA MICRO-V	V-6, 2.7 L	2001	- 2006	38193				
<b>CABRIOLET</b>				<b>328I</b>				
POLEA	V-6, 2.8 L	1998	- 1998	38078				
TENSOR PARA BANDA MICRO-V	V-6, 2.8 L	1998	- 1998	38193				
<b>O7</b>				<b>328IS</b>				
TENSOR PARA BANDA MICRO-V	V-6, 3.6 L	2007	- 2007	38317				
<b>RS 6</b>				<b>328IS</b>				
POLEA	V-8, 4.2 L	2003	- 2004	38093				
<b>S4</b>				<b>328IS</b>				
TENSOR PARA BANDA MICRO-V	V-6, 2.7 L	2000	- 2002	38193				
<b>S4 QUATTRO</b>				<b>328IS</b>				
TENSOR PARA BANDA MICRO-V	V-6, 2.7 L	2000	- 2002	38193				
<b>S6</b>				<b>328IS</b>				
POLEA	V-8, 4.2 L	2002	- 2003	38093				
<b>S8</b>				<b>328IS</b>				
POLEA	V-8, 4.2 L	2002	- 2003	38093				













TENSOR PARA BANDA MICRO-V 4 CIL, 1.8 L 2007 -- 2005 TMV-14001	POLEA LOCA - LISA V-8, 8.1 L 2001 -- 2002 38001
TENSOR PARA BANDA ARBOL DE LEVAS 4 CIL, 1.8 L 2005 -- 2007 TPG-14004	POLEA DEL TENSOR V-8, 6.6 L 2001 -- 2001 38006
<b>MONTE CARLO</b>	POLEA DEL TENSOR V-6, 4.3 L 1999 -- 2001 38008
POLEA V-6, 3.4 L 2004 -- 2005 38001	POLEA LOCA V-6, 4.3 L 2001 -- 2001 38008
POLEA V-6, 3.8 L 2004 -- 2004 38006	POLEA V-8, 6.6 L 2003 -- 2007 38008
POLEA TENSORA V-6, 3.8 L 2005 -- 2005 38006	POLEA DEL TENSOR V-8, 6.6 L 2002 -- 2002 38008
TENSOR PARA BANDA MICRO-V V-6, 3.4 L 2004 -- 2005 38105	POLEA LOCA V-8, 6.6 L 2001 -- 2001 38008
<b>MONZA</b>	POLEA V-8, 4.8 L 2003 -- 2007 38009
TENSOR PARA BANDA MICRO-V 4 CIL, 1.6 L 1994 -- 2004 38200	POLEA DEL TENSOR V-8, 4.8 L 2001 -- 2002 38009
POLEA LOCA 4 CIL, 1.6 L 1994 -- 2004 T36038	POLEA V-8, 5.3 L 2003 -- 2007 38009
TENSOR PARA BANDA ARBOL DE LEVAS 4 CIL, 1.6 L 1994 -- 2004 TPG-14003	POLEA DEL TENSOR V-8, 5.3 L 2000 -- 2002 38009
<b>OPTRA</b>	POLEA V-8, 6.0 L 2003 -- 2007 38009
POLEA 4 CIL, 2.0 L 2006 -- 2008 36152	POLEA LOCA V-8, 6.0 L 2000 -- 2002 38009
TENSOR PARA BANDA MICRO-V 4 CIL, 2.0 L 2004 -- 2008 38200	POLEA DEL TENSOR V-8, 6.0 L 2003 -- 2007 38009
<b>P SERIES VAN</b>	TENSOR PARA BANDA MICRO-V V-8, 6.0 L 2000 -- 2002 38009
POLEA V-6, 4.3 L 1996 -- 1999 38001	POLEA V-8, 8.1 L 2003 -- 2007 38009
POLEA V-8, 5.7 L 1996 -- 1999 38001	POLEA DEL TENSOR V-8, 8.1 L 2001 -- 2002 38009
POLEA V-8, 7.4 L 1996 -- 1999 38001	TENSOR PARA BANDA MICRO-V V-6, 4.3 L 1999 -- 2007 38103
POLEA V-6, 4.3 L 1996 -- 1999 38008	TENSOR PARA BANDA MICRO-V V-8, 6.6 L 2001 -- 2001 38136
POLEA V-6, 4.3 L 1996 -- 1999 38008	TENSOR PARA BANDA MICRO-V V-8, 4.8 L 2001 -- 2007 38158
POLEA V-8, 5.7 L 1996 -- 1999 38008	TENSOR PARA BANDA MICRO-V V-8, 5.3 L 2000 -- 2007 38158
POLEA V-8, 5.7 L 1996 -- 1999 38008	TENSOR PARA BANDA MICRO-V V-8, 4.8 L 2001 -- 2007 38159
POLEA V-8, 7.4 L 1998 -- 1999 38008	TENSOR PARA BANDA MICRO-V V-8, 5.3 L 2000 -- 2007 38159
POLEA V-8, 7.4 L 1996 -- 1999 38008	TENSOR PARA BANDA MICRO-V V-8, 6.0 L 2000 -- 2007 38159
POLEA V-6, 4.3 L 1992 -- 1995 38037	<b>SILVERADO 2500</b>
POLEA V-8, 5.7 L 1989 -- 1990 38037	POLEA LOCA V-8, 5.3 L 1999 -- 1999 38001
POLEA V-8, 5.7 L 1991 -- 1996 38037	POLEA V-8, 5.3 L 1999 -- 1999 38009
TENSOR PARA BANDA MICRO-V V-6, 4.3 L 1996 -- 1999 38103	TENSOR PARA BANDA MICRO-V V-8, 5.3 L 1999 -- 1999 38158
TENSOR PARA BANDA MICRO-V V-8, 5.7 L 1996 -- 1999 38103	TENSOR PARA BANDA MICRO-V V-8, 5.3 L 1999 -- 2002 38159
TENSOR PARA BANDA MICRO-V V-8, 7.4 L 1998 -- 1999 38103	<b>SILVERADO 2500 4X4</b>
TENSOR PARA BANDA MICRO-V V-8, 7.4 L 1996 -- 1997 38103	POLEA LOCA V-8, 5.3 L 1999 -- 2002 38001
<b>P31 VANETTE</b>	POLEA LOCA V-8, 6.0 L 1999 -- 1999 38001
POLEA LOCA V-8, 5.7 L 1996 -- 1999 38001	POLEA DEL TENSOR V-8, 6.5 L 1999 -- 1999 38006
POLEA DEL TENSOR V-8, 5.7 L 1996 -- 1999 38008	POLEA DEL TENSOR V-8, 5.3 L 1999 -- 2002 38009
TENSOR PARA BANDA MICRO-V V-8, 5.7 L 1996 -- 1999 38103	POLEA DEL TENSOR V-8, 6.0 L 1999 -- 1999 38009
<b>PICKUP 1500</b>	TENSOR PARA BANDA MICRO-V V-8, 6.0 L 1999 -- 1999 38118
POLEA LOCA V-6, 4.3 L 2003 -- 2003 38001	TENSOR PARA BANDA MICRO-V V-8, 5.3 L 1999 -- 2002 38158
POLEA LOCA V-6, 4.3 L 2003 -- 2003 38008	TENSOR PARA BANDA MICRO-V V-8, 6.0 L 1999 -- 1999 38158
TENSOR PARA BANDA MICRO-V V-6, 4.3 L 2003 -- 2003 38103	TENSOR PARA BANDA MICRO-V V-8, 5.3 L 1999 -- 2002 38159
<b>REGAL</b>	TENSOR PARA BANDA MICRO-V V-8, 6.0 L 1999 -- 1999 38159
POLEA V-6, 3.8 L 1996 -- 1996 38015	<b>SILVERADO 3500 HD</b>
POLEA LOCA V-6, 3.8 L 1994 -- 1995 38027	POLEA LOCA V-8, 8.1 L 2002 -- 2002 38001
TENSOR PARA BANDA MICRO-V V-6, 3.8 L 1994 -- 1995 38126	POLEA DEL TENSOR V-8, 8.1 L 2002 -- 2002 38009
TENSOR PARA BANDA MICRO-V V-6, 3.8 L 1996 -- 1996 38152	<b>SILVERADO PICKUP</b>
<b>S SERIES PICKUP</b>	POLEA V-6, 4.3 L 1999 -- 2007 38001
POLEA 4 CIL, 2.2 L 1994 -- 1997 38001	POLEA V-8, 4.8 L 1999 -- 2007 38001
POLEA 4 CIL, 2.5 L 1989 -- 1993 38001	POLEA V-8, 5.3 L 1999 -- 2007 38001
POLEA V-6, 2.8 L 1989 -- 1993 38001	POLEA V-8, 6.0 L 1999 -- 2007 38001
POLEA V-6, 4.3 L 1991 -- 2004 38001	POLEA V-8, 8.1 L 2001 -- 2007 38001
POLEA V-6, 4.3 L 1989 -- 1990 38001	POLEA V-6, 4.3 L 1999 -- 2007 38008
POLEA V-6, 4.3 L 1989 -- 1995 38006	POLEA DEL TENSOR V-6, 4.3 L 2004 -- 2004 38008
POLEA V-6, 4.3 L 1989 -- 1995 38006	POLEA V-8, 4.8 L 1999 -- 2007 38009
POLEA LOCA - LISA 4 CIL, 2.2 L 1998 -- 2001 38015	POLEA V-8, 5.3 L 1999 -- 2007 38009
POLEA LOCA 4 CIL, 2.2 L 2002 -- 2003 38015	POLEA V-8, 6.0 L 1999 -- 2007 38009
POLEA V-6, 2.8 L 1989 -- 1993 38020	TENSOR PARA BANDA MICRO-V V-6, 4.3 L 1999 -- 2007 38103
POLEA V-6, 4.3 L 1989 -- 1995 38024	TENSOR PARA BANDA MICRO-V V-8, 4.8 L 1999 -- 2007 38158
POLEA 4 CIL, 2.5 L 1989 -- 1989 38034	TENSOR PARA BANDA MICRO-V V-8, 5.3 L 1999 -- 2007 38158
TENSOR PARA BANDA MICRO-V V-6, 4.3 L 1996 -- 2004 38103	TENSOR PARA BANDA MICRO-V V-8, 4.8 L 1999 -- 2007 38159
TENSOR PARA BANDA MICRO-V V-6, 4.3 L 1991 -- 1995 38108	TENSOR PARA BANDA MICRO-V V-8, 5.3 L 1999 -- 2007 38159
TENSOR PARA BANDA MICRO-V V-6, 4.3 L 1989 -- 1990 38108	TENSOR PARA BANDA MICRO-V V-8, 6.0 L 1999 -- 2007 38159
TENSOR PARA BANDA MICRO-V V-6, 2.8 L 1989 -- 1993 38130	TENSOR PARA BANDA MICRO-V V-8, 8.1 L 2001 -- 2007 38259
TENSOR PARA BANDA MICRO-V 4 CIL, 2.5 L 1989 -- 1993 38144	TENSOR PARA BANDA MICRO-V V-8, 8.1 L 2001 -- 2007 38260
TENSOR PARA BANDA MICRO-V 4 CIL, 2.2 L 1998 -- 2003 38165	<b>SILVERADO PICKUP 1500</b>
TENSOR PARA BANDA MICRO-V 4 CIL, 2.2 L 1994 -- 1997 38187	POLEA LOCA V-6, 4.3 L 2003 -- 2003 38001
<b>S-10</b>	POLEA LOCA V-6, 4.3 L 2003 -- 2003 38008
POLEA DEL TENSOR 4 CIL, 2.2 L 1995 -- 1997 38001	TENSOR PARA BANDA MICRO-V V-6, 4.3 L 2003 -- 2003 38103
POLEA TENSORA 4 CIL, 2.2 L 1994 -- 1994 38001	<b>SSR</b>
POLEA DEL TENSOR V-6, 4.3 L 1995 -- 1995 38001	POLEA V-8, 5.3 L 2003 -- 2004 38001
POLEA LOCA V-6, 4.3 L 1996 -- 2001 38001	POLEA V-8, 6.0 L 2005 -- 2006 38001
POLEA LOCA - LISA V-6, 4.3 L 2002 -- 2002 38001	POLEA V-8, 5.3 L 2003 -- 2004 38009
POLEA TENSORA V-6, 4.3 L 1992 -- 1994 38001	POLEA V-8, 6.0 L 2005 -- 2006 38009
POLEA V-6, 4.3 L 1994 -- 1994 38006	TENSOR PARA BANDA MICRO-V V-8, 5.3 L 2003 -- 2004 38158
POLEA LOCA V-6, 4.3 L 1995 -- 1995 38006	TENSOR PARA BANDA MICRO-V V-8, 6.0 L 2005 -- 2006 38158
POLEA DEL TENSOR V-6, 4.3 L 1996 -- 2001 38008	TENSOR PARA BANDA MICRO-V V-8, 5.3 L 2003 -- 2004 38159
POLEA DEL TENSOR 4 CIL, 2.2 L 1998 -- 2002 38015	TENSOR PARA BANDA MICRO-V V-8, 6.0 L 2005 -- 2006 38159
POLEA LOCA 4 CIL, 2.2 L 2003 -- 2003 38015	<b>SUBURBAN</b>
POLEA V-6, 4.3 L 1994 -- 1994 38024	POLEA V-8, 5.3 L 2000 -- 2007 38001
POLEA LOCA V-6, 4.3 L 1995 -- 1995 38024	POLEA LOCA V-8, 5.3 L 2003 -- 2004 38001
TENSOR PARA BANDA MICRO-V V-6, 4.3 L 1996 -- 2002 38103	POLEA V-8, 5.7 L 1989 -- 1991 38001
TENSOR PARA BANDA MICRO-V V-6, 4.3 L 1992 -- 1995 38108	POLEA DEL TENSOR V-8, 5.7 L 1992 -- 1995 38001
TENSOR PARA BANDA MICRO-V 4 CIL, 2.2 L 1998 -- 2002 38165	POLEA LOCA V-8, 5.7 L 1996 -- 1999 38001
TENSOR PARA BANDA MICRO-V 4 CIL, 2.2 L 1994 -- 1997 38187	POLEA V-8, 6.0 L 2000 -- 2007 38001
<b>SILVERADO</b>	POLEA V-8, 7.4 L 1992 -- 1999 38001
POLEA LOCA V-6, 4.3 L 2000 -- 2001 38001	POLEA V-8, 7.4 L 1989 -- 1991 38001
POLEA LOCA V-6, 4.3 L 2000 -- 2001 38008	POLEA V-8, 8.1 L 2001 -- 2006 38001
TENSOR PARA BANDA MICRO-V V-6, 4.3 L 2000 -- 2001 38103	POLEA V-8, 5.7 L 1989 -- 1991 38006
<b>SILVERADO 1500</b>	POLEA LOCA V-8, 5.7 L 1992 -- 1995 38006
POLEA LOCA V-6, 4.3 L 2003 -- 2007 38001	POLEA DEL TENSOR V-8, 5.7 L 1996 -- 1999 38008
POLEA LOCA V-6, 4.3 L 1999 -- 2000 38001	POLEA V-8, 7.4 L 1996 -- 1999 38008
POLEA LOCA - LISA V-6, 4.3 L 2001 -- 2002 38001	POLEA V-8, 5.3 L 2000 -- 2007 38009
POLEA LOCA V-8, 4.8 L 2001 -- 2007 38001	POLEA DEL TENSOR V-8, 5.3 L 2003 -- 2004 38009
POLEA LOCA V-8, 5.3 L 2000 -- 2007 38001	POLEA V-8, 6.0 L 2000 -- 2007 38009
POLEA LOCA V-8, 6.0 L 2000 -- 2007 38001	POLEA V-8, 7.4 L 1994 -- 1995 38009
POLEA LOCA V-8, 8.1 L 2000 -- 2007 38001	POLEA V-8, 8.1 L 2001 -- 2006 38009
POLEA LOCA V-8, 8.1 L 2003 -- 2007 38001	POLEA DEL TENSOR V-8, 8.1 L 2002 -- 2002 38009
	POLEA V-8, 7.4 L 1994 -- 1995 38019











Modelo	Motor	Año	Parte	Código	Modelo	Motor	Año	Parte	Código		
<b>RAM WAGON 2500</b>					<b>CONTOUR</b>						
TENSOR PARA BANDA MICRO-V	V-8, 5.2 L	1997	-	2001	38116	POLEA	V-8, 5.8 L	1994	-	1996	38007
POLEA DEL TENSOR	V-8, 5.2 L	1997	-	2001	38016	POLEA LOCA	V-8, 5.0 L	1994	-	1996	38015
POLEA DEL TENSOR	V-8, 5.9 L	1994	-	1995	38016	POLEA	V-8, 5.8 L	1995	-	1996	38038
TENSOR PARA BANDA MICRO-V	V-8, 5.2 L	1997	-	2001	38116	TENSOR PARA BANDA MICRO-V	V-8, 5.0 L	1994	-	1996	38123
TENSOR PARA BANDA MICRO-V	V-8, 5.9 L	1994	-	1995	38116	TENSOR PARA BANDA MICRO-V	V-8, 5.8 L	1994	-	1996	38123
<b>RAM WAGON 3500</b>					<b>COUGAR</b>						
POLEA DEL TENSOR	V-8, 5.9 L	2002	-	2002	38016	POLEA	4 CIL, 2.0 L	1995	-	1997	38001
TENSOR PARA BANDA MICRO-V	V-8, 5.9 L	2002	-	2002	38116	POLEA LOCA	V-6, 2.5 L	1996	-	2000	38001
<b>RAM WAGON 3500 SLT</b>					<b>CROWN VICTORIA</b>						
TENSOR PARA BANDA MICRO-V	V-8, 5.9 L	2000	-	2000	38116	POLEA	V-6, 2.5 L	2002	-	2002	38018
TENSOR PARA BANDA MICRO-V	V-8, 5.9 L	2000	-	2000	38180	<b>E SERIES VAN</b>					
<b>SHADOW</b>					<b>FIAT</b>						
POLEA	4 CIL, 2.2 L	1994	-	1994	38003	<b>DUCATO</b>					
POLEA LOCA	4 CIL, 2.2 L	1989	-	1990	38003	TENSOR PARA BANDA ARBOL DE LEVAS	4 CIL, 2.3 L	2008	-	2008	T43163
POLEA	4 CIL, 2.5 L	1994	-	1994	38003	<b>PALIO</b>					
POLEA LOCA	4 CIL, 2.5 L	1995	-	1995	38003	POLEA LOCA DISTRIBUCION	4 CIL, 1.6 L	2003	-	2006	T42061
POLEA LOCA	4 CIL, 2.5 L	1989	-	1993	38003	TENSOR PARA BANDA ARBOL DE LEVAS	4 CIL, 1.6 L	2003	-	2006	T43068
POLEA LOCA	4 CIL, 2.2 L	1989	-	1989	38004	TENSOR PARA BANDA MICRO-V	4 CIL, 1.8 L	2006	-	2008	TMV-14001
POLEA LOCA	4 CIL, 2.5 L	1989	-	1989	38004	TENSOR PARA BANDA ARBOL DE LEVAS	4 CIL, 1.8 L	2006	-	2008	TPG-14004
TENSOR PARA BANDA ARBOL DE LEVAS	4 CIL, 2.2 L	1994	-	1994	T41001	<b>PALIO ADVENTURE</b>					
TENSOR PARA BANDA ARBOL DE LEVAS	4 CIL, 2.5 L	1994	-	1994	T41001	POLEA LOCA DISTRIBUCION	4 CIL, 1.6 L	2003	-	2006	T42061
<b>SPRINTER</b>					<b>FORD</b>						
POLEA LOCA	4 CIL, 2.5 L	1990	-	1995	38003	<b>AEROSTAR</b>					
POLEA	V-6, 3.0 L	1994	-	1995	38003	POLEA LOCA	V-6, 4.0 L	1996	-	1997	38001
POLEA	V-6, 3.0 L	1994	-	1995	38042	POLEA	V-6, 3.0 L	1994	-	1997	38002
TENSOR PARA BANDA MICRO-V	V-6, 3.0 L	1994	-	1995	38122	POLEA LOCA	V-6, 4.0 L	1990	-	1995	38002
TENSOR PARA BANDA ARBOL DE LEVAS	4 CIL, 2.5 L	1994	-	1995	T41001	POLEA DEL TENSOR	V-6, 3.0 L	1995	-	1997	38006
TENSOR PARA BANDA ARBOL DE LEVAS	V-6, 3.0 L	1994	-	1995	T41048	POLEA DEL TENSOR	V-6, 4.0 L	1996	-	1997	38008
<b>STRATUS</b>					<b>BRONCO</b>						
POLEA LOCA	4 CIL, 2.0 L	1996	-	2000	38020	POLEA	V-8, 5.0 L	1994	-	1996	38006
POLEA LOCA	4 CIL, 2.4 L	1995	-	2000	38020	POLEA	V-8, 5.8 L	1994	-	1996	38006
POLEA LOCA	V-6, 2.5 L	1999	-	2000	38020	POLEA	V-8, 5.0 L	1994	-	1996	38007
POLEA	4 CIL, 2.0 L	1996	-	2000	38042						
POLEA LOCA	4 CIL, 2.0 L	1995	-	1995	38042						
POLEA	4 CIL, 2.4 L	1995	-	2000	38042						
POLEA	V-6, 2.5 L	1995	-	2000	38042						
TENSOR PARA BANDA ARBOL DE LEVAS	4 CIL, 2.0 L	1995	-	1995	T41002						
TENSOR PARA BANDA ARBOL DE LEVAS	4 CIL, 2.0 L	1996	-	2000	T41002						
TENSOR PARA BANDA ARBOL DE LEVAS	4 CIL, 2.4 L	2001	-	2004	T41038						
TENSOR PARA BANDA ARBOL DE LEVAS	V-6, 2.5 L	1995	-	2000	T41039						
TENSOR PARA BANDA ARBOL DE LEVAS	V-6, 3.0 L	2001	-	2004	T41039						
TENSOR PARA BANDA ARBOL DE LEVAS	4 CIL, 2.4 L	2001	-	2004	T41054						
TENSOR PARA BANDA TIEMPO	4 CIL, 2.4 L	2001	-	2004	T42017						
TENSOR PARA BANDA TIEMPO	V-6, 2.5 L	1995	-	2000	T42018						
TENSOR PARA BANDA TIEMPO	V-6, 3.0 L	2001	-	2004	T42018						
TENSOR PARA BANDA TIEMPO	4 CIL, 2.4 L	1995	-	2000	T42121						
TENSOR PARA BANDA TIEMPO	4 CIL, 2.4 L	2001	-	2003	T42121						
TENSOR PARA BANDA TIEMPO	4 CIL, 2.4 L	2004	-	2006	T42121						
TENSOR PARA BANDA ARBOL DE LEVAS	4 CIL, 2.0 L	1996	-	2000	T43001						
TENSOR PARA BANDA ARBOL DE LEVAS	4 CIL, 2.4 L	2001	-	2002	T43005						
TENSOR PARA BANDA ARBOL DE LEVAS	4 CIL, 2.4 L	1997	-	2000	T43005						
TENSOR PARA BANDA ARBOL DE LEVAS	4 CIL, 2.4 L	1996	-	1996	T43005						
TENSOR PARA BANDA ARBOL DE LEVAS	4 CIL, 2.4 L	2005	-	2006	T43008						
TENSOR PARA BANDA ARBOL DE LEVAS	4 CIL, 2.4 L	2003	-	2003	T43008						
TENSOR PARA BANDA ARBOL DE LEVAS	4 CIL, 2.4 L	2001	-	2002	T43008						
TENSOR PARA BANDA ARBOL DE LEVAS	4 CIL, 2.4 L	2004	-	2004	T43008						
TENSOR PARA BANDA ARBOL DE LEVAS	4 CIL, 2.4 L	1997	-	2000	T43008						
<b>VIPER</b>											
POLEA	V-10, 8.0 L	1995	-	2002	38033						
TENSOR PARA BANDA MICRO-V	V-10, 8.0 L	1998	-	2002	38350						





Table listing various automotive components like Poles (POLEA), Tensors (TENSOR PARA BANDA MICRO-V), and Kits (F-250 LOBO, F-350 SUPER DUTY, etc.) with columns for part name, specifications, and prices across different years.









POLEA	TENSOR PARA BANDA MICRO-V	V-8, 5.5 L	2002	-	2005	38082
<b>E320</b>	POLEA DEL TENSOR	V-8, 5.5 L	2001	-	2006	38174
<b>E430</b>	POLEA DEL TENSOR	V-6, 3.2 L	2001	-	2006	38082
<b>E500</b>	POLEA DEL TENSOR	V-8, 4.3 L	2001	-	2002	38082
<b>E55</b>	POLEA DEL TENSOR	V-8, 5.0 L	2003	-	2005	38082
<b>G500</b>	POLEA DEL TENSOR	V-8, 5.5 L	2001	-	2002	38082
<b>G55</b>	POLEA DEL TENSOR	V-8, 5.5 L	2003	-	2005	38082
<b>ML320</b>	POLEA DEL TENSOR	V-6, 3.2 L	2001	-	2003	38082
<b>ML350</b>	POLEA DEL TENSOR	V-6, 3.2 L	2001	-	2003	38174
<b>ML430</b>	POLEA DEL TENSOR	V-6, 3.7 L	2003	-	2005	38082
<b>ML500</b>	POLEA DEL TENSOR	V-8, 4.3 L	2001	-	2001	38082
<b>ML55</b>	POLEA DEL TENSOR	V-8, 5.0 L	2002	-	2005	38082
<b>S430</b>	POLEA DEL TENSOR	V-8, 5.5 L	2001	-	2003	38082
<b>S500</b>	POLEA DEL TENSOR	V-8, 4.3 L	2001	-	2005	38082
<b>S55</b>	POLEA DEL TENSOR	V-8, 5.0 L	2001	-	2005	38082
<b>SL500</b>	POLEA DEL TENSOR	V-8, 5.0 L	2001	-	2005	38082
<b>SL55</b>	POLEA DEL TENSOR	V-8, 5.0 L	2001	-	2005	38174
<b>SL600</b>	POLEA DEL TENSOR	V-8, 5.5 L	2003	-	2006	38174
<b>SLK230</b>	POLEA DEL TENSOR	V-12, 6.0 L	2001	-	2001	38090
<b>SLK320</b>	POLEA DEL TENSOR	4 CIL, 2.3 L	2001	-	2004	38225
<b>SLK350</b>	POLEA DEL TENSOR	V-6, 3.2 L	2001	-	2004	38082
<b>SPRINTER</b>	POLEA DEL TENSOR	V-6, 3.5 L	2005	-	2005	38082
<b>MERCURY</b>						
<b>COUGAR</b>						
POLEA	POLEA DEL TENSOR	V-6, 3.8 L	1995	-	1997	38001
POLEA DEL TENSOR	POLEA	V-8, 5.0 L	1991	-	1991	38001
POLEA	POLEA DEL TENSOR	V-6, 3.8 L	1988	-	1988	38006
POLEA DEL TENSOR	POLEA	V-8, 4.6 L	1996	-	1997	38006
POLEA LOCA	POLEA DEL TENSOR	V-8, 4.6 L	1995	-	1995	38006
POLEA LOCA	POLEA	V-8, 4.6 L	1994	-	1994	38006
POLEA LOCA	POLEA DEL TENSOR	V-6, 3.8 L	1991	-	1991	38007
POLEA	POLEA DEL TENSOR	V-6, 3.8 L	1991	-	1997	38009
TENSOR PARA BANDA MICRO-V	POLEA DEL TENSOR	V-6, 3.8 L	1989	-	1997	38127
TENSOR PARA BANDA MICRO-V	POLEA	V-8, 4.6 L	1994	-	1997	38132
TENSOR PARA BANDA MICRO-V	POLEA	V-8, 5.0 L	1991	-	1992	38249
TENSOR PARA BANDA MICRO-V	POLEA	V-6, 3.8 L	1990	-	1990	38297
<b>COUGAR LS</b>						
TENSOR PARA BANDA MICRO-V	POLEA	V-6, 3.8 L	1990	-	1990	38127
TENSOR PARA BANDA MICRO-V	POLEA	V-6, 3.8 L	1990	-	1990	38297
<b>COUGAR XR7</b>						
POLEA LOCA	POLEA	V-6, 3.8 L	1993	-	1994	38007
POLEA	POLEA	V-6, 3.8 L	1993	-	1994	38009

TENSOR PARA BANDA MICRO-V	V-6, 3.8 L	1991	-	1994	38127
<b>GRAND MAROUIS</b>					
POLEA	V-8, 4.6 L	2003	-	2006	36100
POLEA DEL TENSOR	V-8, 4.2 L	1982	-	1982	38006
POLEA	V-8, 4.6 L	2006	-	2006	38006
POLEA DEL TENSOR	V-8, 4.6 L	1992	-	1992	38006
POLEA LOCA	V-8, 4.6 L	1993	-	1999	38006
POLEA TENSORA	V-8, 4.6 L	2005	-	2005	38006
POLEA DEL TENSOR	V-8, 5.0 L	1982	-	1984	38006
TENSOR PARA BANDA MICRO-V	V-8, 4.2 L	1982	-	1982	38121
TENSOR PARA BANDA MICRO-V	V-8, 5.0 L	1983	-	1984	38121
TENSOR PARA BANDA MICRO-V	V-8, 4.6 L	1992	-	1999	38132
TENSOR PARA BANDA MICRO-V	V-8, 4.6 L	2000	-	2006	38189
<b>MARINER</b>					
POLEA	V-6, 3.0 L	2005	-	2005	38008
TENSOR PARA BANDA MICRO-V	V-6, 3.0 L	2005	-	2007	38279
TENSOR PARA BANDA MICRO-V	4 CIL, 2.3 L	2005	-	2007	38408
<b>MILAN</b>					
POLEA	V-6, 3.0 L	2006	-	2007	38006
POLEA	V-6, 3.0 L	2006	-	2007	38008
TENSOR PARA BANDA MICRO-V	V-6, 3.0 L	2006	-	2007	38279
<b>MONTEGO</b>					
TENSOR PARA BANDA MICRO-V	V-6, 3.0 L	2005	-	2006	38279
<b>MOUNTAINEER</b>					
POLEA	V-6, 4.0 L	1998	-	2005	38001
POLEA	V-8, 4.6 L	2003	-	2005	38001
POLEA	V-8, 5.0 L	1997	-	2001	38001
POLEA	V-8, 5.0 L	1997	-	2001	38002
POLEA	V-8, 4.6 L	2003	-	2005	38006
POLEA	V-8, 5.0 L	1998	-	2001	38006
POLEA	V-6, 4.0 L	1998	-	2003	38008
TENSOR PARA BANDA MICRO-V	V-6, 4.0 L	1998	-	1999	38102
TENSOR PARA BANDA MICRO-V	V-6, 4.0 L	2000	-	2005	38137
TENSOR PARA BANDA MICRO-V	V-8, 5.0 L	1997	-	2000	38161
TENSOR PARA BANDA MICRO-V	V-8, 4.6 L	2002	-	2005	38274
<b>MYSTIQUE</b>					
POLEA	4 CIL, 2.0 L	1995	-	1997	38001
POLEA LOCA	V-6, 2.5 L	1995	-	2000	38001
POLEA	4 CIL, 2.0 L	1998	-	1998	38006
POLEA DEL TENSOR	V-6, 2.5 L	1995	-	2000	38006
POLEA	4 CIL, 2.0 L	1998	-	2000	38008
POLEA	4 CIL, 2.0 L	1998	-	1998	38018
POLEA LOCA	4 CIL, 2.0 L	1999	-	2000	38018
TENSOR PARA BANDA MICRO-V	4 CIL, 2.0 L	1995	-	1997	38160
TENSOR PARA BANDA MICRO-V	4 CIL, 2.0 L	1998	-	2000	38188
TENSOR PARA BANDA MICRO-V	V-6, 2.5 L	1995	-	2000	38250
TENSOR PARA BANDA ARBOL DE LEVAS	4 CIL, 2.0 L	1995	-	1997	T41008
POLEA PARA BANDA DE TIEMPO	4 CIL, 2.0 L	1995	-	1997	T42032
POLEA PARA BANDA DE TIEMPO	4 CIL, 2.0 L	1995	-	1997	T42033
POLEA PARA BANDA DE TIEMPO	4 CIL, 2.0 L	1998	-	2000	T42034
POLEA PARA BANDA DE TIEMPO	4 CIL, 2.0 L	1998	-	1998	T42035
POLEA PARA BANDA DE TIEMPO	4 CIL, 2.0 L	1999	-	1999	T42035
POLEA PARA BANDA DE TIEMPO	4 CIL, 2.0 L	2000	-	2000	T42036
POLEA PARA BANDA DE TIEMPO	4 CIL, 2.0 L	1999	-	1999	T42036
TENSOR PARA BANDA ARBOL DE LEVAS	4 CIL, 2.0 L	1998	-	2000	T43003
<b>SABLE / TAURUS</b>					
POLEA LOCA	V-6, 3.0 L	1997	-	2004	38001
POLEA DEL TENSOR	V-6, 3.0 L	1996	-	2002	38006
POLEA TENSORA	V-6, 3.0 L	2003	-	2005	38006
POLEA LOCA	V-6, 3.8 L	1993	-	1994	38006
POLEA LOCA	V-6, 3.8 L	1990	-	1990	38007
POLEA	V-6, 3.8 L	1990	-	1993	38009
POLEA DEL TENSOR	V-6, 3.8 L	1994	-	1995	38009
POLEA LOCA	V-6, 3.8 L	1991	-	1995	38023
TENSOR PARA BANDA MICRO-V	V-6, 3.0 L	1996	-	2005	38114
TENSOR PARA BANDA MICRO-V	V-6, 3.8 L	1990	-	1995	38139
TENSOR PARA BANDA MICRO-V	V-6, 3.0 L	1998	-	2000	38181
TENSOR PARA BANDA MICRO-V	V-6, 3.0 L	2003	-	2005	38186
<b>MITSUBISHI</b>					
<b>DIAMANTE</b>					
TENSOR PARA BANDA ARBOL DE LEVAS	V-6, 3.5 L	2000	-	2004	T41039
POLEA PARA BANDA DE TIEMPO	V-6, 3.5 L	2000	-	2004	T42018
<b>ECLIPSE</b>					
TENSOR PARA BANDA ARBOL DE LEVAS	4 CIL, 2.4 L	2000	-	2005	T41038
TENSOR PARA BANDA ARBOL DE LEVAS	V-6, 3.0 L	2000	-	2005	T41039
TENSOR PARA BANDA ARBOL DE LEVAS	4 CIL, 2.4 L	2000	-	2005	T41054
POLEA PARA BANDA DE TIEMPO	4 CIL, 2.4 L	2000	-	2005	T42017
POLEA PARA BANDA DE TIEMPO	V-6, 3.0 L	2000	-	2005	T42018
<b>ENDEAVOR</b>					
TENSOR PARA BANDA ARBOL DE LEVAS	V-6, 3.8 L	2004	-	2007	T41039
POLEA PARA BANDA DE TIEMPO	V-6, 3.8 L	2004	-	2007	T42018
<b>GALANT</b>					
TENSOR PARA BANDA ARBOL DE LEVAS	4 CIL, 2.4 L	2000	-	2007	T41038
TENSOR PARA BANDA ARBOL DE LEVAS	V-6, 3.0 L	2000	-	2003	T41039
TENSOR PARA BANDA ARBOL DE LEVAS	V-6, 3.8 L	2004	-	2005	T41039
TENSOR PARA BANDA ARBOL DE LEVAS	4 CIL, 2.4 L	2000	-	2003	T41054
POLEA PARA BANDA DE TIEMPO	4 CIL, 2.4 L	2000	-	2003	T42017
POLEA PARA BANDA DE TIEMPO	V-6, 3.0 L	2000	-	2003	T42018
POLEA PARA BANDA DE TIEMPO	V-6, 3.8 L	2004	-	2005	T42018
<b>LANCER</b>					
TENSOR PARA BANDA ARBOL DE LEVAS	4 CIL, 2.0 L	2006	-	2006	T41038
TENSOR PARA BANDA ARBOL DE LEVAS	4 CIL, 2.0 L	2003	-	2005	T41038
TENSOR PARA BANDA ARBOL DE LEVAS	4 CIL, 2.4 L	2004	-	2005	T41038
TENSOR PARA BANDA ARBOL DE LEVAS	4 CIL, 2.0 L	2002	-	2002	T41212









<b>TENSOR PARA BANDA MICRO-V</b> V-6, 3.0 L 2000 - 2003 38179 <b>TENSOR</b> 4 CIL, 2.3 L 2002 - 2007 38226 <b>TENSOR PARA BANDA MICRO-V</b> 4 CIL, 2.3 L 2000 - 2006 38226 <b>TENSOR</b> V6, 3.0 L 2003 - 2003 38226				<b>POLEA PARA BANDA DE TIEMPO</b> 4 CIL, 2.5 l 2006 - 2006 T42024 <b>OUTBACK</b> <b>POLEA</b> 4 CIL, 2.5 l 2004 - 2006 38030 <b>POLEA PARA BANDA DE TIEMPO</b> 4 CIL, 2.5 l 2005 - 2006 T42023 <b>POLEA PARA BANDA DE TIEMPO</b> 4 CIL, 2.5 l 2005 - 2006 T42024			
<b>9-7X</b> <b>POLEA</b> 6 CIL, 4.2 L 2005 - 2007 36101 <b>POLEA</b> V-8, 5.3 L 2005 - 2007 38001 <b>POLEA</b> 6 CIL, 4.2 L 2005 - 2007 38006 <b>POLEA</b> V-8, 5.3 L 2005 - 2007 38009 <b>TENSOR PARA BANDA MICRO-V</b> V-8, 5.3 L 2005 - 2007 38158 <b>TENSOR PARA BANDA MICRO-V</b> V-8, 5.3 L 2005 - 2007 38159 <b>TENSOR PARA BANDA MICRO-V</b> 6 CIL, 4.2 L 2005 - 2007 38178				<b>SUZUKI</b> <b>AERIO</b> <b>POLEA</b> 4 CIL, 2.3 l 2004 - 2006 38010 <b>TENSOR PARA BANDA MICRO-V</b> 4 CIL, 2.3 l 2004 - 2006 38156 <b>FORENZA</b> <b>TENSOR PARA BANDA MICRO-V</b> 4 CIL, 2.0 l 2004 - 2007 38200 <b>RENO</b> <b>TENSOR PARA BANDA MICRO-V</b> 4 CIL, 2.0 l 2005 - 2007 38200 <b>SWIFT</b> <b>POLEA</b> 4 CIL, 1.6 l 2004 - 2007 38015 <b>POLEA</b> 4 CIL, 1.6 l 2006 - 2007 38024 <b>POLEA</b> 4 CIL, 1.6 l 2004 - 2005 38024 <b>SX4</b> <b>TENSOR PARA BANDA MICRO-V</b> 4 CIL, 2.0 l 2007 - 2008 38156 <b>VERONA</b> <b>POLEA</b> 6 CIL, 2.5 l 2004 - 2006 38018 <b>TENSOR PARA BANDA MICRO-V</b> 6 CIL, 2.5 l 2004 - 2006 38273 <b>VITARA</b> <b>POLEA</b> 4 CIL, 2.0 l 2004 - 2004 38010 <b>TENSOR PARA BANDA MICRO-V</b> 4 CIL, 2.0 l 2004 - 2004 38156 <b>XL-7</b> <b>TENSOR</b> V6, 3.6 L 2007 - 2008 38397			
<b>SATURN</b> <b>AURA</b> <b>POLEA</b> V-6, 3.5 L 2007 - 2007 38006 <b>POLEA</b> V-6, 3.5 L 2007 - 2007 38009 <b>ION</b> <b>POLEA</b> 4 CIL, 2.2 L 2003 - 2007 38011 <b>POLEA</b> 4 CIL, 2.4 L 2006 - 2007 38011 <b>TENSOR PARA BANDA MICRO-V</b> 4 CIL, 2.2 L 2003 - 2007 38177 <b>TENSOR PARA BANDA MICRO-V</b> 4 CIL, 2.4 L 2006 - 2007 38177 <b>L-SERIES</b> <b>POLEA</b> V-6, 3.0 L 2000 - 2005 38009 <b>POLEA</b> 4 CIL, 2.2 L 2000 - 2004 38011 <b>TENSOR PARA BANDA MICRO-V</b> 4 CIL, 2.2 L 2000 - 2004 38177 <b>TENSOR PARA BANDA MICRO-V</b> V-6, 3.0 L 2000 - 2005 38179 <b>RELAY</b> <b>POLEA</b> V-6, 3.9 L 2006 - 2007 38006 <b>POLEA</b> V-6, 3.5 L 2005 - 2006 38009 <b>POLEA</b> V-6, 3.9 L 2006 - 2007 38009 <b>POLEA</b> V-6, 3.5 L 2005 - 2006 38043 <b>TENSOR PARA BANDA MICRO-V</b> V-6, 3.5 L 2005 - 2006 38104 <b>SKY</b> <b>POLEA</b> 4 CIL, 2.4 l 2007 - 2007 38011 <b>TENSOR PARA BANDA MICRO-V</b> 4 CIL, 2.4 l 2007 - 2007 38177 <b>S-SERIES</b> <b>POLEA</b> 4 CIL, 1.9 l 1991 - 1999 38010 <b>POLEA</b> 4 CIL, 1.9 l 1991 - 2002 38026 <b>POLEA</b> 4 CIL, 1.9 l 2000 - 2002 38032 <b>TENSOR PARA BANDA MICRO-V</b> 4 CIL, 1.9 l 1991 - 2002 38112 <b>VUE</b> <b>POLEA</b> V-6, 3.5 L 2004 - 2007 38006 <b>POLEA</b> V-6, 3.0 L 2002 - 2003 38009 <b>POLEA</b> 4 CIL, 2.2 l 2002 - 2007 38011 <b>TENSOR PARA BANDA MICRO-V</b> 4 CIL, 2.2 l 2002 - 2007 38177 <b>TENSOR PARA BANDA MICRO-V</b> V-6, 3.0 L 2002 - 2003 38179 <b>TENSOR PARA BANDA MICRO-V</b> V-6, 3.5 L 2004 - 2007 38341				<b>TOYOTA</b> <b>4 RUNNER</b> <b>POLEA</b> V-8, 4.7 L 2003 - 2005 36026 <b>POLEA LOCA</b> V-8, 4.7 L 2006 - 2007 36026 <b>POLEA</b> V-8, 4.7 L 2003 - 2007 36119 <b>POLEA</b> V-8, 4.7 L 2003 - 2004 38001 <b>POLEA</b> 4 CIL, 2.7 l 2000 - 2000 38031 <b>POLEA</b> V-6, 3.4 L 2000 - 2002 38031 <b>TENSOR PARA BANDA MICRO-V</b> V-8, 4.7 L 2003 - 2007 38173 <b>TENSOR PARA BANDA ARBOL DE LEVAS</b> V-8, 4.7 L 2003 - 2007 T41078 <b>TENSOR PARA BANDA ARBOL DE LEVAS</b> V-6, 3.4 L 2000 - 2002 T41204 <b>POLEA PARA BANDA DE TIEMPO</b> V-8, 4.7 L 2003 - 2007 T42031 <b>TENSOR PARA BANDA ARBOL DE LEVAS</b> V-8, 4.7 L 2003 - 2007 T43097 <b>AVALON</b> <b>TENSOR PARA BANDA ARBOL DE LEVAS</b> V-6, 3.0 L 2000 - 2004 T41075 <b>POLEA PARA BANDA DE TIEMPO</b> V-6, 3.0 L 2000 - 2004 T42030 <b>TENSOR PARA BANDA ARBOL DE LEVAS</b> V-6, 3.0 L 2000 - 2004 T43096 <b>CAMRY</b> <b>TENSOR PARA BANDA MICRO-V</b> 4 CIL, 2.4 l 2002 - 2006 38216 <b>TENSOR PARA BANDA ARBOL DE LEVAS</b> 4 CIL, 2.2 l 2000 - 2001 T41067 <b>TENSOR PARA BANDA ARBOL DE LEVAS</b> V-6, 3.0 L 2000 - 2001 T41075 <b>POLEA PARA BANDA DE TIEMPO</b> 4 CIL, 2.2 l 2000 - 2001 T42025 <b>POLEA PARA BANDA DE TIEMPO</b> V-6, 3.0 L 2000 - 2006 T42030 <b>POLEA PARA BANDA DE TIEMPO</b> V-6, 3.3 L 2004 - 2006 T42030 <b>TENSOR PARA BANDA ARBOL DE LEVAS</b> V-6, 3.0 L 2000 - 2001 T43096 <b>TENSOR PARA BANDA ARBOL DE LEVAS</b> V-6, 3.0 L 2002 - 2006 T43098 <b>TENSOR PARA BANDA ARBOL DE LEVAS</b> V-6, 3.3 L 2004 - 2006 T43098 <b>CAMRY SOLARA</b> <b>TENSOR PARA BANDA ARBOL DE LEVAS</b> 4 CIL, 2.2 l 2000 - 2000 T41067 <b>TENSOR PARA BANDA ARBOL DE LEVAS</b> V-6, 3.0 L 2000 - 2000 T41075 <b>POLEA PARA BANDA DE TIEMPO</b> 4 CIL, 2.2 l 2000 - 2000 T42025 <b>POLEA PARA BANDA DE TIEMPO</b> V-6, 3.0 L 2000 - 2000 T42030 <b>TENSOR PARA BANDA ARBOL DE LEVAS</b> V-6, 3.0 L 2000 - 2000 T43096 <b>CELICA</b> <b>POLEA</b> 4 CIL, 1.8 l 2000 - 2005 38018 <b>TENSOR PARA BANDA MICRO-V</b> 4 CIL, 1.8 l 2000 - 2005 38286 <b>COROLLA</b> <b>POLEA</b> 4 CIL, 1.8 l 2000 - 2008 38018 <b>POLEA DEL TENSOR</b> 4 CIL, 1.8 l 2002 - 2002 38018 <b>TENSOR PARA BANDA MICRO-V</b> 4 CIL, 1.8 l 2000 - 2008 38286 <b>TENSOR PARA BANDA MICRO-V</b> 4 CIL, 1.8 l 2005 - 2005 38286 <b>FJ CRUISER</b> <b>TENSOR PARA BANDA MICRO-V</b> V-6, 4.0 L 2007 - 2008 38411 <b>HIGHLANDER</b> <b>TENSOR PARA BANDA MICRO-V</b> 4 CIL, 2.4 l 2001 - 2006 38216 <b>POLEA PARA BANDA DE TIEMPO</b> V-6, 3.0 L 2001 - 2003 T42030 <b>POLEA PARA BANDA DE TIEMPO</b> V-6, 3.3 L 2004 - 2007 T42030 <b>TENSOR PARA BANDA ARBOL DE LEVAS</b> V-6, 3.0 L 2001 - 2003 T43098 <b>TENSOR PARA BANDA ARBOL DE LEVAS</b> V-6, 3.3 L 2004 - 2007 T43098 <b>LAND CRUISER</b> <b>POLEA</b> V-8, 4.7 L 2000 - 2006 36026 <b>POLEA</b> V-8, 4.7 L 2000 - 2006 36119 <b>TENSOR PARA BANDA MICRO-V</b> V-8, 4.7 L 2000 - 2007 38173 <b>TENSOR PARA BANDA ARBOL DE LEVAS</b> V-8, 4.7 L 2000 - 2006 T41078 <b>POLEA PARA BANDA DE TIEMPO</b> V-8, 4.7 L 2000 - 2006 T42031 <b>TENSOR PARA BANDA ARBOL DE LEVAS</b> V-8, 4.7 L 2000 - 2006 T43097 <b>MATRIX</b> <b>POLEA</b> 4 CIL, 1.8 l 2003 - 2008 38018 <b>TENSOR PARA BANDA MICRO-V</b> 4 CIL, 1.8 l 2004 - 2008 38286 <b>TENSOR PARA BANDA MICRO-V</b> 4 CIL, 1.8 l 2003 - 2003 38286 <b>MR2 SPYDER</b> <b>POLEA</b> 4 CIL, 1.8 l 2000 - 2005 38018			
<b>SEAT</b> <b>AHLAMBRA</b> <b>TENSOR PARA BANDA MICRO-V</b> 4 CIL, 1.8 l 2003 - 2007 38148 <b>TENSOR PARA BANDA ARBOL DE LEVAS</b> 4 CIL, 1.8 l 2003 - 2007 T43016 <b>TENSOR PARA BANDA ARBOL DE LEVAS</b> 4 CIL, 1.8 l 2003 - 2007 T43017 <b>ALTEA</b> <b>POLEA LOCA DISTRIBUCION</b> 4 CIL, 2.0 2006 - 2008 T42019 <b>TENSOR PARA BANDA ARBOL DE LEVAS</b> 4 CIL, 2.0 2006 - 2008 T43142 <b>CORDOBA</b> <b>SERPENTIN</b> 4 CIL, 1.6 l 2003 - 2007 TMV-23001 <b>TENSOR PARA BANDA ARBOL DE LEVAS</b> 4 CIL, 1.6 l 2003 - 2007 TPG-23001 <b>IBIZA</b> <b>SERPENTIN</b> 4 CIL, 1.6 l 2003 - 2007 TMV-23001 <b>TENSOR PARA BANDA ARBOL DE LEVAS</b> 4 CIL, 1.6 l 2003 - 2007 TPG-23001 <b>LEON</b> <b>TENSOR PARA BANDA MICRO-V</b> 4 CIL, 1.8 l 2003 - 2005 38148 <b>POLEA LOCA DISTRIBUCION</b> 4 CIL, 2.0 2006 - 2007 T42019 <b>TENSOR PARA BANDA ARBOL DE LEVAS</b> 4 CIL, 1.8 l 2003 - 2005 T43017 <b>TENSOR PARA BANDA ARBOL DE LEVAS</b> 4 CIL, 2.0 2006 - 2007 T43142 <b>TOLEDO</b> <b>TENSOR PARA BANDA MICRO-V</b> 4 CIL, 1.8 l 2003 - 2005 38148 <b>POLEA LOCA DISTRIBUCION</b> 4 CIL, 2.0 2006 - 2007 T42019 <b>TENSOR PARA BANDA ARBOL DE LEVAS</b> 4 CIL, 1.8 l 2003 - 2005 T43017 <b>TENSOR PARA BANDA ARBOL DE LEVAS</b> 4 CIL, 2.0 2006 - 2007 T43142							
<b>SUBARU</b> <b>FORESTER</b> <b>POLEA</b> 4 CIL, 2.5 l 2004 - 2006 38030 <b>POLEA LOCA</b> 4 CIL, 2.5 l 2007 - 2007 38030 <b>POLEA PARA BANDA DE TIEMPO</b> 4 CIL, 2.5 l 2004 - 2006 T42023 <b>POLEA PARA BANDA DE TIEMPO</b> 4 CIL, 2.5 l 2004 - 2006 T42024 <b>IMPREZA</b> <b>POLEA</b> 4 CIL, 2.0 l 2004 - 2005 38030 <b>POLEA</b> 4 CIL, 2.5 l 2004 - 2005 38030 <b>POLEA LOCA</b> 4 CIL, 2.5 l 2006 - 2007 38030 <b>POLEA PARA BANDA DE TIEMPO</b> 4 CIL, 2.0 l 2004 - 2004 T42023 <b>POLEA PARA BANDA DE TIEMPO</b> 4 CIL, 2.5 l 2004 - 2006 T42023 <b>POLEA PARA BANDA DE TIEMPO</b> 4 CIL, 2.0 l 2004 - 2004 T42024 <b>POLEA PARA BANDA DE TIEMPO</b> 4 CIL, 2.5 l 2004 - 2006 T42024 <b>LEGACY</b> <b>POLEA</b> 4 CIL, 2.5 l 2004 - 2005 38030 <b>POLEA LOCA</b> 4 CIL, 2.5 l 2006 - 2007 38030 <b>POLEA PARA BANDA DE TIEMPO</b> 4 CIL, 2.5 l 2006 - 2006 T42023							





TENSOR PARA BANDA MICRO-V	V-6, 2.8 L	1995	-	1997	38175		
TENSOR PARA BANDA MICRO-V	V-6, 2.8 L	1998	-	2005	38193		
TENSOR PARA BANDA MICRO-V	V-6, 3.2 L	2005	-	2005	38193		
TENSOR PARA BANDA ARBOL DE LEVAS	4 CIL, 2.0 L	1995	-	1996	T41079		
TENSOR PARA BANDA ARBOL DE LEVAS	4 CIL, 1.9 L	1995	-	1997	T43006		
<b>POINTER</b>							
TENSOR PARA BANDA ARBOL DE LEVAS	4 CIL, 1.8 L	1998	-	2008	T41079		
TENSOR PARA BANDA MICRO-V	4 CIL, 1.8 L	1998	-	2008	TMV-22001		
TENSOR PARA BANDA MICRO-V	4 CIL, 2.0 L	1998	-	2006	TMV-22001		
TENSOR PARA BANDA MICRO-V	4 CIL, 1.8 L	1998	-	2008	TMV-22002		
TENSOR PARA BANDA MICRO-V	4 CIL, 2.0 L	1998	-	2006	TMV-22002		
<b>POINTER PICK-UP</b>							
TENSOR PARA BANDA MICRO-V	4 CIL, 1.8 L	1998	-	2006	TMV-22001		
TENSOR PARA BANDA MICRO-V	4 CIL, 2.0 L	1998	-	2006	TMV-22001		
TENSOR PARA BANDA MICRO-V	4 CIL, 1.8 L	1998	-	2006	TMV-22002		
TENSOR PARA BANDA MICRO-V	4 CIL, 2.0 L	1998	-	2006	TMV-22002		
<b>POLO</b>							
TENSOR PARA BANDA MICRO-V	4 CIL, 1.6 L	2003	-	2007	TMV-23001		
TENSOR PARA BANDA ARBOL DE LEVAS	4 CIL, 1.6 L	2003	-	2007	TPG-23001		
<b>SHARAN</b>							
TENSOR PARA BANDA MICRO-V	4 CIL, 1.8 L	2003	-	2007	38148		
TENSOR PARA BANDA ARBOL DE LEVAS	4 CIL, 1.8 L	2003	-	2007	T43016		
TENSOR PARA BANDA ARBOL DE LEVAS	4 CIL, 1.8 L	2003	-	2007	T43017		
<b>SPORTVAN</b>							
TENSOR PARA BANDA MICRO-V	4 CIL, 1.6 L	2006	-	2008	TMV-23001		
<b>TOUAREG</b>							
TENSOR PARA BANDA MICRO-V	V-6, 3.2 L	2006	-	2006	38317		
TENSOR PARA BANDA MICRO-V	V-6, 3.6 L	2007	-	2007	38317		
TENSOR PARA BANDA ARBOL DE LEVAS	V-8, 4.2 L	2006	-	2006	T41098		
POLEA LOCA	V-8, 4.2 L	2006	-	2006	T41228		
POLEA LOCA	V-8, 4.2 L	2006	-	2006	T41230		
TENSOR PARA BANDA ARBOL DE LEVAS	V-8, 4.2 L	2006	-	2006	T43032		
<b>VW VAN</b>							
TENSOR PARA BANDA MICRO-V	4 CIL, 1.6 L	2003	-	2006	TMV-23001		
TENSOR PARA BANDA ARBOL DE LEVAS	4 CIL, 1.6 L	2003	-	2005	TPG-23001		
<b>VOLVO</b>							
<b>C70</b>							
POLEA	5 CIL, 2.3 L	2000	-	2004	38018		
POLEA	5 CIL, 2.4 L	2000	-	2004	38018		
TENSOR PARA BANDA MICRO-V	5 CIL, 2.3 L	2004	-	2004	38190		
TENSOR PARA BANDA MICRO-V	5 CIL, 2.4 L	2004	-	2004	38190		
<b>S40</b>							
POLEA	4 CIL, 1.9 L	2000	-	2004	38018		
TENSOR PARA BANDA MICRO-V	4 CIL, 1.9 L	2002	-	2004	38190		
<b>S60</b>							
POLEA	5 CIL, 2.3 L	2001	-	2004	38018		
POLEA	5 CIL, 2.4 L	2001	-	2007	38018		
POLEA	5 CIL, 2.5 L	2003	-	2007	38018		
TENSOR PARA BANDA MICRO-V	5 CIL, 2.5 L	2004	-	2006	38190		
<b>S70</b>							
POLEA	5 CIL, 2.3 L	2000	-	2000	38018		
POLEA	5 CIL, 2.4 L	2000	-	2000	38018		
<b>S80</b>							
POLEA	5 CIL, 2.5 L	2004	-	2006	38018		
POLEA	6 CIL, 2.8 L	2000	-	2001	38018		
POLEA	6 CIL, 2.9 L	2000	-	2005	38018		
TENSOR PARA BANDA MICRO-V	5 CIL, 2.5 L	2005	-	2006	38190		
TENSOR PARA BANDA MICRO-V	6 CIL, 2.9 L	2002	-	2005	38190		
<b>XC90</b>							
TENSOR PARA BANDA MICRO-V	5 CIL, 2.5 L	2003	-	2006	38190		

















<b>T660</b>				<b>CHN Series</b>								
Tensor	-	Caterpillar C15 Diesel	2006	2006	38506	Polea	-	Cummins Signature 600 Diesel	2001	2003	36092	
Tensor	C/Purificador de aire	Caterpillar C15 Diesel	2000	2005	38506	Tensor	-	Mack 6-Cyl. 12.0 L Diesel	2001	2002	36092	
Tensor	-	Caterpillar C15 Diesel	2005	2006	38508	Tensor	-	Mack AC Diesel	2003	2006	36092	
Tensor	C/Purificador de aire	Caterpillar C15 Diesel	2000	2004	38508	Polea	-	Cummins Signature 600 Diesel	2001	2003	36095	
Tensor	-	Caterpillar C15 Diesel	2007	2007	38511	Tensor	-	Mack 6-Cyl. 12.0 L Diesel	2001	2002	38523	
Tensor	-	Cummins ISM Diesel	2001	2004	38521	Tensor	-	Mack AC Diesel	2003	2006	38523	
Tensor	-	Cummins ISX Diesel	2002	2003	38532	Tensor	-	Cummins Signature 600 Diesel	2001	2003	38532	
Tensor	-	Cummins Signature 600 Diesel	2003	2003	38532	Tensor	-	Mack AC Diesel	2003	2006	38532	
Tensor	-	Cummins ISX Diesel	2002	2003	38535	Tensor	-	Cummins Signature 600 Diesel	2001	2003	38532	
Tensor	-	Cummins Signature 600 Diesel	2003	2003	38535	Tensor	-	Cummins Signature 600 Diesel	2001	2003	38535	
Tensor	-	Caterpillar C15 Diesel	2007	2007	38569	Tensor	-	Mack AC Diesel	2003	2006	38589	
Tensor	-	Cummins ISX Diesel	2004	2007	38587	<b>CL Series</b>						
<b>T660</b>												
Polea	-	Caterpillar C15 Diesel	2007	2007	36091	Polea	-	Mack AC Diesel	2006	2007	36092	
Polea	-	Caterpillar C15 Diesel	2007	2007	36093	Tensor	-	Mack AC Diesel	2006	2007	38523	
Tensor	-	Cummins ISX Diesel	2007	2008	38587	Tensor	-	Mack AC Diesel	2006	2007	38589	
<b>T800</b>												
Polea	-	Caterpillar C10 Diesel	1997	2004	36091	<b>CS Series</b>						
Polea	C/Polea Loca Plana	Caterpillar C10 Diesel	1997	2004	36091	Polea	-	Mack AC Diesel	2003	2003	36092	
Polea	-	Caterpillar C12 Diesel	1996	2004	36091	Tensor	-	Mack AC Diesel	2003	2003	38523	
Polea	C/Polea Loca Plana	Caterpillar C12 Diesel	1996	2004	36091	<b>CT Series</b>						
Polea	-	Caterpillar C15 Diesel	2004	2007	36091	Polea	-	Mack AI Diesel	2006	2007	36092	
Polea	C/Purificador de aire	Caterpillar C15 Diesel	2004	2004	36091	Polea	-	Mack AMI Diesel	2006	2006	36092	
Polea	-	Cummins ISM Diesel	2003	2006	36091	Tensor	-	Mack AI Diesel	2006	2007	38589	
Polea	-	Cummins ISX Diesel	1999	2003	36092	Tensor	-	Mack AI Diesel	2006	2006	38589	
Polea	-	Caterpillar C11 Diesel	2003	2008	36093	Tensor	-	Mack AMI Diesel	2006	2006	38589	
Polea	-	Caterpillar C13 Diesel	2004	2007	36093	<b>CTP Series</b>						
Polea	-	Caterpillar C15 Diesel	2004	2007	36093	Tensor	-	Mack MP7 Diesel	2007	2007	38607	
Polea	-	CUMMINS ISL	2006	2006	36093	<b>CV Series</b>						
Polea	-	Cummins ISL Diesel	2001	2008	36093	Polea	-	Mack 6-Cyl. 12.0 L Diesel	2001	2002	36092	
Polea	-	Cummins ISX Diesel	1999	2003	36095	Polea	-	Mack AI Diesel	2003	2007	36092	
Polea	-	Detroit Diesel 6-Cyl. 11.1 L Diesel	2000	2001	38075	Polea	-	Mack AMI Diesel	2003	2006	36092	
Polea	-	Detroit Diesel 6-Cyl. 12.7 L Diesel	2000	2001	38075	Tensor	-	Mack 6-Cyl. 12.0 L Diesel	2001	2002	38523	
Polea	-	DETROIT DIESEL SERIE 60	2001	2001	38075	Tensor	-	MACK AI DIESEL	2005	2005	38523	
Tensor	-	Detroit Diesel 6-Cyl. 11.1 L Diesel	2000	2001	38501	Tensor	-	Mack AI Diesel	2003	2007	38523	
Tensor	-	Detroit Diesel 6-Cyl. 12.7 L Diesel	2000	2001	38501	Tensor	-	Mack AMI Diesel	2003	2006	38523	
Tensor	-	DETROIT DIESEL SERIE 60	2001	2001	38501	Tensor	-	Mack AI Diesel	2006	2007	38589	
Tensor	-	Cummins ISM Diesel	2003	2006	38505	Tensor	-	Mack AMI Diesel	2004	2005	38589	
Tensor	-	Caterpillar C10 Diesel	1997	2004	38506	<b>CX Series</b>						
Tensor	-	Caterpillar C12 Diesel	1996	2004	38506	Polea	-	Mack 6-Cyl. 12.0 L Diesel	2001	2002	36092	
Tensor	C/Purificador de aire	Caterpillar C15 Diesel	2004	2004	38506	Polea	-	Mack AC Diesel	2003	2006	36092	
Tensor	C/Purificador de aire	Caterpillar C15 Diesel	2004	2004	38508	Tensor	-	Mack 6-Cyl. 12.0 L Diesel	2001	2002	38523	
Tensor	-	Caterpillar C15 Diesel	2005	2007	38511	Tensor	-	Mack AC Diesel	2003	2006	38589	
Tensor	-	CUMMINS ISL	2005	2006	38516	Tensor	-	Mack AC Diesel	2003	2005	38611	
Tensor	-	Cummins ISL Diesel	2001	2008	38516	Tensor	-	Mack AC Diesel	2006	2006	38617	
Tensor	-	Cummins ISM Diesel	1999	2004	38521	<b>CXN Series</b>						
Tensor	-	Cummins ISX Diesel	1999	2003	38532	Polea	-	Mack AC Diesel	2006	2007	36092	
Tensor	-	Cummins ISX Diesel	1999	2003	38535	Tensor	-	Mack AC Diesel	2006	2007	38523	
Tensor	-	Caterpillar C15 Diesel	2005	2005	38569	Tensor	-	Mack AC Diesel	2006	2007	38589	
Tensor	C/Cubierta convensio	Caterpillar C15 Diesel	2006	2007	38569	<b>CXP Series</b>						
Tensor	-	Cummins ISX Diesel	2004	2008	38587	Tensor	-	Mack MP7 Diesel	2006	2006	38523	
Tensor	-	Caterpillar C11 Diesel	2003	2008	38590	Tensor	-	Mack MP7 Diesel	2006	2006	38589	
Tensor	-	Caterpillar C13 Diesel	2004	2007	38590	Tensor	-	Mack MP7 Diesel	2007	2007	38607	
Tensor	-	Cummins ISM Diesel	2005	2006	38622	<b>DM Series</b>						
<b>T800B AEROCAB</b>												
Tensor	-	CATERPILLAR C10 DIESEL	1999	2000	38505	Polea	-	Mack 6-Cyl. 12.0 L Diesel	2001	2001	36092	
Tensor	-	CATERPILLAR C12 DIESEL	1999	2000	38505	Tensor	-	Mack 6-Cyl. 12.0 L Diesel	2001	2001	38523	
<b>T800SH AEROCAB</b>												
Tensor	-	CATERPILLAR C10 DIESEL	1999	2000	38505	<b>LE Series</b>						
Tensor	-	CATERPILLAR C12 DIESEL	1999	2000	38505	Polea	-	Mack AI Diesel	2003	2005	36092	
<b>W900</b>												
Polea	C/Polea Loca Plana	Caterpillar C10 Diesel	1997	2004	36091	Tensor	-	Mack AI Diesel	2003	2005	38523	
Polea	C/Polea Loca Plana	Caterpillar C12 Diesel	2000	2004	36091	Tensor	-	Mack AI Diesel	2004	2006	38599	
Polea	-	Caterpillar C15 Diesel	2004	2008	36091	<b>MR Series</b>						
Polea	-	Cummins ISM Diesel	2003	2006	36091	Polea	-	Mack 6-Cyl. 12.0 L Diesel	2001	2002	36092	
Polea	-	Cummins ISX Diesel	1999	2002	36092	Tensor	-	Mack 6-Cyl. 12.0 L Diesel	2001	2002	38523	
Polea	S/ Purificador de aire	Cummins ISX Diesel	2003	2003	36092	Tensor	-	Mack AMI Diesel	2003	2005	38589	
Polea	-	Cummins Signature 600 Diesel	2000	2002	36092	Tensor	-	Mack AI Diesel	2005	2006	38599	
Polea	-	Caterpillar C11 Diesel	2005	2007	36093	Tensor	-	Mack AMI Diesel	2003	2007	38599	
Polea	-	Caterpillar C13 Diesel	2004	2007	36093	<b>RD Series</b>						
Polea	-	Caterpillar C15 Diesel	2004	2008	36093	Polea	-	Mack 6-Cyl. 12.0 L Diesel	2001	2002	36092	
Polea	-	Cummins ISC Diesel	2003	2004	36093	Polea	-	Mack E7 Diesel	2003	2003	36092	
Polea	-	Cummins ISX Diesel	1999	2002	36095	Tensor	-	Mack 6-Cyl. 12.0 L Diesel	2001	2002	38523	
Polea	S/ Purificador de aire	Cummins ISX Diesel	2003	2003	36095	Tensor	-	Mack E7 Diesel	2003	2003	38523	
Polea	-	Cummins Signature 600 Diesel	2000	2002	36095	<b>PETTERBILT</b>						
Polea	-	Detroit Diesel 6-Cyl. 11.1 L Diesel	2000	2001	38075	<b>320</b>						
Polea	-	Detroit Diesel 6-Cyl. 12.7 L Diesel	2000	2001	38075	Polea	-	Caterpillar C7 Diesel	2004	2007	36091	
Tensor	-	Detroit Diesel 6-Cyl. 11.1 L Diesel	2000	2001	38501	Polea	-	Cummins ISM Diesel	2007	2007	36091	
Tensor	-	Detroit Diesel 6-Cyl. 12.7 L Diesel	2000	2001	38501	Polea	-	Caterpillar C7 Diesel	2004	2007	36096	
Tensor	-	Cummins ISM Diesel	2003	2006	38505	Tensor	-	Cummins ISM Diesel	2007	2007	38505	
Tensor	-	Caterpillar C15 Diesel	2004	2007	38511	Tensor	-	Cummins C Series 8.3 L Diesel	1996	1996	38507	
Tensor	-	Cummins ISC Diesel	2003	2004	38516	Tensor	-	Cummins ISC Diesel	1997	1997	38507	
Tensor	-	Cummins ISM Diesel	2002	2004	38521	Tensor	-	Cummins ISM Diesel	2007	2007	38521	
Tensor	-	Cummins ISX Diesel	1999	2002	38532	<b>330</b>						
Tensor	S/ Purificador de aire	Cummins ISX Diesel	2003	2003	38532	Polea	-	Caterpillar 3126 Diesel	1998	2003	36091	
Tensor	-	Cummins Signature 600 Diesel	2000	2002	38532	Polea	-	Caterpillar C7 Diesel	2004	2007	36091	
Tensor	-	Cummins ISX Diesel	1999	2002	38535	Polea	-	Cummins ISC Diesel	1999	2005	36093	
Tensor	S/ Purificador de aire	Cummins ISX Diesel	2003	2003	38535	Polea	-	Caterpillar C7 Diesel	2004	2007	36096	
Tensor	-	Cummins Signature 600 Diesel	2000	2002	38535	Tensor	-	Caterpillar 3116 Diesel	1995	1998	38507	
Tensor	-	Caterpillar C15 Diesel	2004	2005	38569	Tensor	-	Caterpillar 3126 Diesel	1995	1997	38507	
Tensor	C/8-Banda acanalada	Caterpillar C15 Diesel	2006	2007	38569	Tensor	-	Caterpillar 3126 Diesel	1998	2003	38511	
Tensor	-	Cummins ISX Diesel	2004	2007	38587							
Tensor	C/Purificador de aire	Cummins ISX Diesel	2003	2003	38587							
Tensor	-	Caterpillar C11 Diesel	2005	2007	38590							
Tensor	-	Caterpillar C13 Diesel	2004	2007	38590							
Tensor	-	Cummins ISM Diesel	2005	2006	38622							

MACK







		16			
		16			
Tensor	- Volvo VE D12 Diesel	2004	2008	38581	
Tensor	- Volvo VE D16 Diesel	2006	2008	38581	
Tensor	- Volvo D16 Diesel	2008	2008	38585	
Tensor	- Volvo VE D12 Diesel	2004	2008	38585	
Tensor	- Volvo VE D16 Diesel	2006	2008	38585	
Tensor	- Cummins ISX Diesel	2004	2007	38587	
Tensor	C/Purificador de aire Cummins ISX Diesel	2003	2003	38587	
Tensor	C/Purificador de aire Cummins Signature 600 Diesel	2003	2003	38587	
Tensor	- Cummins ISM Diesel	2002	2003	38607	
<b>VNL</b>					
Tensor	CUMMINS N14	2002	2003	38536	
<b>VNL 64T 420</b>					
Polea	DETROIT DIESEL SERIE 60	2001	2001	38076	
Tensor	DETROIT DIESEL SERIE 60	2001	2001	38505	
<b>VNL 64T 420 6X4 TIPICO</b>					
Polea	DETROIT DIESEL SERIE 60	1999	2000	38076	
Tensor	DETROIT DIESEL SERIE 60	1999	2000	38505	
<b>VNL 64T 420 STANDAR</b>					
Polea	DETROIT DIESEL SERIE 60	1999	2000	38076	
Tensor	DETROIT DIESEL SERIE 60	1999	2000	38505	
<b>VNL 64T 610</b>					
Polea	DETROIT DIESEL SERIE 60	1999	2000	38076	
Tensor	DETROIT DIESEL SERIE 60	1999	2000	38505	
<b>VNM</b>					
Tensor	CUMMINS N14	2002	2003	38536	
<b>VT Series</b>					
Tensor	- Volvo VE D16 Diesel	2006	2008	38581	
Tensor	- Volvo VE D16 Diesel	2006	2008	38585	
Tensor	- Cummins ISX Diesel	2006	2006	38587	
<b>WG Series</b>					
Tensor	- Volvo VE D12 Diesel	1998	2001	38531	



A Tomkins Company

# Aplicación por producto automotriz



La marca de más prestigio en bandas, Mangueras, Hidráulica y Neumática



**TCKS & Componentes**

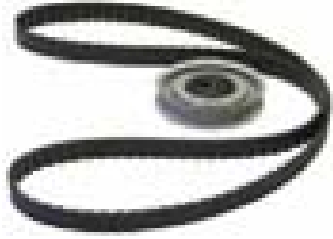

**TCK017**

VOLKSWAGEN	GOLF	4 CIL, 1.8 L	1995	-	1995
VOLKSWAGEN	JETTA	4 CIL, 1.8 L	1995	-	1995



**TCK1013**

HYUNDAI	ATOS	4 CIL, 1.0 L	2000	-	2004
HYUNDAI	ATOS	4 CIL, 1.1 L	2005	-	2010



**TCK1022**

CHEVROLET	ASTRA	4 CIL, 2.0 L	2004	-	2005
CHEVROLET	ZAFIRA	4 CIL, 2.0 L	2004	-	2006



**TCK104**

NISSAN	MAXIMA	V-6, 3.0 L	1993	-	1994
--------	--------	------------	------	---	------



**TCK1094**

CHEVROLET	ASTRA	4 CIL, 1.8 L	2000	-	2003
CHEVROLET	CORSA	4 CIL, 1.4 L	2002	-	2003
CHEVROLET	ZAFIRA	4 CIL, 1.8 L	2000	-	2003

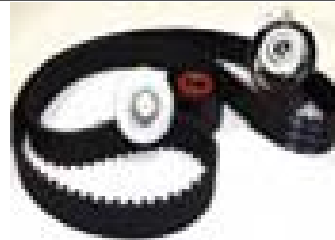

**TCK1095**

NISSAN	APRIO	4 CIL, 1.6 L	2008	-	2010
NISSAN	PLATINA	4 CIL, 1.6 L	2002	-	2010
RENAULT	CLIO	4 CIL, 1.6 L	2003	-	2009
RENAULT	EUROCLIO	4 CIL, 1.6 L	2007	-	2008
RENAULT	KANGOO	4 CIL, 1.6 L	2004	-	2010
RENAULT	KANGOO EXPRESS	4 CIL, 1.6 L	2005	-	2009
RENAULT	SANDERO	4 CIL, 1.6 L	2010	-	2010
RENAULT	STEPWAY	4 CIL, 1.6 L	2010	-	2010



**TCK139**

CHRYSLER	GRAND VOYAGER	V-6, 3.3 L	2000	-	2000
CHRYSLER	LEBARON	V-6, 3.0 L	1993	-	1995
CHRYSLER	VOYAGER	V-6, 3.0 L	1996	-	2001
DODGE	CARAVAN	V-6, 3.0 L	1994	-	1995
DODGE	SPIRIT	V-6, 3.0 L	1994	-	1994

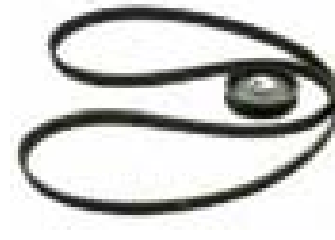

**TCK153**

CHRYSLER	LEBARON	4 CIL, 2.5 L	1993	-	1994
DODGE	CARAVAN	4 CIL, 2.5 L	1995	-	1995
DODGE	SHADOW	4 CIL, 2.2 L	1994	-	1994
DODGE	SHADOW	4 CIL, 2.5 L	1994	-	1994
DODGE	SPIRIT	4 CIL, 2.5 L	1994	-	1994

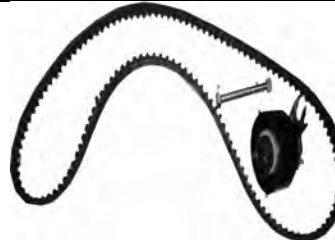

**TCK1548**

SEAT	CORDOBA	4 CIL, 1.6 L	2003	-	2008
SEAT	IBIZA	4 CIL, 1.6 L	2003	-	2009
VOLKSWAGEN	CROSSFOX	4 CIL, 1.6 L	2005	-	2008
VOLKSWAGEN	GOL	4 CIL, 1.6 L	2009	-	2010
VOLKSWAGEN	LUPO	4 CIL, 1.6 L	2004	-	2008
VOLKSWAGEN	POLO	4 CIL, 1.6 L	2005	-	2007
VOLKSWAGEN	SAVEIRO	4 CIL, 1.6 L	2010	-	2010
VOLKSWAGEN	SPORTVAN	4 CIL, 1.6 L	2006	-	2008



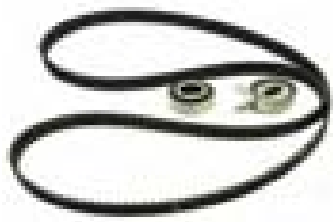

**TCK179**

FORD ESCORT 4 CIL, 1.8 L 1994 - 1996

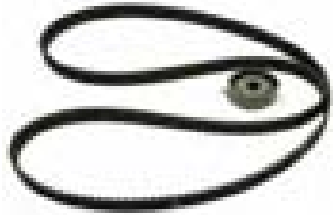

**TCK184**

HONDA CR-V 4 CIL, 2.0 L 1999 - 2001



**TCK192**

CHEVROLET LUMINA V-6, 3.4 L 1993 - 1995  
 CHEVROLET LUMINA V-6, 3.4 L 1997 - 1998

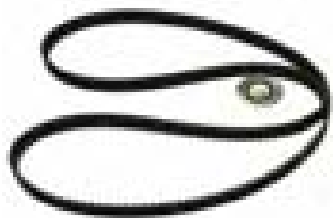

**TCK194**

FORD ESCORT 4 CIL, 1.9 L 1994 - 1996

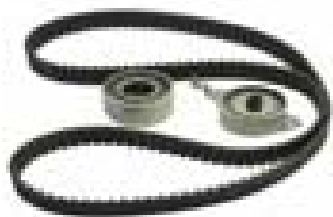

**TCK199**

TOYOTA CAMRY 4 CIL, 2.2 L 2001 - 2001

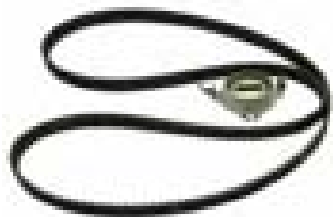

**TCK201**

MITSUBISHI LANCER 4 CIL, 2.0 L 2007 - 2008

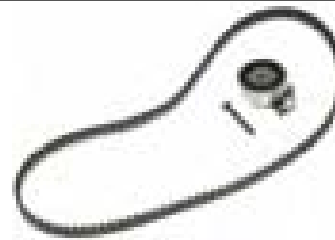

**TCK203**

CHEVROLET CHEVY 4 CIL, 1.6 L 2009 - 2010  
 CHEVROLET CHEVY C2 4 CIL, 1.6 L 2004 - 2008  
 CHEVROLET CHEVY C2 SEDAN 4 CIL, 1.6 L 2004 - 2008  
 CHEVROLET CHEVY JOY 4 CIL, 1.6 L 1994 - 2003  
 CHEVROLET CHEVY PICK-UP 4 CIL, 1.6 L 2002 - 2006  
 CHEVROLET CHEVY POP 4 CIL, 1.6 L 1994 - 2003  
 CHEVROLET CHEVY SWING 4 CIL, 1.6 L 1994 - 2003  
 CHEVROLET MONZA 4 CIL, 1.6 L 1994 - 2004

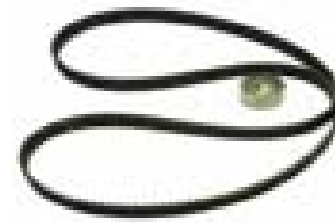

**TCK212**

CHEVROLET TRACKER 4 CIL, 1.6 L 1998 - 2000



**TCK219**

CHRYSLER CONCORDE V-6, 3.5 L 1993 - 1994  
 CHRYSLER NEW YORKER V-6, 3.5 L 1994 - 1994



**TCK224**

HONDA CIVIC 4 CIL, 1.6 L 1997 - 2000

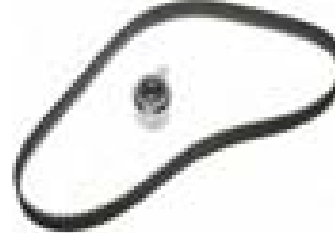

**TCK227**

HONDA CIVIC 4 CIL, 1.6 L 1999 - 2000



**TCK244**

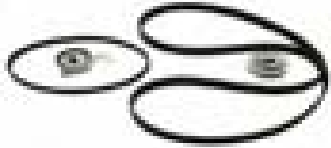

HONDA ACCORD 4 CIL, 2.3 L 1998 - 2002

**TCK245**

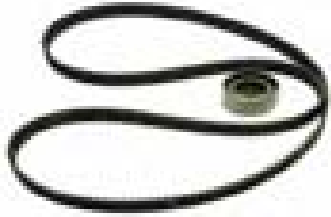

CHRYSLER CIRRUS 4 CIL, 2.0 L 2000 - 2000  
 DODGE NEON 4 CIL, 2.0 L 1995 - 2002  
 DODGE STRATUS 4 CIL, 2.0 L 1995 - 2000

**TCK246**

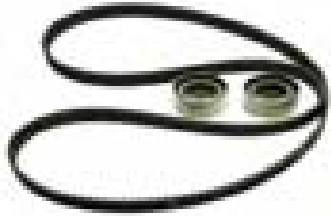

DODGE NEON 4 CIL, 2.0 L 1995 - 1999

**TCK249**



NISSAN FRONTIER V-6, 3.3 L 1999 - 2004  
 NISSAN MAXIMA V-6, 3.0 L 1993 - 1994  
 NISSAN PATHFINDER V-6, 3.0 L 1995 - 1995  
 NISSAN PATHFINDER V-6, 3.3 L 1997 - 2000  
 NISSAN QUEST 6 CIL, 3.3 L 2002 - 2002  
 NISSAN QUEST V-6, 3.0 L 1997 - 1998  
 NISSAN QUEST V-6, 3.3 L 1999 - 2001  
 NISSAN XTERRA V-6, 3.3 L 2000 - 2002

**TCK250**

FORD CONTOUR 4 CIL, 2.0 L 1997 - 1997

**TCK255**

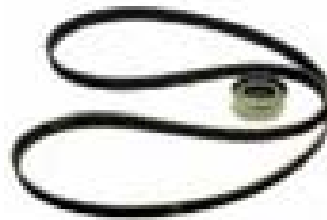

CHRYSLER CONCORDE V-6, 3.5 L 1995 - 1997  
 CHRYSLER NEW YORKER V-6, 3.5 L 1995 - 1996  
 DODGE INTREPID V-6, 3.5 L 1995 - 1997

**TCK257**



TOYOTA CAMRY V-6, 3.0 L 2001 - 2002  
 TOYOTA SIENNA V-6, 3.0 L 2000 - 2003

**TCK258**

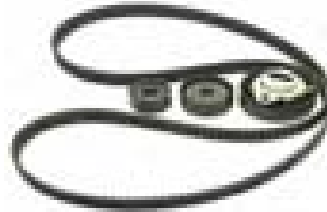

FORD CONTOUR 4 CIL, 2.0 L 1995 - 1997  
 MERCURY MYSTIQUE 4 CIL, 2.0 L 1995 - 1997

**TCK259**

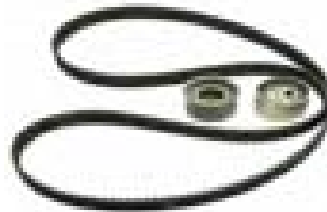

CHRYSLER CIRRUS V-6, 2.5 L 1995 - 2000  
 CHRYSLER SEBRING V-6, 2.5 L 1996 - 2000  
 CHRYSLER SEBRING V-6, 3.0 L 2001 - 2004  
 DODGE STRATUS V-6, 2.5 L 1995 - 2000  
 DODGE STRATUS V-6, 3.0 L 2001 - 2003  
 MITSUBISHI ECLIPSE V-6, 3.0 L 2004 - 2005

**TCK262**

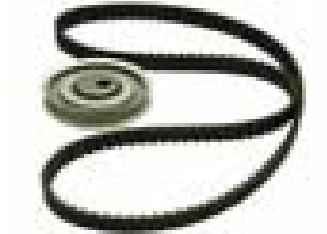

VOLKSWAGEN CABRIO 4 CIL, 2.0 L 1995 - 2002  
 VOLKSWAGEN GOLF 4 CIL, 2.0 L 1995 - 2000  
 VOLKSWAGEN GTI 4 CIL, 2.0 L 1999 - 2000  
 VOLKSWAGEN JETTA 4 CIL, 2.0 L 1995 - 2000  
 VOLKSWAGEN PASSAT 4 CIL, 2.0 L 1995 - 1996



**TCK262A**

VOLKSWAGEN CABRIO 4 CIL, 2.0 L 1996 - 1996

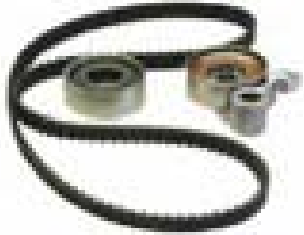

**TCK271**

TOYOTA 4 RUNNER V-6, 3.4 L 2002 - 2002

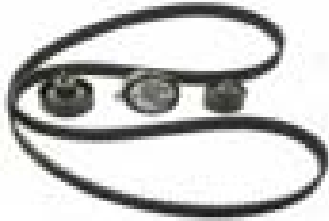

**TCK273**

CHEVROLET LUMINA V-6, 3.4 L 1996 - 1997

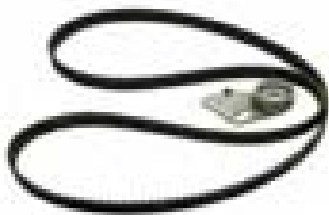

**TCK276**

FORD RANGER 4 CIL, 2.3 L 1995 - 2002  
 FORD RANGER 4 CIL, 2.5 L 1998 - 2001

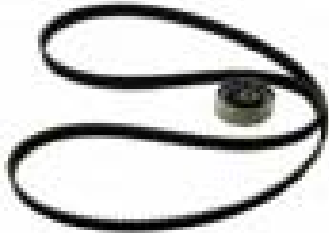

**TCK283**

FORD ESCORT 4 CIL, 2.0 L 1997 - 2002  
 FORD FOCUS 4 CIL, 2.0 L 2000 - 2004



**TCK285**

CADILLAC CATERA V-6, 3.0 L 1998 - 1999  
 SAAB 9 - 5 V-6, 3.0 L 2000 - 2003

SAAB 9 - 5 V-6, 3.0 L 2002 - 2003



**TCK285A**

CADILLAC CATERA V-6, 3.0 L 1999 - 2001



**TCK286**

HONDA ACCORD V-6, 3.0 L 1998 - 2001



**TCK287**

mitsubishi Eclipse V-6, 3.8 L 2007 - 2008  
 mitsubishi Endeavor V-6, 3.8 L 2004 - 2007  
 mitsubishi Galant V-6, 3.8 L 2004 - 2007  
 mitsubishi Montero Sport V-6, 3.5 L 2004 - 2004



**TCK294**

FORD CONTOUR 4 CIL, 2.0 L 1998 - 1999  
 FORD ESCORT 4 CIL, 2.0 L 1998 - 2000  
 MERCURY MYSTIQUE 4 CIL, 2.0 L 1998 - 2000



**TCK294A**

FORD CONTOUR 4 CIL, 2.0 L 1999 - 2000  
 FORD ESCORT 4 CIL, 2.0 L 1999 - 2002  
 FORD FOCUS 4 CIL, 2.0 L 2000 - 2003  
 FORD FOCUS 4 CIL, 2.0 L 2001 - 2001  
 FORD FOCUS 4 CIL, 2.0 L 2004 - 2006  
 FORD ZX2 4 CIL, 2.0 L 2003 - 2003  
 MERCURY MYSTIQUE 4 CIL, 2.0 L 1999 - 2000

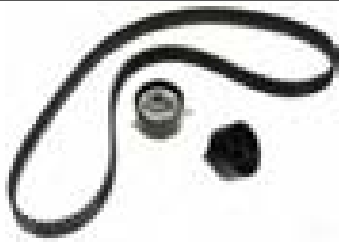

**TCK294B**

FORD ESCAPE 4 CIL, 2.0 L 2001 - 2002

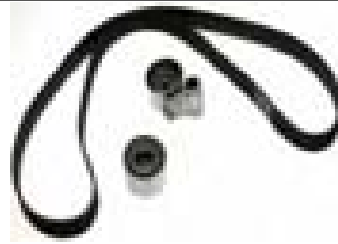

**TCK298**

TOYOTA LAND CRUISER V-8, 4.7 L 2007 - 2007  
TOYOTA TUNDRA V-8, 4.7 L 2007 - 2008



**TCK295**

CHRYSLER 300M V-6, 3.5 L 1999 - 2002  
CHRYSLER CONCORDE V-6, 3.2 L 1998 - 2001  
CHRYSLER CONCORDE V-6, 3.5 L 2002 - 2002  
DODGE INTREPID V-6, 3.2 L 1998 - 2001  
DODGE INTREPID V-6, 3.5 L 2000 - 2002



**TCK305**

CHEVROLET ASTRA 4 CIL, 2.4 L 2004 - 2006  
CHEVROLET ZAFIRA 4 CIL, 2.4 L 2004 - 2006

**TCK295A**

**TCK306**

CHRYSLER 300 C V-6, 3.5 L 2007 - 2009  
CHRYSLER TOWN & COUNTRY V-6, 4.0 L 2008 - 2010  
DODGE CHARGER V-6, 3.5 L 2009 - 2009  
DODGE JOURNEY V-6, 3.5 L 2009 - 2010  
DODGE NITRO V-6, 4.0 L 2009 - 2010

AUDI A4 4 CIL, 1.8 L 2006 - 2006

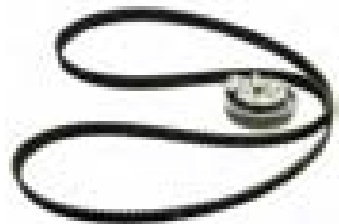

**TCK296**



**TCK309**

CHEVROLET OPTRA 4 CIL, 2.0 L 2006 - 2010

SEAT CORDOBA 4 CIL, 2.0 L 2003 - 2007  
SEAT IBIZA 4 CIL, 2.0 L 2003 - 2009  
VOLKSWAGEN BEETLE 4 CIL, 2.0 L 1998 - 2005  
VOLKSWAGEN GOLF 4 CIL, 2.0 L 1999 - 2006  
VOLKSWAGEN JETTA 4 CIL, 2.0 L 1999 - 2010



**TCK321**

VOLKSWAGEN JETTA 4 CIL, 1.9 L DIESE2000 - 2004



**TCK297**

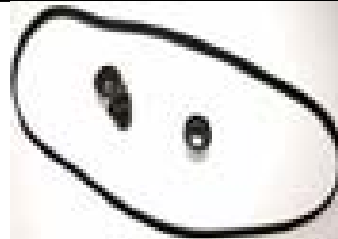

**TCK329**

AUDI A8 V-8, 4.2 L 2007 - 2007

ACURA MDX V-6, 3.5 L 2006 - 2006  
ACURA MDX V-6, 3.7 L 2007 - 2010



ACURA	RL	V-6, 3.5 L	2006	-	2008
ACURA	RL	V-6, 3.7 L	2009	-	2010
ACURA	TL	V-6, 3.2 L	2006	-	2008
ACURA	TL	V-6, 3.5 L	2008	-	2010
ACURA	TL	V-6, 3.7 L	2009	-	2010
ACURA	TSX	V-6, 3.5 L	2010	-	2010
HONDA	ACCORD	V-6, 3.5 L	2008	-	2010
HONDA	ODYSSEY	V-6, 3.5 L	2008	-	2010
HONDA	PILOT	V-6, 3.5 L	2008	-	2010
HONDA	RIDGELINE	V-6, 3.5 L	2008	-	2010

### TCK330

AUDI	A4	V-6, 3.0 L	2006	-	2006
------	----	------------	------	---	------

### TCK331

VOLVO	C30	5 CIL, 2.4 L	2008	-	2010
VOLVO	C30	5 CIL, 2.5 L	2008	-	2010
VOLVO	S40	5 CIL, 2.4 L	2005	-	2008
VOLVO	S40	5 CIL, 2.5 L	2007	-	2008
VOLVO	XC90	5 CIL, 2.5 L	2003	-	2006

### TCK335

CHEVROLET	AVEO	4 CIL, 1.6 L	2009	-	2009
SUZUKI	SWIFT	4 CIL, 1.6 L	2008	-	2008



### TCK901

PEUGEOT	206	4 CIL, 1.4 L	1998	-	2001
---------	-----	--------------	------	---	------



### TCK901A

PEUGEOT	206	4 CIL, 1.4 L	2002	-	2008
---------	-----	--------------	------	---	------

## Catálogo de Poleas, Tensores y Kits 2009

TCK124M



Hyundai H100 4 Cil. 2.4 Lts. Años 2003 al 2005

TCK1570M



Pontiac MATIZ G2 de 4 Cil. 1.0 Lts. Años 2003 al 2009

TCK1565M



Renault Megane y Scenic 4 Cil. 2.0 Lts. Años 2004 al 2009

TCK260M



Volkswagen Pointer 4 Cil. 1.8 Lts. Año 1999 al 2009

TCK282M



Hyundai Attitude 4 Cil. 1.6 Lts. Año 2006 al 2010  
Verna 4 Cil. 1.6 Lts. Año 2005 al 2006

TCK333M



Volkswagen Eurovan 4 Cil. 1.9 Lts. Diesel  
Año 2005 al 2009  
Jetta 4 Cil. 1.9 Lts. Diesel Año 2005 al 2007

TCK324M



Hyundai Verna 4 Cil. 1.5 Lts. Año 2004 al 2006

TCK739M



Volkswagen Eurovan 5 Cil. 2.5 Lts. Año 2000 al 2003



Tensores y Poleas

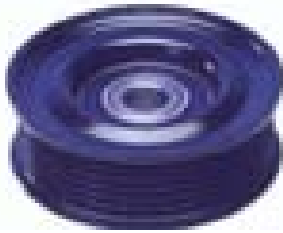

**36026**

TOYOTA	4 RUNNER	V-8, 4.7 L	2003 - 2007
TOYOTA	LAND CRUISER	V-8, 4.7 L	2000 - 2002
TOYOTA	LAND CRUISER	V-8, 4.7 L	2003 - 2006
TOYOTA	SEQUOIA	V-8, 4.7 L	2001 - 2006
TOYOTA	SEQUOIA	V-8, 4.7 L	2007 - 2008
TOYOTA	TUNDRA	V-8, 4.7 L	2000 - 2006
TOYOTA	TUNDRA	V-8, 4.7 L	2007 - 2008



**36079**

SAAB	9-3	4 CIL, 2.0 L	2002 - 2002
SAAB	9-5	4 CIL, 2.3 L	2002 - 2007
SAAB	9-5	V-6, 3.0 L	2003 - 2003



**36086**

HYUNDAI	ACCENT	4 CIL, 1.5 L	2000 - 2003
HYUNDAI	ACCENT	4 CIL, 1.6 L	2001 - 2007
HYUNDAI	ATTITUDE	4 CIL, 1.4 L	2008 - 2010
HYUNDAI	ATTITUDE	4 CIL, 1.6 L	2008 - 2010
HYUNDAI	ATTITUDE	4 CIL, 1.6 L	2006 - 2007



**36087**

NISSAN	ALTIMA	V-6, 3.5 L	2002 - 2006
NISSAN	MAXIMA	V-6, 3.5 L	2002 - 2005
NISSAN	MURANO	6 CIL, 3.5 L	2006 - 2006
NISSAN	MURANO	V-6, 3.5 L	2003 - 2004
NISSAN	QUEST	6 CIL, 3.5 L	2006 - 2006
NISSAN	QUEST	V-6, 3.5 L	2004 - 2005
NISSAN	QUEST	V-6, 3.5 L	2007 - 2007
NISSAN	QUEST	V-6, 3.5 L	2008 - 2009



**36094**

DODGE	RAM SERIES PICKUP	6 CIL, 5.9 L	1995 - 2002
-------	-------------------	--------------	-------------



**36099**

HONDA	PASSPORT	V-6, 3.2 L	1997 - 1997
-------	----------	------------	-------------



**36100**

CHRYSLER	CONCORDE	V-6, 2.7 L	1998 - 2000
CHRYSLER	CONCORDE	V-6, 2.7 L	2001 - 2003
CHRYSLER	INTREPID	V-6, 2.7 L	1998 - 2003
DODGE	INTREPID	V-6, 2.7 L	1998 - 2003
DODGE	INTREPID	V-6, 2.7 L	2004 - 2004
FORD	GRAND MARQUIS	V-8, 4.6 L	2003 - 2006
FORD	MUSTANG	V-8, 4.6 L	2000 - 2004
HONDA	S2000	4 CIL, 2.0 L	2000 - 2003
HONDA	S2000	4 CIL, 2.2 L	2004 - 2005
LINCOLN	TOWN CAR	V-8, 4.6 L	2001 - 2006
MERCURY	GRAND MARQUIS	V-8, 4.6 L	2003 - 2004
MERCURY	GRAND MARQUIS	V-8, 4.6 L	2006 - 2006



**36101**

CHEVROLET	COLORADO	4 CIL, 2.8 L	2004 - 2004
CHEVROLET	COLORADO	4 CIL, 2.8 L	2005 - 2006
CHEVROLET	COLORADO	4 CIL, 2.9 L	2007 - 2007
CHEVROLET	COLORADO	4 CIL, 2.9 L	2008 - 2010
CHEVROLET	COLORADO	5 CIL, 3.5 L	2004 - 2006
CHEVROLET	COLORADO	5 CIL, 3.7 L	2007 - 2007
CHEVROLET	COLORADO	5 CIL, 3.7 L	2008 - 2010
CHEVROLET	TRAILBLAZER	6 CIL, 4.2 L	2002 - 2007
GMC	CANYON	4 CIL, 2.8 L	2004 - 2006
GMC	CANYON	4 CIL, 2.9 L	2007 - 2007
GMC	CANYON	5 CIL, 3.5 L	2004 - 2006
GMC	CANYON	5 CIL, 3.7 L	2007 - 2008
GMC	CANYON	5 CIL, 3.7 L	2009 - 2010
GMC	ENVOY	6 CIL, 4.2 L	2002 - 2007
HUMMER	H3	5 CIL, 3.5 L	2006 - 2007
HUMMER	H3	5 CIL, 3.7 L	2007 - 2007
HUMMER	H3	5 CIL, 3.7 L	2008 - 2010
SAAB	9-7X	6 CIL, 4.2 L	2005 - 2007



**36105**



**36116**

VOLKSWAGEN	BEETLE	5 CIL, 2.5 L	2009	-	2010
VOLKSWAGEN	BORA	5 CIL, 2.5 L	2005	-	2009
VOLKSWAGEN	BORA SPORTWAGEN	5 CIL, 2.5 L	2008	-	2009

NISSAN	FRONTIER	4 CIL, 2.4 L	1998	-	1998
NISSAN	FRONTIER	4 CIL, 2.4 L	1999	-	2001
NISSAN	XTERRA	4 CIL, 2.4 L	2000	-	2001

**36106**



**36118**

VOLKSWAGEN	BORA	5 CIL, 2.5 L	2005	-	2009
VOLKSWAGEN	BORA SPORTWAGEN	5 CIL, 2.5 L	2008	-	2009

NISSAN	PATHFINDER	V-6, 3.0 L	1990	-	1994
NISSAN	PATHFINDER	V-6, 3.0 L	1995	-	1995
NISSAN	PICK-UP	V-6, 3.0 L	1990	-	1996



**36112**



**36119**

ACURA	MDX	V-6, 3.5 L	2003	-	2005
ACURA	MDX	V-6, 3.5 L	2006	-	2006
ACURA	MDX	V-6, 3.7 L	2007	-	2007
ACURA	MDX	V-6, 3.7 L	2008	-	2010
ACURA	RL	V-6, 3.5 L	2006	-	2007
ACURA	RL	V-6, 3.5 L	2008	-	2008
ACURA	RL	V-6, 3.7 L	2009	-	2010
ACURA	TL	V-6, 3.2 L	2004	-	2005
ACURA	TL	V-6, 3.2 L	2006	-	2007
ACURA	TL	V-6, 3.2 L	2008	-	2008
ACURA	TL	V-6, 3.5 L	2008	-	2010
ACURA	TL	V-6, 3.7 L	2009	-	2010
ACURA	TSX	V-6, 3.5 L	2010	-	2010
HONDA	ACCORD	V-6, 3.0 L	2003	-	2007
HONDA	ODYSSEY	V-6, 3.5 L	2005	-	2007
HONDA	ODYSSEY	V-6, 3.5 L	2008	-	2010
HONDA	PILOT	V-6, 3.5 L	2005	-	2007
HONDA	PILOT	V-6, 3.5 L	2008	-	2008
HONDA	RIDGELINE	V-6, 3.5 L	2006	-	2007
HONDA	RIDGELINE	V-6, 3.5 L	2008	-	2010

TOYOTA	4 RUNNER	V-8, 4.7 L	2003	-	2007
TOYOTA	LAND CRUISER	V-8, 4.7 L	2000	-	2002
TOYOTA	LAND CRUISER	V-8, 4.7 L	2003	-	2006
TOYOTA	SEQUOIA	V-8, 4.7 L	2001	-	2006
TOYOTA	SEQUOIA	V-8, 4.7 L	2007	-	2008
TOYOTA	TUNDRA	V-8, 4.7 L	2000	-	2006



**36115**



**36136**

NISSAN	MAXIMA	V-6, 3.0 L	1990	-	1992
NISSAN	MAXIMA	V-6, 3.0 L	1993	-	2004

FORD	KA	4 CIL, 1.6 L	2005	-	2005
------	----	--------------	------	---	------



**36142**

NISSAN	SENTRA	4 CIL, 1.8 L	2006	-	2006
--------	--------	--------------	------	---	------





**36152**

CHEVROLET	CHEVY	4 CIL, 1.6 L	2009	-	2010
CHEVROLET	CHEVY C2	4 CIL, 1.6 L	2004	-	2008
CHEVROLET	CHEVY C2 SEDAN	4 CIL, 1.6 L	2004	-	2008
CHEVROLET	CHEVY JOY	4 CIL, 1.6 L	1994	-	1998
CHEVROLET	CHEVY PICK-UP	4 CIL, 1.6 L	2002	-	2006
CHEVROLET	CHEVY POP	4 CIL, 1.6 L	1994	-	2003
CHEVROLET	CHEVY SWING	4 CIL, 1.6 L	1994	-	2003
CHEVROLET	OPTRA	4 CIL, 2.0 L	2006	-	2010
CHEVROLET	OPTRA	4 CIL, 2.0 L	2006	-	2008



**36169**

CADILLAC	ESCALADE	V-8, 6.2 L	2007	-	2007
CADILLAC	ESCALADE	V-8, 6.2 L	2008	-	2008
CHEVROLET	AVALANCHE	V-8, 5.3 L	2007	-	2007
CHEVROLET	AVALANCHE	V-8, 5.3 L	2008	-	2008
CHEVROLET	EXPRESS	V-8, 5.3 L	2008	-	2008
CHEVROLET	EXPRESS	V-8, 6.0 L	2008	-	2008
CHEVROLET	SILVERADO	V-8, 4.8 L	2008	-	2008
CHEVROLET	SILVERADO	V-8, 5.3 L	2008	-	2008
CHEVROLET	SUBURBAN	V-8, 5.3 L	2008	-	2008
CHEVROLET	SUBURBAN	V-8, 6.0 L	2008	-	2008
CHEVROLET	TAHOE	V-8, 4.8 L	2006	-	2007
CHEVROLET	TAHOE	V-8, 5.3 L	2008	-	2008
GMC	SIERRA	V-8, 6.2 L	2007	-	2008
GMC	YUKON	V-8, 5.3 L	2007	-	2008
GMC	YUKON	V-8, 6.2 L	2007	-	2008
HUMMER	H2	V-8, 6.2 L	2008	-	2008



**36156**

CHRYSLER	PT CRUISER	4 CIL, 2.4 L	2008	-	2010
DODGE	NEON	4 CIL, 2.0 L	2004	-	2006
TOYOTA	CAMRY	4 CIL, 2.5 L	2010	-	2011



**36157**

FORD	E SERIES VAN	V-8, 4.6 L	2008	-	2010
FORD	E SERIES VAN	V-8, 5.4 L	2008	-	2010
FORD	EXPEDITION	V-8, 5.4 L	2005	-	2010
FORD	EXPLORER	V-8, 4.6 L	2007	-	2010
FORD	EXPLORER SPORT TRAC	V-8, 4.6 L	2007	-	2010
FORD	F-150	V-8, 4.6 L	2008	-	2010
FORD	F-350 SUPER DUTY	V-8, 5.4 L	2007	-	2009
FORD	F-450 SUPER DUTY	V-10, 6.8 L	2007	-	2007
FORD	LOBO	V-8, 4.6 L	2005	-	2006
FORD	LOBO	V-8, 4.6 L	2008	-	2010
FORD	LOBO	V-8, 5.4 L	2005	-	2007
FORD	LOBO	V-8, 5.4 L	2008	-	2010
FORD	MUSTANG	V-8, 4.6 L	2006	-	2007
FORD	MUSTANG	V-8, 4.6 L	2008	-	2010
LINCOLN	AVIATOR	V-8, 4.6 L	2003	-	2005
LINCOLN	MARK LT	V-8, 5.4 L	2007	-	2008
LINCOLN	NAVIGATOR	V-8, 5.4 L	2008	-	2009

**36168**

MINI	COOPER	4 CIL, 1.6 L	2005	-	2008
------	--------	--------------	------	---	------

TOYOTA	CAMRY	V-6, 3.5 L	2009	-	2011
TOYOTA	HIGHLANDER	V-6, 3.5 L	2008	-	2010
TOYOTA	RAV 4	V-6, 3.5 L	2008	-	2010
TOYOTA	SIENNA	V-6, 3.5 L	2007	-	2011
TOYOTA	TACOMA	V-6, 4.0 L	2009	-	2010



**36174**

TOYOTA	TACOMA	V-6, 4.0 L	2009	-	2010
--------	--------	------------	------	---	------

**36193**

CHEVROLET	CAPTIVA	4 CIL, 2.4 L	2009	-	2010
CHEVROLET	HHR	4 CIL, 2.4 L	2009	-	2010
CHEVROLET	MALIBU	4 CIL, 2.4 L	2008	-	2010



**36201**

CHEVROLET UPLANDER V-6, 3.9 L 2008 - 2009

**36222**

CHEVROLET	AVALANCHE	V-8, 5.3 L	2008	-	2010
CHEVROLET	EXPRESS	V-8, 5.3 L	2008	-	2010
CHEVROLET	EXPRESS	V-8, 6.0 L	2008	-	2010
CHEVROLET	EXPRESS CARGO VAN	V-6, 4.3 L	2008	-	2010
CHEVROLET	SILVERADO	V-6, 4.3 L	2008	-	2010
CHEVROLET	SILVERADO	V-8, 4.8 L	2008	-	2010
CHEVROLET	SILVERADO	V-8, 5.3 L	2008	-	2010
CHEVROLET	SUBURBAN	V-8, 5.3 L	2008	-	2010
CHEVROLET	SUBURBAN	V-8, 6.0 L	2008	-	2010
CHEVROLET	TAHOE	V-8, 5.3 L	2008	-	2010
GMC	SIERRA	V-8, 5.3 L	2009	-	2010
GMC	SIERRA	V-8, 6.2 L	2009	-	2010
GMC	YUKON	V-8, 6.2 L	2009	-	2010
<u>HUMMER</u>	H2	V-8, 6.2 L	2008	-	2010

**36300**

NISSAN ARMADA V-8, 5.6 L 2006 - 2009  
NISSAN PATHFINDER V-6, 4.0 L 2008 - 2010  
NISSAN TITAN V-8, 5.6 L 2009 - 2009

**36234**

AUDI A3 V-6, 3.2 L 2007 - 2008

**36301**



FORD F-250 SUPER DUTY V-8, 6.4 L DIESEL 2008 - 2010  
FORD F-450 SUPER DUTY V-8, 6.4 L DIESEL 2008 - 2010  
FORD F-550 SUPER DUTY V-8, 6.4 L DIESEL 2008 - 2010

**36263**

CHEVROLET	COLORADO	4 CIL, 2.9 L	2008	-	2010
CHEVROLET	COLORADO	5 CIL, 3.7 L	2008	-	2010
GMC	CANYON	5 CIL, 3.7 L	2009	-	2010
<u>HUMMER</u>	H3	5 CIL, 3.7 L	2008	-	2010

**36305**

MAZDA CX-7 4 CIL, 2.3 L 2006 - 2008

**36271**

<u>NISSAN</u>	350Z	V-6, 3.5 L	2007	-	2009
<u>NISSAN</u>	370Z	V-6, 3.7 L	2009	-	2009

**36306**

MITSUBISHI ECLIPSE V-6, 3.8 L 2007 - 2008

**36299**

<u>NISSAN</u>	350Z	V-6, 3.5 L	2007	-	2009
---------------	------	------------	------	---	------

CADILLAC ESCALADE V-8, 6.2 L 2008 - 2010



**36313**

CHRYSLER	300 C	V-6, 3.5 L	2007 - 2009
CHRYSLER	TOWN & COUNTRY	V-6, 4.0 L	2008 - 2010
DODGE	CHARGER	V-6, 3.5 L	2009 - 2009
DODGE	CHARGER	V-8, 5.7 L	2009 - 2009
DODGE	JOURNEY	V-6, 3.5 L	2009 - 2010
DODGE	RAM 2500	V-8, 5.7 L	2009 - 2009
JEEP	COMMANDER	V-8, 5.7 L	2009 - 2009
JEEP	GRAND CHEROKEE	V-8, 5.7 L	2008 - 2009
JEEP	GRAND CHEROKEE	V-8, 6.1 L	2008 - 2009
VOLKSWAGEN	ROUTAN	V-6, 3.8 L	2009 - 2010

**36315**

DODGE	RAM 4000	V-6, 5.9 L DIESEL	2008 - 2008
DODGE	RAM 4000	V-6, 6.7 L DIESEL	2008 - 2009

**36320**

ACURA	TSX	4 CIL, 2.4 L	2009 - 2009
-------	-----	--------------	-------------



**37008P**

ACURA	MDX	V-6, 3.5 L	2006 - 2006
ACURA	MDX	V-6, 3.7 L	2007 - 2010
ACURA	RL	V-6, 3.5 L	2006 - 2008
ACURA	TL	V-6, 3.2 L	2006 - 2007

**37010P**



VOLKSWAGEN	GOLF	4 CIL, 1.9 L	1997 - 1999
VOLKSWAGEN	JETTA	4 CIL, 1.9 L	1997 - 2002
VOLKSWAGEN	JETTA	4 CIL, 1.9 L DIESE	2000 - 2002
VOLKSWAGEN	PASSAT	4 CIL, 1.9 L	1995 - 1997

**37012P**



VOLKSWAGEN	BEETLE	4 CIL, 1.9 L	1998 - 2001
------------	--------	--------------	-------------

**37013P**



AUDI	A3	4 CIL, 2.0 L	2006 - 2009
AUDI	A3	V-6, 3.2 L	2007 - 2008
AUDI	TT	4 CIL, 1.8 L	2000 - 2003
VOLKSWAGEN	BEETLE	4 CIL, 1.8 L	1999 - 2003
VOLKSWAGEN	BEETLE	4 CIL, 1.9 L	2002 - 2006
VOLKSWAGEN	BEETLE	4 CIL, 2.0 L	1998 - 2003
VOLKSWAGEN	GOLF	4 CIL, 1.8 L	2000 - 2001
VOLKSWAGEN	GOLF	4 CIL, 1.9 L	2000 - 2005
VOLKSWAGEN	GOLF	4 CIL, 2.0 L	2000 - 2003
VOLKSWAGEN	JETTA	4 CIL, 1.8 L	2000 - 2005
VOLKSWAGEN	JETTA	4 CIL, 1.9 L	1999 - 2004
VOLKSWAGEN	JETTA	4 CIL, 1.9 L DIESE	2000 - 2004
VOLKSWAGEN	JETTA	4 CIL, 2.0 L	1999 - 2005

**37014P**



PORSCHE	911	6 CIL, 3.4 L	2000 - 2000
PORSCHE	BOXSTER	6 CIL, 2.7 L	2000 - 2006
PORSCHE	BOXSTER	6 CIL, 3.2 L	2000 - 2006

**37015P**

TOYOTA	COROLLA	4 CIL, 1.8 L	2009 - 2010
TOYOTA	MATRIX	4 CIL, 1.8 L	2009 - 2010

**37017P**

TOYOTA	CAMRY	4 CIL, 2.4 L	2007 - 2009
TOYOTA	COROLLA	4 CIL, 2.4 L	2009 - 2010



TOYOTA	MATRIX	4 CIL, 2.4 L	2009	-	2010
TOYOTA	RAV 4	4 CIL, 2.4 L	2007	-	2008

**37018P**

DODGE	AVENGER	4 CIL, 2.0 L	2007	-	2009
DODGE	AVENGER	4 CIL, 2.4 L	2007	-	2009
DODGE	CALIBER	4 CIL, 2.4 L	2007	-	2009
JEEP	COMPASS	4 CIL, 2.4 L	2007	-	2010
JEEP	PATRIOT	4 CIL, 2.4 L	2007	-	2010

**37026P**

TOYOTA	CAMRY	V-6, 3.5 L	2009	-	2011
TOYOTA	HIGHLANDER	V-6, 3.5 L	2008	-	2010
TOYOTA	RAV 4	V-6, 3.5 L	2008	-	2010
TOYOTA	SIENNA	V-6, 3.5 L	2007	-	2011

**38001**



ACURA	CL	V-6, 3.0 L	1998	-	1999
ACURA	CL	V-6, 3.2 L	2001	-	2003
ACURA	TL	V-6, 3.2 L	1999	-	2003
CADILLAC	DEVILLE	V-8, 4.9 L	1992	-	1992
CADILLAC	EL DORADO	V-8, 4.6 L	1994	-	1997
CADILLAC	ESCALADE	V-8, 5.3 L	2002	-	2004
CADILLAC	ESCALADE	V-8, 5.3 L	2005	-	2005
CADILLAC	ESCALADE	V-8, 5.7 L	1999	-	2000
CADILLAC	ESCALADE	V-8, 6.0 L	2002	-	2006
CADILLAC	ESCALADE	V-8, 6.2 L	2007	-	2007
CADILLAC	SEVILLE	V-8, 4.6 L	1994	-	1997
CHEVROLET	ASTRO	4 CIL, 2.5 L	1989	-	1990
CHEVROLET	ASTRO	V-6, 4.3 L	1989	-	1999
CHEVROLET	AVALANCHE	V-8, 5.3 L	2002	-	2007
CHEVROLET	AVALANCHE	V-8, 5.3 L	2005	-	2006
CHEVROLET	AVALANCHE	V-8, 8.1 L	2002	-	2002
CHEVROLET	AVALANCHE	V-8, 8.1 L	2003	-	2006
CHEVROLET	BLAZER	V-6, 4.3 L	1993	-	2004
CHEVROLET	BLAZER	V-6, 4.3 L	2005	-	2005
CHEVROLET	BLAZER COMPACT	V-6, 2.8 L	1989	-	1989
CHEVROLET	BLAZER COMPACT	V-6, 4.3 L	1989	-	1994
CHEVROLET	BLAZER FULL SIZE	V-8, 5.7 L	1989	-	1994
CHEVROLET	C y K SERIES PICKUP	V-6, 4.3 L	1989	-	1994
CHEVROLET	C y K SERIES PICKUP	V-6, 4.3 L	1995	-	1998
CHEVROLET	C y K SERIES PICKUP	V-8, 5.0 L	1989	-	1996
CHEVROLET	C y K SERIES PICKUP	V-8, 5.0 L	1997	-	1999
CHEVROLET	C y K SERIES PICKUP	V-8, 5.7 L	1988	-	1992
CHEVROLET	C y K SERIES PICKUP	V-8, 5.7 L	1993	-	2000
CHEVROLET	C y K SERIES PICKUP	V-8, 7.4 L	1989	-	1998
CHEVROLET	C y K SERIES PICKUP	V-8, 7.4 L	1999	-	2000
CHEVROLET	C y K SERIES PICKUP	V-8, 8.1 L	2001	-	2002
CHEVROLET	C-20	V-8, 5.7 L	1990	-	1991
CHEVROLET	C-2500	V-8, 5.7 L	1992	-	1992

CHEVROLET	C-2500	V-8, 5.7 L	1993	-	2000
CHEVROLET	C-30	V-8, 5.7 L	1990	-	1993
CHEVROLET	C-35	V-8, 5.7 L	1990	-	1992
CHEVROLET	C-35	V-8, 5.7 L	1993	-	1993
CHEVROLET	C-3500	V-8, 5.7 L	1994	-	2000
CHEVROLET	CAMARO	V-6, 3.4 L	1995	-	1995
CHEVROLET	CAMARO	V-8, 5.7 L	1995	-	1997
CHEVROLET	CAMARO Z28	V-8, 5.7 L	1995	-	1995
CHEVROLET	CAMARO Z28	V-8, 5.7 L	1996	-	1997
CHEVROLET	CAPRICE	V-8, 4.3 L	1996	-	1996
CHEVROLET	CENTURY	V-6, 3.1 L	1998	-	1999
CHEVROLET	CENTURY	V-6, 3.1 L	2000	-	2000
CHEVROLET	EXPRESS	V-6, 4.3 L	1996	-	2003
CHEVROLET	EXPRESS	V-6, 4.3 L	2004	-	2007
CHEVROLET	EXPRESS	V-8, 4.8 L	2003	-	2007
CHEVROLET	EXPRESS	V-8, 5.0 L	1996	-	2002
CHEVROLET	EXPRESS	V-8, 5.3 L	2003	-	2007
CHEVROLET	EXPRESS	V-8, 5.7 L	1996	-	2002
CHEVROLET	EXPRESS	V-8, 6.0 L	2003	-	2007
CHEVROLET	EXPRESS	V-8, 7.4 L	1996	-	2000
CHEVROLET	EXPRESS	V-8, 8.1 L	2001	-	2002
CHEVROLET	EXPRESS CARGO VAN	V-6, 4.3 L	2004	-	2006
CHEVROLET	EXPRESS CARGO VAN	V-6, 4.3 L	2007	-	2007
CHEVROLET	G SERIES VAN	V-6, 4.3 L	1989	-	1998
CHEVROLET	G SERIES VAN	V-8, 5.0 L	1989	-	1998
CHEVROLET	G SERIES VAN	V-8, 5.7 L	1989	-	1998
CHEVROLET	G SERIES VAN	V-8, 7.4 L	1989	-	1998
CHEVROLET	G20 CHEVY VAN	V-6, 4.3 L	1992	-	1997
CHEVROLET	G30 CHEVY VAN	V-8, 5.7 L	1998	-	1998
CHEVROLET	IMPALA	V-6, 3.4 L	2000	-	2004
CHEVROLET	IMPALA	V-6, 3.4 L	2003	-	2005
CHEVROLET	IMPALA	V-6, 3.8 L	2005	-	2005
CHEVROLET	IMPALA SS	V-8, 5.7 L	1995	-	1996
CHEVROLET	LUMINA	V-6, 3.1 L	1998	-	1998
CHEVROLET	LUMINA	V-6, 3.1 L	1999	-	2001
CHEVROLET	MONTE CARLO	V-6, 3.4 L	2004	-	2005
CHEVROLET	P SERIES VAN	V-6, 4.3 L	1996	-	1999
CHEVROLET	P SERIES VAN	V-8, 5.7 L	1996	-	1999
CHEVROLET	P SERIES VAN	V-8, 7.4 L	1996	-	1999
CHEVROLET	P31 VANETTE	V-8, 5.7 L	1996	-	1999
CHEVROLET	PICKUP 1500	V-6, 4.3 L	2003	-	2003
CHEVROLET	S SERIES PICKUP	4 CIL, 2.2 L	1994	-	1997
CHEVROLET	S SERIES PICKUP	4 CIL, 2.5 L	1989	-	1993
CHEVROLET	S SERIES PICKUP	V-6, 2.8 L	1989	-	1993
CHEVROLET	S SERIES PICKUP	V-6, 4.3 L	1989	-	2004
CHEVROLET	S-10	4 CIL, 2.2 L	1994	-	1997
CHEVROLET	S-10	V-6, 4.3 L	1992	-	1992
CHEVROLET	S-10	V-6, 4.3 L	1993	-	2002
CHEVROLET	SILVERADO	V-6, 4.3 L	1999	-	2007
CHEVROLET	SILVERADO	V-6, 4.3 L	2000	-	2001
CHEVROLET	SILVERADO	V-8, 4.8 L	2001	-	2007
CHEVROLET	SILVERADO	V-8, 5.3 L	2000	-	2007
CHEVROLET	SILVERADO	V-8, 6.0 L	2000	-	2007
CHEVROLET	SILVERADO	V-8, 8.1 L	2001	-	2007
CHEVROLET	SILVERADO 2500	V-8, 5.3 L	1999	-	1999
CHEVROLET	SILVERADO 2500 4X4	V-8, 5.3 L	1999	-	2002
CHEVROLET	SILVERADO 2500 4X4	V-8, 6.0 L	1999	-	1999
CHEVROLET	SILVERADO 3500 HD	V-8, 8.1 L	2002	-	2002
CHEVROLET	SILVERADO PICKUP	V-6, 4.3 L	1999	-	2007
CHEVROLET	SILVERADO PICKUP	V-8, 4.8 L	1999	-	2007
CHEVROLET	SILVERADO PICKUP	V-8, 5.3 L	1999	-	2007
CHEVROLET	SILVERADO PICKUP	V-8, 6.0 L	1999	-	2007
CHEVROLET	SILVERADO PICKUP	V-8, 8.1 L	2001	-	2007
CHEVROLET	SILVERADO PICKUP 1500	V-6, 4.3 L	2003	-	2003
CHEVROLET	SSR	V-8, 5.3 L	2003	-	2004
CHEVROLET	SSR	V-8, 6.0 L	2005	-	2006
CHEVROLET	SUBURBAN	V-8, 5.3 L	2000	-	2007
CHEVROLET	SUBURBAN	V-8, 5.7 L	1989	-	1992
CHEVROLET	SUBURBAN	V-8, 5.7 L	1993	-	1999
CHEVROLET	SUBURBAN	V-8, 6.0 L	2000	-	2007
CHEVROLET	SUBURBAN	V-8, 7.4 L	1989	-	1992
CHEVROLET	SUBURBAN	V-8, 7.4 L	1993	-	1999
CHEVROLET	SUBURBAN	V-8, 8.1 L	2001	-	2006
CHEVROLET	TAHOE	V-8, 4.8 L	2000	-	2005
CHEVROLET	TAHOE	V-8, 4.8 L	2006	-	2007
CHEVROLET	TAHOE	V-8, 5.3 L	2000	-	2005
CHEVROLET	TAHOE	V-8, 5.3 L	2006	-	2007
CHEVROLET	TAHOE	V-8, 5.7 L	1995	-	2000



CHEVROLET	TRAILBLAZER	V-8, 5.3 L	2003	-	2007	FORD	SUPER DUTY PICKUP	V-8, 5.4 L	2002	-	2003
CHEVROLET	TRAILBLAZER	V-8, 5.3 L	2004	-	2004	FORD	SUPER DUTY PICKUP	V-8, 5.4 L	2004	-	2006
CHEVROLET	TRAILBLAZER	V-8, 5.3 L	2005	-	2005	FORD	SUPER DUTY PICKUP	V-8, 7.5 L	1994	-	1997
CHEVROLET	TRAILBLAZER	V-8, 6.0 L	2006	-	2006	FORD	SUPER DUTY VAN	V-10, 6.8 L	2003	-	2004
CHEVROLET	TRAILBLAZER	V-8, 6.0 L	2007	-	2007	FORD	SUPER DUTY VAN	V-6, 4.2 L	2001	-	2001
CHEVROLET	TRAILBLAZER EXT	V-8, 5.3 L	2004	-	2004	FORD	SUPER DUTY VAN	V-8, 4.6 L	2003	-	2003
CHEVROLET	VENTURE	V-6, 3.4 L	1998	-	1998	FORD	SUPER DUTY VAN	V-8, 4.6 L	2004	-	2004
CHRYSLER	VOYAGER	V-6, 3.3 L	2000	-	2000	FORD	SUPER DUTY VAN	V-8, 5.4 L	2003	-	2004
DODGE	DAKOTA	V-6, 3.7 L	2004	-	2006	FORD	SUPER DUTY VAN	V-8, 7.5 L	1996	-	1996
DODGE	DAKOTA	V-6, 3.7 L	2007	-	2008	FORD	THUNDERBIRD	V-6, 3.8 L	1994	-	1994
DODGE	DAKOTA	V-8, 4.7 L	2000	-	2007	FORD	THUNDERBIRD	V-6, 3.8 L	1996	-	1997
DODGE	DURANGO	V-6, 3.7 L	2004	-	2005	FORD	THUNDERBIRD	V-8, 3.9 L	2002	-	2003
DODGE	DURANGO	V-6, 3.7 L	2006	-	2006	FORD	WINDSTAR	V-6, 3.8 L	1998	-	2003
DODGE	DURANGO	V-8, 4.7 L	2000	-	2006	GMC	C y K SERIES PICKUP	V-8, 5.7 L	2000	-	2000
DODGE	NITRO	V-6, 3.7 L	2007	-	2008	GMC	C y K SERIES PICKUP	V-8, 7.4 L	2000	-	2000
DODGE	RAM SERIES PICKUP	V-6, 3.7 L	2002	-	2003	GMC	C y K SERIES PICKUP	V-8, 8.1 L	2001	-	2002
DODGE	RAM SERIES PICKUP	V-6, 3.7 L	2004	-	2007	GMC	ENVOY	V-8, 5.3 L	2003	-	2007
DODGE	RAM SERIES PICKUP	V-8, 4.7 L	2002	-	2007	GMC	JIMMY	V-6, 4.3 L	2000	-	2005
FORD	AEROSTAR	V-6, 4.0 L	1996	-	1997	GMC	SAFARI	V-6, 4.3 L	2000	-	2005
FORD	CONTOUR	4 CIL, 2.0 L	1995	-	1997	GMC	SAVANA	V-6, 4.3 L	2000	-	2007
FORD	CONTOUR	4 CIL, 2.0 L	1996	-	1996	GMC	SAVANA	V-8, 4.8 L	2003	-	2007
FORD	CONTOUR	V-6, 2.5 L	1996	-	2000	GMC	SAVANA	V-8, 5.0 L	2000	-	2002
FORD	E SERIES VAN	V-6, 4.2 L	1997	-	2003	GMC	SAVANA	V-8, 5.3 L	2003	-	2007
FORD	E SERIES VAN	V-8, 4.6 L	2002	-	2006	GMC	SAVANA	V-8, 5.7 L	2000	-	2002
FORD	E SERIES VAN	V-8, 4.6 L	2008	-	2010	GMC	SAVANA	V-8, 6.0 L	2003	-	2007
FORD	E SERIES VAN	V-8, 5.4 L	2002	-	2007	GMC	SAVANA	V-8, 7.4 L	2000	-	2000
FORD	E SERIES VAN	V-8, 5.4 L	2008	-	2010	GMC	SAVANA	V-8, 8.1 L	2001	-	2002
FORD	E SERIES VAN	V-8, 7.3 L	1994	-	1994	GMC	SIERRA	V-8, 6.2 L	2007	-	2008
FORD	E SERIES VAN	V-8, 7.5 L	1994	-	1996	GMC	SIERRA SERIES PICKUP	V-6, 4.3 L	2000	-	2007
FORD	ESCORT	4 CIL, 1.9 L	1994	-	1996	GMC	SIERRA SERIES PICKUP	V-8, 4.8 L	2000	-	2007
FORD	ESCORT	4 CIL, 2.0 L	1997	-	2002	GMC	SIERRA SERIES PICKUP	V-8, 5.3 L	2000	-	2007
FORD	EXCURSION	V-8, 4.6 L	2003	-	2003	GMC	SIERRA SERIES PICKUP	V-8, 6.0 L	2000	-	2007
FORD	EXCURSION	V-8, 5.4 L	2004	-	2005	GMC	SIERRA SERIES PICKUP	V-8, 6.2 L	2007	-	2007
FORD	EXPEDITION	V-8, 4.6 L	2003	-	2004	GMC	SIERRA SERIES PICKUP	V-8, 8.1 L	2001	-	2007
FORD	EXPEDITION	V-8, 5.4 L	2003	-	2003	GMC	SONOMA	V-6, 4.3 L	2000	-	2004
FORD	EXPEDITION	V-8, 5.4 L	2005	-	2010	GMC	YUKON	V-8, 4.8 L	2000	-	2007
FORD	EXPEDITION	V-8, 5.4 L	2005	-	2005	GMC	YUKON	V-8, 5.3 L	2000	-	2006
FORD	EXPLORER	V-6, 4.0 L	1994	-	1994	GMC	YUKON	V-8, 5.3 L	2007	-	2008
FORD	EXPLORER	V-6, 4.0 L	1995	-	2007	GMC	YUKON	V-8, 5.7 L	2000	-	2000
FORD	EXPLORER	V-6, 4.0 L	2007	-	2010	GMC	YUKON	V-8, 6.0 L	2000	-	2007
FORD	EXPLORER	V-8, 4.6 L	2002	-	2007	GMC	YUKON	V-8, 6.2 L	2007	-	2008
FORD	EXPLORER	V-8, 4.6 L	2007	-	2010	GMC	YUKON	V-8, 8.1 L	2001	-	2006
FORD	EXPLORER	V-8, 5.0 L	1997	-	1997	HONDA	ACCORD	V-6, 3.0 L	1998	-	2002
FORD	EXPLORER	V-8, 5.0 L	1998	-	2001	HONDA	ODYSSEY	V-6, 3.5 L	1999	-	2002
FORD	EXPLORER SPORT TRAC	V-6, 4.0 L	2001	-	2006	HUMMER	H2	V-8, 6.0 L	2005	-	2007
FORD	EXPLORER SPORT TRAC	V-6, 4.0 L	2007	-	2010	JAGUAR	S-TYPE	V-8, 4.0 L	2000	-	2005
FORD	EXPLORER SPORT TRAC	V-8, 4.6 L	2007	-	2010	JEEP	COMMANDER	V-6, 3.7 L	2006	-	2006
FORD	F SERIES PICKUP	V-6, 4.2 L	1997	-	2006	JEEP	COMMANDER	V-8, 4.7 L	2006	-	2006
FORD	F SERIES PICKUP	V-6, 4.2 L	1998	-	2002	JEEP	GRAND CHEROKEE	V-6, 3.7 L	2005	-	2007
FORD	F SERIES PICKUP	V-8, 4.6 L	2003	-	2004	JEEP	GRAND CHEROKEE	V-8, 4.7 L	1999	-	2007
FORD	F SERIES PICKUP	V-8, 5.4 L	2002	-	2002	JEEP	LIBERTY	V-6, 3.7 L	2002	-	2006
FORD	F SERIES PICKUP	V-8, 5.4 L	2003	-	2004	JEEP	WRANGLER	4 CIL, 2.5 L	1999	-	2000
FORD	F SERIES PICKUP	V-8, 7.5 L	1994	-	1996	LINCOLN	AVIATOR	V-8, 4.6 L	2003	-	2005
FORD	F SERIES PICKUP	V-8, 7.5 L	1997	-	1997	LINCOLN	LS	V-6, 3.0 L	2000	-	2001
FORD	F-150	V-6, 4.2 L	2003	-	2006	LINCOLN	LS	V-6, 3.0 L	2002	-	2002
FORD	F-150	V-6, 4.2 L	2008	-	2008	LINCOLN	LS	V-8, 3.9 L	2000	-	2002
FORD	F-150	V-8, 4.6 L	2008	-	2010	LINCOLN	MARK LT	V-8, 5.4 L	2007	-	2008
FORD	F-350 SUPER DUTY	V-8, 5.4 L	2002	-	2006	LINCOLN	NAVIGATOR	V-8, 5.4 L	2003	-	2004
FORD	F-350 SUPER DUTY	V-8, 5.4 L	2007	-	2010	LINCOLN	NAVIGATOR	V-8, 5.4 L	2008	-	2009
FORD	F-450 SUPER DUTY	V-10, 6.8 L	2007	-	2010	MERCURY	COUGAR	V-6, 3.8 L	1995	-	1997
FORD	F-450 SUPER DUTY	V-8, 7.5 L	1997	-	1997	MERCURY	COUGAR	V-8, 5.0 L	1991	-	1991
FORD	F-550 SUPER DUTY	V-10, 6.8 L	2008	-	2010	MERCURY	MOUNTAINEER	V-6, 4.0 L	1998	-	2005
FORD	LOBO	V-8, 4.6 L	2005	-	2006	MERCURY	MOUNTAINEER	V-8, 4.6 L	2003	-	2005
FORD	LOBO	V-8, 4.6 L	2008	-	2010	MERCURY	MOUNTAINEER	V-8, 5.0 L	1997	-	2001
FORD	LOBO	V-8, 5.4 L	2005	-	2007	MERCURY	MYSTIQUE	4 CIL, 2.0 L	1995	-	1997
FORD	LOBO	V-8, 5.4 L	2008	-	2010	MERCURY	MYSTIQUE	V-6, 2.5 L	1995	-	2000
FORD	MUSTANG	V-6, 4.0 L	2005	-	2007	MERCURY	SABLE / TAURUS	V-6, 3.0 L	1997	-	2004
FORD	MUSTANG	V-6, 4.0 L	2008	-	2010	OLDSMOBILE	BRAVADA	V-6, 4.3 L	1997	-	1997
FORD	MUSTANG	V-8, 4.6 L	2003	-	2007	OLDSMOBILE	SILHOUETTE	V-6, 3.4 L	1998	-	1998
FORD	MUSTANG	V-8, 4.6 L	2005	-	2005	PONTIAC	FIREBIRD	V-6, 3.4 L	1995	-	1995
FORD	MUSTANG	V-8, 4.6 L	2008	-	2010	PONTIAC	FIREBIRD	V-8, 5.7 L	1995	-	1997
FORD	RANGER	4 CIL, 2.3 L	2002	-	2004	PONTIAC	FIREBIRD TRANS AM	V-8, 5.7 L	1997	-	1997
FORD	RANGER	4 CIL, 2.5 L	1998	-	2001	PONTIAC	GRAND PRIX	V-6, 3.1 L	1998	-	2002
FORD	RANGER	V-6, 3.0 L	1999	-	2002	PONTIAC	GRAND PRIX	V-6, 3.8 L	2003	-	2005
FORD	RANGER	V-6, 3.0 L	2003	-	2005	PONTIAC	TRANS SPORT	V-6, 3.4 L	1998	-	1998
FORD	RANGER	V-6, 4.0 L	1994	-	2005	SAAB	9-7X	V-8, 5.3 L	2005	-	2007
FORD	RANGER	V-6, 4.0 L	1999	-	2001	TOYOTA	4 RUNNER	V-8, 4.7 L	2003	-	2004
FORD	SUPER DUTY PICKUP	V-10, 6.8 L	2004	-	2006						



**38002**

CHEVROLET	CELEBRITY	4 CIL, 2.5 L	1989	-	1989
CHEVROLET	G SERIES VAN	V-8, 7.4 L	1992	-	1996
CHEVROLET	LUMINA	4 CIL, 2.5 L	1990	-	1992
FORD	AEROSTAR	V-6, 3.0 L	1994	-	1997
FORD	AEROSTAR	V-6, 4.0 L	1990	-	1992
FORD	AEROSTAR	V-6, 4.0 L	1993	-	1995
FORD	EXPLORER	V-6, 4.0 L	1991	-	1993
FORD	EXPLORER	V-8, 5.0 L	1996	-	1997
FORD	EXPLORER	V-8, 5.0 L	1998	-	2001
MERCURY	MOUNTAINEER	V-8, 5.0 L	1997	-	2001



**38005**

ACURA	SLX	V-6, 3.5 L	1999	-	1999
CHEVROLET	LUMINA APV	V-6, 3.8 L	1995	-	1995
FORD	E SERIES VAN	V-8, 7.3 L	1994	-	1994
FORD	F SERIES PICKUP	V-8, 7.3 L	1994	-	1994
FORD	SUPER DUTY PICKUP	V-8, 7.3 L	1994	-	1994
FORD	WINDSTAR	V-6, 3.0 L	1996	-	2000
FORD	WINDSTAR	V-6, 3.0 L	1998	-	1998
FORD	WINDSTAR	V-6, 3.8 L	1996	-	1997
FORD	PASSPORT	V-6, 3.2 L	1998	-	2002
NISSAN	FRONTIER	V-6, 3.3 L	1999	-	2001
NISSAN	XTERRA	V-6, 3.3 L	2000	-	2001
OLDSMOBILE	SILHOUETTE	V-6, 3.8 L	1995	-	1995
PONTIAC	TRANS SPORT	V-6, 3.8 L	1995	-	1995



**38003**

CHRYSLER	CONCORDE	V-6, 3.3 L	1993	-	1996
CHRYSLER	CONCORDE	V-6, 3.5 L	1993	-	1994
CHRYSLER	CORDOBA	6 CIL, 3.7 L	1981	-	1982
CHRYSLER	DAYTONA	4 CIL, 2.2 L	1990	-	1993
CHRYSLER	DAYTONA	4 CIL, 2.5 L	1990	-	1993
CHRYSLER	DAYTONA	V-6, 3.0 L	1991	-	1993
CHRYSLER	INTREPID	V-6, 3.3 L	1993	-	1997
CHRYSLER	LEBARON	4 CIL, 2.2 L	1983	-	1990
CHRYSLER	LEBARON	4 CIL, 2.5 L	1990	-	1992
CHRYSLER	LEBARON	4 CIL, 2.5 L	1993	-	1994
CHRYSLER	LEBARON	V-6, 3.0 L	1990	-	1992
CHRYSLER	LEBARON	V-6, 3.0 L	1993	-	1995
CHRYSLER	NEW YORKER	4 CIL, 2.2 L	1985	-	1988
CHRYSLER	TOWN & COUNTRY VAN	V-6, 3.0 L	1990	-	1990
DODGE	CARAVAN	4 CIL, 2.5 L	1995	-	1995
DODGE	CARAVAN	V-6, 3.0 L	1995	-	1995
DODGE	CARAVAN	V-6, 3.0 L	1996	-	2000
DODGE	D-150	V-8, 5.2 L	1981	-	1983
DODGE	D-150	V-8, 5.9 L	1981	-	1983
DODGE	D-350	V-8, 5.9 L	1981	-	1983
DODGE	DAKOTA	4 CIL, 2.5 L	1995	-	1995
DODGE	GRAND CARAVAN	V-6, 3.0 L	1995	-	2000
DODGE	INTREPID	V-6, 3.3 L	1994	-	1997
DODGE	SHADOW	4 CIL, 2.2 L	1989	-	1990
DODGE	SHADOW	4 CIL, 2.2 L	1994	-	1994
DODGE	SHADOW	4 CIL, 2.5 L	1989	-	1992
DODGE	SHADOW	4 CIL, 2.5 L	1993	-	1995
DODGE	SPIRIT	4 CIL, 2.5 L	1990	-	1995
DODGE	SPIRIT	4 CIL, 2.5 L	1993	-	1994
DODGE	SPIRIT	V-6, 3.0 L	1994	-	1994
DODGE	SPIRIT	V-6, 3.0 L	1995	-	1995



**38006**

CADILLAC	DEVILLE	V-8, 4.6 L	1998	-	2005
CADILLAC	DTS	V-8, 4.6 L	2006	-	2007
CADILLAC	EL DORADO	V-8, 4.6 L	1994	-	2002
CADILLAC	EL DORADO	V-8, 4.6 L	1998	-	2001
CADILLAC	SEVILLE	V-8, 4.6 L	1994	-	2004
CADILLAC	SRX	V-8, 4.6 L	2004	-	2004
CADILLAC	SRX	V-8, 4.6 L	2005	-	2007
CADILLAC	STS	V-8, 4.6 L	2005	-	2005
CADILLAC	STS	V-8, 4.6 L	2006	-	2007
CADILLAC	XLR	V-8, 4.4 L	2006	-	2006
CADILLAC	XLR	V-8, 4.6 L	2005	-	2005
CHEVROLET	ASTRO	V-6, 4.3 L	1989	-	1989
CHEVROLET	BLAZER	V-6, 4.3 L	1993	-	1995
CHEVROLET	BLAZER COMPACT	V-6, 4.3 L	1989	-	1994
CHEVROLET	BLAZER FULL SIZE	V-8, 5.7 L	1989	-	1994
CHEVROLET	C y K SERIES PICKUP	V-6, 4.3 L	1989	-	1994
CHEVROLET	C y K SERIES PICKUP	V-8, 4.3 L	1995	-	1995
CHEVROLET	C y K SERIES PICKUP	V-8, 5.0 L	1989	-	1995
CHEVROLET	C y K SERIES PICKUP	V-8, 5.7 L	1988	-	1992
CHEVROLET	C y K SERIES PICKUP	V-8, 5.7 L	1993	-	1995
CHEVROLET	C y K SERIES PICKUP	V-8, 6.5 L	1999	-	2002
CHEVROLET	C y K SERIES PICKUP	V-8, 8.1 L	2001	-	2002
CHEVROLET	C-20	V-8, 5.7 L	1990	-	1991
CHEVROLET	C-2500	V-8, 5.7 L	1992	-	1992
CHEVROLET	C-2500	V-8, 5.7 L	1993	-	1995
CHEVROLET	C-30	V-8, 5.7 L	1990	-	1993
CHEVROLET	C-35	V-8, 5.7 L	1990	-	1992
CHEVROLET	C-35	V-8, 5.7 L	1993	-	1993
CHEVROLET	C-3500	V-8, 5.7 L	1994	-	1995
CHEVROLET	CAMARO	V-6, 3.8 L	1995	-	2002
CHEVROLET	CAMARO	V-8, 5.7 L	1998	-	2000
CHEVROLET	CAMARO Z28	V-8, 5.7 L	1998	-	2002
CHEVROLET	CORVETTE	V-8, 5.7 L	1997	-	2004
CHEVROLET	CUTLASS	V-6, 3.1 L	1997	-	1998
CHEVROLET	EIGHTY EIGHT	V-6, 3.8 L	1995	-	1995
CHEVROLET	EQUINOX	V-6, 3.4 L	2005	-	2007
CHEVROLET	EXPRESS	V-8, 6.5 L	1999	-	2002
CHEVROLET	EXPRESS	V-8, 8.1 L	2001	-	2002
CHEVROLET	G SERIES VAN	V-6, 4.3 L	1989	-	1991
CHEVROLET	G SERIES VAN	V-8, 5.0 L	1989	-	1991
CHEVROLET	G SERIES VAN	V-8, 5.7 L	1989	-	1991
CHEVROLET	IMPALA	V-6, 3.5 L	2006	-	2006



**38004**

DODGE	INTREPID	V-6, 3.5 L	1997	-	1997
DODGE	SHADOW	4 CIL, 2.2 L	1989	-	1989
DODGE	SHADOW	4 CIL, 2.5 L	1989	-	1989



CHEVROLET	IMPALA	V-6, 3.8 L	2000	-	2004	FORD	RANGER	V-6, 3.0 L	1994	-	2003
CHEVROLET	IMPALA	V-6, 3.8 L	2005	-	2005	FORD	RANGER	V-6, 3.0 L	1996	-	2002
CHEVROLET	IMPALA	V-6, 3.9 L	2006	-	2006	FORD	SUPER DUTY VAN	V-8, 4.6 L	2004	-	2004
CHEVROLET	IMPALA	V-8, 5.3 L	2006	-	2006	FORD	TAURUS	V-6, 3.8 L	1991	-	1991
CHEVROLET	LUMINA	V-6, 3.8 L	1998	-	1998	FORD	THUNDERBIRD	V-6, 3.8 L	1991	-	1995
CHEVROLET	LUMINA	V-6, 3.8 L	1999	-	1999	FORD	THUNDERBIRD	V-6, 3.8 L	1994	-	1994
CHEVROLET	MALIBU	V-6, 3.1 L	1997	-	2003	FORD	THUNDERBIRD	V-8, 4.6 L	1994	-	1997
CHEVROLET	MALIBU	V-6, 3.5 L	2004	-	2007	FORD	TOPAZ	4 CIL, 2.3 L	1988	-	1991
CHEVROLET	MALIBU	V-6, 3.5 L	2005	-	2005	FORD	TOPAZ	4 CIL, 2.3 L	1994	-	1994
CHEVROLET	MALIBU	V-6, 3.9 L	2006	-	2007	FORD	WINDSTAR	V-6, 3.0 L	1995	-	2000
CHEVROLET	MONTE CARLO	V-6, 3.8 L	2004	-	2005	FORD	WINDSTAR	V-6, 3.0 L	1998	-	1998
CHEVROLET	S SERIES PICKUP	V-6, 4.3 L	1989	-	1995	FORD	WINDSTAR	V-6, 3.8 L	1995	-	1995
CHEVROLET	S-10	V-6, 4.3 L	1994	-	1995	FORD	ZX2	4 CIL, 2.0 L	2003	-	2003
CHEVROLET	SILVERADO	V-8, 6.6 L	2001	-	2001	GMC	C y K SERIES PICKUP	V-8, 6.5 L	2000	-	2002
CHEVROLET	SILVERADO 2500 4X4	V-8, 6.5 L	1999	-	1999	GMC	C y K SERIES PICKUP	V-8, 8.1 L	2001	-	2002
CHEVROLET	SUBURBAN	V-8, 5.7 L	1989	-	1992	GMC	ENVOY	6 CIL, 4.2 L	2002	-	2007
CHEVROLET	SUBURBAN	V-8, 5.7 L	1993	-	1995	GMC	SAVANA	V-8, 6.5 L	2000	-	2002
CHEVROLET	TAHOE	V-8, 5.7 L	1995	-	1995	GMC	SAVANA	V-8, 8.1 L	2001	-	2002
CHEVROLET	TRAILBLAZER	6 CIL, 4.2 L	2002	-	2007	GMC	SIERRA SERIES PICKUP	V-8, 6.6 L	2001	-	2001
CHEVROLET	TRAILBLAZER	6 CIL, 4.2 L	2005	-	2005	JEEP	LIBERTY	4 CIL, 2.4 L	2002	-	2005
CHEVROLET	UPLANDER	V-6, 3.5 L	2005	-	2005	JEEP	WRANGLER	4 CIL, 2.4 L	2003	-	2006
CHEVROLET	UPLANDER	V-6, 3.5 L	2006	-	2007	LINCOLN	AVIATOR	V-8, 4.6 L	2003	-	2005
CHEVROLET	UPLANDER	V-6, 3.9 L	2006	-	2007	LINCOLN	CONTINENTAL	V-8, 4.6 L	1995	-	2002
CHEVROLET	UPLANDER	V-6, 3.9 L	2008	-	2009	LINCOLN	MARK LT	V-8, 5.4 L	2007	-	2008
CHEVROLET	VENTURE	V-6, 3.4 L	1999	-	2004	LINCOLN	MARK VIII	V-8, 4.6 L	1994	-	1996
CHEVROLET	VENTURE	V-6, 3.4 L	2005	-	2005	LINCOLN	NAVIGATOR	V-8, 5.4 L	2003	-	2003
FORD	AEROSTAR	V-6, 3.0 L	1995	-	1997	LINCOLN	NAVIGATOR	V-8, 5.4 L	2008	-	2009
FORD	BRONCO	V-8, 5.0 L	1994	-	1996	LINCOLN	TOWN CAR	V-8, 4.6 L	1991	-	1992
FORD	BRONCO	V-8, 5.8 L	1994	-	1996	LINCOLN	TOWN CAR	V-8, 4.6 L	1993	-	2006
FORD	CONTOUR	4 CIL, 2.0 L	1998	-	1998	MAZDA	MAZDA 3	4 CIL, 2.3 L	2010	-	2010
FORD	CONTOUR	V-6, 2.5 L	1995	-	2000	MAZDA	MAZDA 6	4 CIL, 2.3 L	2008	-	2008
FORD	CROWN VICTORIA	V-8, 4.6 L	1996	-	2004	MERCURY	COUGAR	V-6, 3.8 L	1988	-	1988
FORD	E SERIES VAN	V-8, 4.6 L	2004	-	2006	MERCURY	COUGAR	V-8, 4.6 L	1994	-	1997
FORD	E SERIES VAN	V-8, 4.6 L	2008	-	2010	MERCURY	GRAND MARQUIS	V-8, 4.2 L	1982	-	1982
FORD	E SERIES VAN	V-8, 5.0 L	1994	-	1996	MERCURY	GRAND MARQUIS	V-8, 4.6 L	1992	-	2006
FORD	E SERIES VAN	V-8, 5.4 L	2004	-	2007	MERCURY	GRAND MARQUIS	V-8, 4.6 L	1993	-	2005
FORD	E SERIES VAN	V-8, 5.4 L	2008	-	2010	MERCURY	GRAND MARQUIS	V-8, 5.0 L	1982	-	1984
FORD	E SERIES VAN	V-8, 5.8 L	1994	-	1996	MERCURY	MARINER	V-6, 3.0 L	2008	-	2009
FORD	ECOSPORT	4 CIL, 2.0 L	2004	-	2005	MERCURY	MILAN	V-6, 3.0 L	2006	-	2007
FORD	ECOSPORT	4 CIL, 2.0 L	2006	-	2007	MERCURY	MILAN	V-6, 3.0 L	2009	-	2009
FORD	ECOSPORT	4 CIL, 2.0 L	2008	-	2010	MERCURY	MOUNTAINEER	V-8, 4.6 L	2003	-	2005
FORD	ESCAPE	V-6, 3.0 L	2001	-	2004	MERCURY	MOUNTAINEER	V-8, 5.0 L	1998	-	2001
FORD	ESCAPE	V-6, 3.0 L	2008	-	2009	MERCURY	MYSTIQUE	4 CIL, 2.0 L	1998	-	1998
FORD	ESCORT	4 CIL, 2.0 L	1998	-	2002	MERCURY	MYSTIQUE	V-6, 2.5 L	1995	-	2000
FORD	EXPEDITION	V-8, 4.6 L	2003	-	2003	MERCURY	SABLE / TAURUS	V-6, 3.0 L	1996	-	2005
FORD	EXPEDITION	V-8, 5.4 L	2003	-	2003	MERCURY	SABLE / TAURUS	V-6, 3.8 L	1993	-	1994
FORD	EXPEDITION	V-8, 5.4 L	2005	-	2010	OLDSMOBILE	CUTLASS	V-6, 3.1 L	1997	-	1999
FORD	EXPLORER	V-8, 4.6 L	2003	-	2007	OLDSMOBILE	EIGHTY EIGHT	V-6, 3.8 L	1995	-	1996
FORD	EXPLORER	V-8, 4.6 L	2007	-	2010	OLDSMOBILE	EIGHTY EIGHT	V-6, 3.8 L	1999	-	1999
FORD	EXPLORER	V-8, 5.0 L	1997	-	1997	OLDSMOBILE	LSS	V-6, 3.8 L	1997	-	1999
FORD	EXPLORER	V-8, 5.0 L	1998	-	2001	OLDSMOBILE	SILHOUETTE	V-6, 3.4 L	1999	-	2000
FORD	EXPLORER SPORT TRAC	V-8, 4.6 L	2007	-	2010	PONTIAC	AZTEK	V-6, 3.4 L	2001	-	2004
FORD	F SERIES PICKUP	V-8, 4.6 L	2004	-	2004	PONTIAC	AZTEK	V-6, 3.4 L	2005	-	2005
FORD	F SERIES PICKUP	V-8, 5.0 L	1993	-	1994	PONTIAC	BONNEVILLE	V-6, 3.8 L	1994	-	2005
FORD	F SERIES PICKUP	V-8, 5.0 L	1995	-	1996	PONTIAC	FIREBIRD	V-6, 3.8 L	1995	-	2002
FORD	F SERIES PICKUP	V-8, 5.4 L	2004	-	2004	PONTIAC	FIREBIRD	V-8, 5.7 L	1998	-	2000
FORD	F SERIES PICKUP	V-8, 5.8 L	1990	-	1994	PONTIAC	FIREBIRD TRANS AM	V-8, 5.7 L	1998	-	2002
FORD	F SERIES PICKUP	V-8, 5.8 L	1995	-	1997	PONTIAC	G6	V-6, 3.5 L	2007	-	2008
FORD	F-200	V-8, 5.8 L	1990	-	1991	PONTIAC	G6	V-6, 3.9 L	2006	-	2006
FORD	F-250	V-8, 5.0 L	1993	-	1996	PONTIAC	G6	V-6, 3.9 L	2007	-	2007
FORD	F-350 SUPER DUTY	V-8, 5.0 L	1993	-	1996	PONTIAC	GRAND AM	V-6, 3.4 L	1999	-	2004
FORD	F-350 SUPER DUTY	V-8, 5.4 L	2010	-	2010	PONTIAC	GRAND AM	V-6, 3.4 L	2005	-	2005
FORD	F-350 SUPER DUTY	V-8, 5.8 L	1992	-	1992	PONTIAC	GRAND PRIX	V-6, 3.8 L	1997	-	2005
FORD	F-350 SUPER DUTY	V-8, 5.8 L	1993	-	1997	PONTIAC	MONTANA	V-6, 3.4 L	1999	-	2002
FORD	F-450 SUPER DUTY	V-10, 6.8 L	2008	-	2010	PONTIAC	MONTANA	V-6, 3.9 L	2006	-	2008
FORD	F-550 SUPER DUTY	V-10, 6.8 L	2008	-	2010	PONTIAC	TRANS SPORT	V-6, 3.4 L	1999	-	1999
FORD	FUSION	V-6, 3.0 L	2007	-	2008	SAAB	9-7X	6 CIL, 4.2 L	2005	-	2007
FORD	FUSION	V-6, 3.0 L	2009	-	2009	SATURN	AURA	V-6, 3.5 L	2007	-	2007
FORD	GRAND MARQUIS	V-8, 4.6 L	2005	-	2006	SATURN	RELAY	V-6, 3.9 L	2006	-	2007
FORD	MUSTANG	V-6, 3.8 L	1998	-	2001	SATURN	VUE	V-6, 3.5 L	2004	-	2007
FORD	MUSTANG	V-6, 3.8 L	2002	-	2004						
FORD	MUSTANG	V-8, 4.6 L	1996	-	2002						
FORD	MUSTANG	V-8, 4.6 L	2008	-	2010						
FORD	MUSTANG	V-8, 5.0 L	1982	-	1984						
FORD	MUSTANG	V-8, 5.0 L	1994	-	1995						
FORD	RANGER	4 CIL, 2.3 L	1994	-	1994						
FORD	RANGER	4 CIL, 2.3 L	1995	-	2004						
FORD	RANGER	4 CIL, 2.5 L	1998	-	2001						

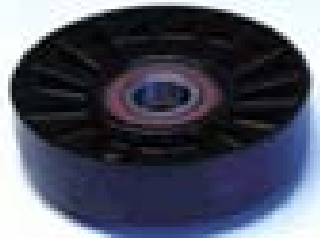

**38007**



**38008**

					PONTIAC	TRANS SPORT	V-6, 3.4 L	1996	-	1997
CADILLAC	DEVILLE	V-8, 4.9 L	1991	-						
CADILLAC	DEVILLE	V-8, 4.9 L	1993	-						
CHEVROLET	ASTRO	V-6, 4.3 L	1990	-						
CHEVROLET	CAVALIER	V-6, 2.8 L	1989	-						
CHEVROLET	CAVALIER	V-6, 3.1 L	1990	-						
CHEVROLET	CAVALIER	V-6, 3.1 L	1993	-						
CHEVROLET	CELEBRITY	V-6, 2.8 L	1987	-						
CHEVROLET	CELEBRITY	V-6, 3.1 L	1990	-						
CHEVROLET	CENTURY	V-6, 2.8 L	1987	-						
CHEVROLET	CENTURY	V-6, 3.1 L	1994	-						
CHEVROLET	CUTLASS	V-6, 2.8 L	1987	-						
CHEVROLET	CUTLASS	V-6, 3.1 L	1989	-						
CHEVROLET	CUTLASS	V-6, 3.1 L	1993	-						
CHEVROLET	CUTLASS EUROSPORT	V-6, 2.8 L	1987	-						
CHEVROLET	G SERIES VAN	V-8, 7.4 L	1990	-						
CHEVROLET	IMPALA	V-6, 3.8 L	2004	-						
CHEVROLET	IMPALA	V-6, 3.8 L	2005	-						
CHEVROLET	LUMINA	V-6, 3.1 L	1990	-						
CHEVROLET	LUMINA	V-6, 3.1 L	1996	-						
CHEVROLET	LUMINA APV	V-6, 3.1 L	1990	-						
CHEVROLET	LUMINA APV	V-6, 3.4 L	1996	-						
CHEVROLET	VENTURE	V-6, 3.4 L	1997	-						
FORD	BRONCO	V-8, 5.0 L	1994	-						
FORD	BRONCO	V-8, 5.8 L	1994	-						
FORD	E SERIES VAN	V-6, 4.2 L	1997	-						
FORD	E SERIES VAN	V-8, 5.0 L	1994	-						
FORD	E SERIES VAN	V-8, 5.8 L	1994	-						
FORD	EXPLORER	V-8, 5.0 L	1996	-						
FORD	F SERIES PICKUP	V-6, 4.2 L	1997	-						
FORD	F SERIES PICKUP	V-6, 4.2 L	1998	-						
FORD	F SERIES PICKUP	V-8, 5.0 L	1987	-						
FORD	F SERIES PICKUP	V-8, 5.0 L	1995	-						
FORD	F SERIES PICKUP	V-8, 5.8 L	1988	-						
FORD	F SERIES PICKUP	V-8, 5.8 L	1995	-						
FORD	F-150	V-6, 4.2 L	1998	-						
FORD	F-200	V-8, 5.0 L	1990	-						
FORD	F-200	V-8, 5.8 L	1990	-						
FORD	F-250	V-8, 5.0 L	1992	-						
FORD	F-250	V-8, 5.0 L	1993	-						
FORD	F-350 SUPER DUTY	V-8, 5.0 L	1990	-						
FORD	F-350 SUPER DUTY	V-8, 5.0 L	1993	-						
FORD	F-350 SUPER DUTY	V-8, 5.8 L	1992	-						
FORD	F-350 SUPER DUTY	V-8, 5.8 L	1993	-						
FORD	SUPER DUTY VAN	V-6, 4.2 L	2001	-						
FORD	TAURUS	V-6, 3.8 L	1989	-						
FORD	THUNDERBIRD	V-6, 3.8 L	1990	-						
FORD	THUNDERBIRD	V-6, 3.8 L	1994	-						
FORD	THUNDERBIRD	V-8, 5.0 L	1992	-						
FORD	TOPAZ	4 CIL, 2.3 L	1988	-						
MERCURY	COUGAR	V-6, 3.8 L	1991	-						
MERCURY	COUGAR XR7	V-6, 3.8 L	1993	-						
MERCURY	SABLE / TAURUS	V-6, 3.8 L	1990	-						
OLDSMOBILE	CUTLASS CIERA	V-6, 3.1 L	1995	-						
OLDSMOBILE	CUTLASS SUPREME	V-6, 3.1 L	1995	-						
OLDSMOBILE	EIGHTY EIGHT	V-6, 3.8 L	1996	-						
OLDSMOBILE	EIGHTY EIGHT	V-6, 3.8 L	1999	-						
OLDSMOBILE	LSS	V-6, 3.8 L	1997	-						
OLDSMOBILE	SILHOUETTE	V-6, 3.1 L	1991	-						
OLDSMOBILE	SILHOUETTE	V-6, 3.4 L	1996	-						
OLDSMOBILE	SILHOUETTE	V-6, 3.4 L	1997	-						
PONTIAC	BONNEVILLE	V-6, 3.8 L	1996	-						
PONTIAC	GRAND AM	V-6, 3.1 L	1995	-						
PONTIAC	GRAND AM	V-6, 3.1 L	1997	-						
PONTIAC	GRAND PRIX	V-6, 3.1 L	1995	-						
PONTIAC	GRAND PRIX	V-6, 3.1 L	1997	-						
PONTIAC	GRAND PRIX	V-6, 3.8 L	1997	-						
PONTIAC	TRANS SPORT	V-6, 3.1 L	1995	-						
ACURA	SLX	V-6, 3.5 L	1999	-						
BMW	Z4	6 CIL, 2.5 L	2003	-						
BMW	Z4	6 CIL, 2.5 L	2004	-						
BMW	Z4	6 CIL, 3.0 L	2003	-						
BMW	Z4	6 CIL, 3.0 L	2004	-						
CADILLAC	CTS	V-8, 5.7 L	2004	-						
CADILLAC	CTS	V-8, 6.0 L	2006	-						
CADILLAC	ESCALADE	V-8, 5.7 L	1999	-						
CHEVROLET	ASTRO	V-6, 4.3 L	1996	-						
CHEVROLET	BLAZER	V-6, 4.3 L	1996	-						
CHEVROLET	BLAZER	V-6, 4.3 L	2005	-						
CHEVROLET	C y K SERIES PICKUP	V-6, 4.3 L	1996	-						
CHEVROLET	C y K SERIES PICKUP	V-8, 5.0 L	1996	-						
CHEVROLET	C y K SERIES PICKUP	V-8, 5.0 L	1997	-						
CHEVROLET	C y K SERIES PICKUP	V-8, 5.7 L	1996	-						
CHEVROLET	C y K SERIES PICKUP	V-8, 7.4 L	1996	-						
CHEVROLET	C y K SERIES PICKUP	V-8, 7.4 L	1999	-						
CHEVROLET	C y K SERIES PICKUP	V-8, 8.1 L	2001	-						
CHEVROLET	C-2500	V-8, 5.7 L	1996	-						
CHEVROLET	C-3500	V-8, 5.7 L	1996	-						
CHEVROLET	CAMARO	V-8, 5.7 L	1998	-						
CHEVROLET	CAMARO Z28	V-8, 5.7 L	1998	-						
CHEVROLET	CORVETTE	V-8, 5.7 L	1997	-						
CHEVROLET	CORVETTE	V-8, 6.0 L	2005	-						
CHEVROLET	CORVETTE	V-8, 7.0 L	2006	-						
CHEVROLET	EXPRESS	V-6, 4.3 L	1996	-						
CHEVROLET	EXPRESS	V-6, 4.3 L	2004	-						
CHEVROLET	EXPRESS	V-8, 5.0 L	1996	-						
CHEVROLET	EXPRESS	V-8, 5.7 L	1996	-						
CHEVROLET	EXPRESS	V-8, 6.6 L	2007	-						
CHEVROLET	EXPRESS	V-8, 7.4 L	1996	-						
CHEVROLET	EXPRESS	V-8, 8.1 L	2001	-						
CHEVROLET	EXPRESS CARGO VAN	V-6, 4.3 L	2004	-						
CHEVROLET	EXPRESS CARGO VAN	V-6, 4.3 L	2007	-						
CHEVROLET	EXPRESS CARGO VAN	V-6, 4.3 L	2008	-						
CHEVROLET	G SERIES VAN	V-6, 4.3 L	1996	-						
CHEVROLET	G SERIES VAN	V-8, 5.0 L	1996	-						
CHEVROLET	G SERIES VAN	V-8, 5.7 L	1996	-						
CHEVROLET	G SERIES VAN	V-8, 7.4 L	1996	-						
CHEVROLET	G20 CHEVY VAN	V-6, 4.3 L	1996	-						
CHEVROLET	G30 CHEVY VAN	V-8, 5.7 L	1998	-						
CHEVROLET	P SERIES VAN	V-6, 4.3 L	1996	-						
CHEVROLET	P SERIES VAN	V-8, 5.7 L	1996	-						
CHEVROLET	P SERIES VAN	V-8, 7.4 L	1996	-						
CHEVROLET	P31 VANETTE	V-8, 5.7 L	1996	-						
CHEVROLET	PICKUP 1500	V-6, 4.3 L	2003	-						
CHEVROLET	S SERIES PICKUP	V-6, 4.3 L	1996	-						
CHEVROLET	S-10	V-6, 4.3 L	1996	-						
CHEVROLET	SILVERADO	V-6, 4.3 L	1999	-						
CHEVROLET	SILVERADO	V-6, 4.3 L	2000	-						
CHEVROLET	SILVERADO	V-6, 4.3 L	2008	-						
CHEVROLET	SILVERADO	V-8, 6.6 L	2001	-						
CHEVROLET	SILVERADO PICKUP	V-6, 4.3 L	1999	-						
CHEVROLET	SILVERADO PICKUP 1500	V-6, 4.3 L	2003	-						
CHEVROLET	SUBURBAN	V-8, 5.7 L	1996	-						
CHEVROLET	SUBURBAN	V-8, 7.4 L	1996	-						
CHEVROLET	TAHOE	V-8, 5.7 L	1996	-						
FORD	AEROSTAR	V-6, 4.0 L	1996	-						
FORD	CONTOUR	4 CIL, 2.0 L	1998	-						
FORD	ESCAPE	4 CIL, 2.0 L	2001	-						
FORD	ESCAPE	4 CIL, 2.0 L	2003	-						
FORD	ESCAPE	V-6, 3.0 L	2005	-						
FORD	EXPLORER	V-6, 4.0 L	1993	-						
FORD	EXPLORER	V-6, 4.0 L	1995	-						
FORD	EXPLORER	V-6, 4.0 L	2007	-						
FORD	EXPLORER	V-8, 5.0 L	1997	-						





## Catálogo de Poleas, Tensores y Kits 2009

FORD	EXPLORER	V-8, 5.0 L	1998	-	2001
FORD	EXPLORER SPORT TRAC	V-6, 4.0 L	2001	-	2001
FORD	EXPLORER SPORT TRAC	V-6, 4.0 L	2007	-	2009
FORD	FOCUS	4 CIL., 2.0 L	2000	-	2003
FORD	FOCUS	4 CIL., 2.0 L	2002	-	2002
FORD	FUSION	V-6, 3.0 L	2007	-	2008
FORD	FUSION	V-6, 3.0 L	2009	-	2009
FORD	RANGER	V-6, 4.0 L	1994	-	2004
FORD	RANGER	V-6, 4.0 L	1999	-	2001
FORD	WINDSTAR	V-6, 3.8 L	1998	-	2003
GMC	C y K SERIES PICKUP	V-8, 5.7 L	2000	-	2000
GMC	C y K SERIES PICKUP	V-8, 7.4 L	2000	-	2000
GMC	C y K SERIES PICKUP	V-8, 8.1 L	2001	-	2002
GMC	JIMMY	V-6, 4.3 L	2000	-	2005
GMC	SAFARI	V-6, 4.3 L	2000	-	2005
GMC	SAVANA	V-6, 4.3 L	2000	-	2007
GMC	SAVANA	V-8, 5.0 L	2000	-	2002
GMC	SAVANA	V-8, 5.7 L	2000	-	2002
GMC	SAVANA	V-8, 6.6 L	2006	-	2007
GMC	SAVANA	V-8, 7.4 L	2000	-	2000
GMC	SAVANA	V-8, 8.1 L	2001	-	2002
GMC	SIERRA SERIES PICKUP	V-6, 4.3 L	2000	-	2007
GMC	SIERRA SERIES PICKUP	V-8, 5.3 L	2004	-	2007
GMC	SIERRA SERIES PICKUP	V-8, 6.6 L	2001	-	2007
GMC	SONOMA	V-6, 4.3 L	2000	-	2004
GMC	YUKON	V-8, 5.7 L	2000	-	2000
HONDA	PASSPORT	V-6, 3.2 L	1998	-	2002
HUMMER	H1	V-8, 6.6 L	2006	-	2007
MAZDA	MAZDA 6	4 CIL., 2.3 L	2006	-	2007
MAZDA	MX-5 MIATA	4 CIL., 2.0 L	2006	-	2007
MERCURY	MARINER	V-6, 3.0 L	2005	-	2005
MERCURY	MILAN	V-6, 3.0 L	2006	-	2007
MERCURY	MILAN	V-6, 3.0 L	2009	-	2009
MERCURY	MOUNTAINEER	V-6, 4.0 L	1998	-	2003
MERCURY	MYSTIQUE	4 CIL., 2.0 L	1998	-	2000
PONTIAC	FIREBIRD	V-8, 5.7 L	1998	-	2002
PONTIAC	FIREBIRD TRANS AM	V-8, 5.7 L	1998	-	2002



# 38009

CADILLAC	CATERA	V-6, 3.0 L	1997	-	1997
CADILLAC	CATERA	V-6, 3.0 L	1998	-	2001
CADILLAC	CTS	V-6, 3.2 L	2003	-	2003
CADILLAC	CTS	V-6, 3.2 L	2004	-	2004
CADILLAC	ESCALADE	V-8, 5.3 L	2002	-	2004
CADILLAC	ESCALADE	V-8, 5.3 L	2005	-	2005
CADILLAC	ESCALADE	V-8, 6.0 L	2002	-	2006
CADILLAC	ESCALADE	V-8, 6.2 L	2007	-	2007
CADILLAC	ESCALADE	V-8, 6.2 L	2008	-	2010
CHEVROLET	ASTRO	V-6, 4.3 L	1990	-	1995
CHEVROLET	AVALANCHE	V-8, 5.3 L	2002	-	2007
CHEVROLET	AVALANCHE	V-8, 5.3 L	2005	-	2006
CHEVROLET	AVALANCHE	V-8, 5.3 L	2008	-	2010
CHEVROLET	AVALANCHE	V-8, 8.1 L	2002	-	2002
CHEVROLET	AVALANCHE	V-8, 8.1 L	2003	-	2006
CHEVROLET	C y K SERIES PICKUP	V-8, 7.4 L	1994	-	1995
CHEVROLET	CAMARO	V-6, 3.4 L	1995	-	1995
CHEVROLET	CAMARO	V-6, 3.8 L	1996	-	1996
CHEVROLET	CAMARO	V-8, 5.7 L	1995	-	1995
CHEVROLET	CAMARO Z28	V-8, 5.7 L	1995	-	1995
CHEVROLET	CAVALIER	V-6, 2.8 L	1989	-	1989
CHEVROLET	CAVALIER	V-6, 3.1 L	1990	-	1992
CHEVROLET	CAVALIER	V-6, 3.1 L	1993	-	1993
CHEVROLET	CELEBRITY	V-6, 2.8 L	1987	-	1989
CHEVROLET	CENTURY	V-6, 2.8 L	1987	-	1988
CHEVROLET	CORVETTE	V-8, 5.7 L	1992	-	1992
CHEVROLET	CORVETTE	V-8, 5.7 L	1993	-	1993
CHEVROLET	CORVETTE	V-8, 6.0 L	2005	-	2005
CHEVROLET	CORVETTE	V-8, 6.0 L	2006	-	2007
CHEVROLET	CUTLASS	V-6, 3.1 L	1997	-	1998

CHEVROLET	EIGHTY EIGHT	V-6, 3.8 L	1995	-	1995
CHEVROLET	EQUINOX	V-6, 3.4 L	2005	-	2007
CHEVROLET	EXPRESS	V-8, 4.8 L	2003	-	2007
CHEVROLET	EXPRESS	V-8, 5.3 L	2003	-	2007
CHEVROLET	EXPRESS	V-8, 5.3 L	2008	-	2010
CHEVROLET	EXPRESS	V-8, 6.0 L	2003	-	2007
CHEVROLET	EXPRESS	V-8, 6.0 L	2008	-	2010
CHEVROLET	G SERIES VAN	V-6, 4.3 L	1992	-	1996
CHEVROLET	G SERIES VAN	V-8, 5.0 L	1992	-	1995
CHEVROLET	G SERIES VAN	V-8, 5.7 L	1992	-	1996
CHEVROLET	G SERIES VAN	V-8, 7.4 L	1994	-	1995
CHEVROLET	G20 CHEVY VAN	V-6, 4.3 L	1995	-	1996
CHEVROLET	IMPALA	V-6, 3.5 L	2006	-	2006
CHEVROLET	IMPALA	V-6, 3.8 L	2004	-	2004
CHEVROLET	IMPALA	V-6, 3.8 L	2005	-	2005
CHEVROLET	IMPALA	V-6, 3.9 L	2006	-	2006
CHEVROLET	LUMINA	V-6, 3.1 L	1990	-	1993
CHEVROLET	LUMINA APV	V-6, 3.1 L	1990	-	1995
CHEVROLET	MALIBU	V-6, 3.1 L	1997	-	2003
CHEVROLET	MALIBU	V-6, 3.5 L	2004	-	2007
CHEVROLET	MALIBU	V-6, 3.5 L	2005	-	2005
CHEVROLET	MALIBU	V-6, 3.9 L	2006	-	2007
CHEVROLET	MALIBU	V-6, 3.9 L	2006	-	2007
CHEVROLET	SILVERADO	V-8, 4.8 L	2001	-	2007
CHEVROLET	SILVERADO	V-8, 4.8 L	2008	-	2010
CHEVROLET	SILVERADO	V-8, 5.3 L	2000	-	2007
CHEVROLET	SILVERADO	V-8, 5.3 L	2008	-	2010
CHEVROLET	SILVERADO	V-8, 5.3 L	2000	-	2007
CHEVROLET	SILVERADO	V-8, 6.0 L	2000	-	2007
CHEVROLET	SILVERADO	V-8, 8.1 L	2001	-	2007
CHEVROLET	SILVERADO 2500	V-8, 5.3 L	1999	-	1999
CHEVROLET	SILVERADO 2500 4X4	V-8, 5.3 L	1999	-	2002
CHEVROLET	SILVERADO 2500 4X4	V-8, 6.0 L	1999	-	1999
CHEVROLET	SILVERADO 3500 HD	V-8, 8.1 L	2002	-	2002
CHEVROLET	SILVERADO PICKUP	V-8, 4.8 L	1999	-	2007
CHEVROLET	SILVERADO PICKUP	V-8, 5.3 L	1999	-	2007
CHEVROLET	SILVERADO PICKUP	V-8, 6.0 L	1999	-	2007
CHEVROLET	SILVERADO PICKUP	V-8, 8.1 L	2001	-	2007
CHEVROLET	SSR	V-8, 5.3 L	2003	-	2004
CHEVROLET	SSR	V-8, 6.0 L	2005	-	2006
CHEVROLET	SUBURBAN	V-8, 5.3 L	2000	-	2007
CHEVROLET	SUBURBAN	V-8, 5.3 L	2008	-	2010
CHEVROLET	SUBURBAN	V-8, 6.0 L	2000	-	2007
CHEVROLET	SUBURBAN	V-8, 6.0 L	2008	-	2010
CHEVROLET	SUBURBAN	V-8, 7.4 L	1994	-	1995
CHEVROLET	SUBURBAN	V-8, 8.1 L	2001	-	2006
CHEVROLET	TAHOE	V-8, 4.8 L	2000	-	2005
CHEVROLET	TAHOE	V-8, 4.8 L	2006	-	2007
CHEVROLET	TAHOE	V-8, 5.3 L	2000	-	2005
CHEVROLET	TAHOE	V-8, 5.3 L	2006	-	2007
CHEVROLET	TAHOE	V-8, 5.3 L	2008	-	2010
CHEVROLET	TRAILBLAZER	V-8, 5.3 L	2003	-	2007
CHEVROLET	TRAILBLAZER	V-8, 5.3 L	2004	-	2004
CHEVROLET	TRAILBLAZER	V-8, 5.3 L	2005	-	2005
CHEVROLET	TRAILBLAZER	V-8, 6.0 L	2006	-	2006
CHEVROLET	TRAILBLAZER	V-8, 6.0 L	2007	-	2007
CHEVROLET	TRAILBLAZER EXT	V-8, 5.3 L	2004	-	2004
CHEVROLET	UPLANDER	V-6, 3.5 L	2005	-	2005
CHEVROLET	UPLANDER	V-6, 3.5 L	2006	-	2007
CHEVROLET	UPLANDER	V-6, 3.9 L	2006	-	2007
CHEVROLET	UPLANDER	V-6, 3.9 L	2008	-	2009
CHEVROLET	VENTURE	V-6, 3.4 L	1999	-	2004
CHEVROLET	VENTURE	V-6, 3.4 L	2005	-	2005
CHRYSLER	GRAND VOYAGER	V-6, 3.0 L	2000	-	2000
CHRYSLER	VOYAGER	V-6, 3.0 L	2000	-	2000
DODGE	CARAVAN	V-6, 3.0 L	1996	-	2000
DODGE	DAKOTA	V-6, 3.7 L	2004	-	2006
DODGE	DAKOTA	V-6, 3.7 L	2007	-	2008
DODGE	DAKOTA	V-8, 4.7 L	2000	-	2007
DODGE	DURANGO	V-6, 3.7 L	2004	-	2005
DODGE	DURANGO	V-6, 3.7 L	2006	-	2006
DODGE	DURANGO	V-8, 4.7 L	2000	-	2006
DODGE	GRAND CARAVAN	V-6, 3.0 L	1996	-	2000
DODGE	INTREPID	V-6, 2.7 L	2002	-	2003
DODGE	NITRO	V-6, 3.7 L	2007	-	2008
DODGE	NITRO	V-6, 4.0 L	2007	-	2008
DODGE	NITRO	V-6, 4.0 L	2009	-	2010
DODGE	RAM 1500	V-6, 3.7 L	2006	-	2007
DODGE	RAM 2500	V-8, 4.7 L	2004	-	2007
DODGE	RAM 2500	V-8, 4.7 L	2002	-	2003



DODGE	RAM SERIES PICKUP	V-6, 3.7 L	2002	-	2003
DODGE	RAM SERIES PICKUP	V-6, 3.7 L	2004	-	2007
DODGE	RAM SERIES PICKUP	V-8, 4.7 L	2002	-	2007
DODGE	RAM SERIES PICKUP	V-8, 4.7L	2002	-	2003
FORD	E SERIES VAN	V-6, 4.2 L	1997	-	2003
FORD	F SERIES PICKUP	V-6, 4.2 L	1997	-	2004
FORD	F SERIES PICKUP	V-6, 4.2 L	1998	-	2002
FORD	F-150	V-6, 4.2 L	2003	-	2006
FORD	MUSTANG	V-6, 3.8 L	1994	-	2003
FORD	MUSTANG	V-6, 3.8 L	1996	-	2001
FORD	RANGER	4 CIL, 2.3 L	1994	-	1994
FORD	RANGER	4 CIL, 2.3 L	1995	-	1997
FORD	TAURUS	V-6, 3.8 L	1988	-	1993
FORD	THUNDERBIRD	V-6, 3.8 L	1989	-	1997
FORD	THUNDERBIRD	V-6, 3.8 L	1994	-	1994
FORD	WINDSTAR	V-6, 3.8 L	1995	-	1998
GMC	ENVOY	V-8, 5.3 L	2003	-	2007
GMC	SAVANA	V-8, 4.8 L	2003	-	2007
GMC	SAVANA	V-8, 5.3 L	2003	-	2007
GMC	SAVANA	V-8, 6.0 L	2003	-	2007
GMC	SIERRA	V-8, 5.3 L	2009	-	2010
GMC	SIERRA	V-8, 6.2 L	2007	-	2008
GMC	SIERRA	V-8, 6.2 L	2009	-	2010
GMC	SIERRA SERIES PICKUP	V-8, 4.8 L	2000	-	2007
GMC	SIERRA SERIES PICKUP	V-8, 5.3 L	2000	-	2007
GMC	SIERRA SERIES PICKUP	V-8, 6.0 L	2000	-	2007
GMC	SIERRA SERIES PICKUP	V-8, 6.2 L	2007	-	2007
GMC	SIERRA SERIES PICKUP	V-8, 8.1 L	2001	-	2007
GMC	YUKON	V-8, 4.8 L	2000	-	2007
GMC	YUKON	V-8, 5.3 L	2000	-	2006
GMC	YUKON	V-8, 5.3 L	2007	-	2008
GMC	YUKON	V-8, 6.0 L	2000	-	2007
GMC	YUKON	V-8, 6.2 L	2007	-	2008
GMC	YUKON	V-8, 6.2 L	2009	-	2010
GMC	YUKON	V-8, 8.1 L	2001	-	2006
HUMMER	H2	V-8, 6.0 L	2006	-	2007
HUMMER	H2	V-8, 6.2 L	2008	-	2010
JEEP	COMMANDER	V-6, 3.7 L	2006	-	2006
JEEP	COMMANDER	V-8, 4.7 L	2006	-	2006
JEEP	GRAND CHEROKEE	V-6, 3.7 L	2005	-	2007
JEEP	GRAND CHEROKEE	V-8, 4.7 L	1999	-	2007
JEEP	LIBERTY	V-6, 3.7 L	2002	-	2007
JEEP	LIBERTY	V-6, 3.7 L	2005	-	2005
JEEP	LIBERTY	V-6, 3.7 L	2008	-	2009
MERCURY	COUGAR	V-6, 3.8 L	1991	-	1997
MERCURY	COUGAR XR7	V-6, 3.8 L	1993	-	1994
MERCURY	SABLE / TAURUS	V-6, 3.8 L	1990	-	1992
MERCURY	SABLE / TAURUS	V-6, 3.8 L	1993	-	1995
OLDSMOBILE	CUTLASS	V-6, 3.1 L	1997	-	1999
OLDSMOBILE	EIGHTY EIGHT	V-6, 3.8 L	1995	-	1996
OLDSMOBILE	EIGHTY EIGHT	V-6, 3.8 L	1999	-	1999
OLDSMOBILE	LSS	V-6, 3.8 L	1997	-	1999
OLDSMOBILE	NINETY EIGHT	V-6, 3.8 L	1995	-	1995
OLDSMOBILE	SILHOUETTE	V-6, 3.4 L	1999	-	2000
PONTIAC	AZTEK	V-6, 3.4 L	2001	-	2004
PONTIAC	AZTEK	V-6, 3.4 L	2005	-	2005
PONTIAC	BONNEVILLE	V-6, 3.8 L	1995	-	2003
PONTIAC	G6	V-6, 3.5 L	2005	-	2005
PONTIAC	G6	V-6, 3.5 L	2006	-	2008
PONTIAC	G6	V-6, 3.9 L	2006	-	2006
PONTIAC	G6	V-6, 3.9 L	2007	-	2007
PONTIAC	GRAND AM	V-6, 3.4 L	1999	-	2004
PONTIAC	GRAND AM	V-6, 3.4 L	2005	-	2005
PONTIAC	GRAND PRIX	V-6, 3.8 L	1997	-	2005
PONTIAC	MONTANA	V-6, 3.4 L	1999	-	2005
PONTIAC	MONTANA	V-6, 3.5 L	2005	-	2005
PONTIAC	MONTANA	V-6, 3.5 L	2006	-	2006
PONTIAC	MONTANA	V-6, 3.9 L	2006	-	2008
PONTIAC	TORRENT	V-6, 3.4 L	2006	-	2008
PONTIAC	TRANS SPORT	V-6, 3.1 L	1995	-	1995
PONTIAC	TRANS SPORT	V-6, 3.4 L	1999	-	1999
SAAB	9 - 5	V-6, 3.0 L	2000	-	2003
SAAB	9 - 5	V-6, 3.0 L	2002	-	2003
SAAB	9-7X	V-8, 5.3 L	2005	-	2007
SATURN	AURA	V-6, 3.5 L	2007	-	2007
SATURN	L-SERIES	V-6, 3.0 L	2000	-	2005
SATURN	RELAY	V-6, 3.5 L	2005	-	2006
SATURN	RELAY	V-6, 3.9 L	2006	-	2007

SATURN	VUE	V-6, 3.0 L	2002	-	2003
--------	-----	------------	------	---	------



**38010**

CHEVROLET	TRACKER	4 CIL, 2.0 L	1999	-	2003
SATURN	S-SERIES	4 CIL, 1.9 L	1991	-	1999
SUZUKI	AERIO	4 CIL, 2.3 L	2004	-	2004
SUZUKI	AERIO	4 CIL, 2.3 L	2005	-	2006
SUZUKI	VITARA	4 CIL, 2.0 L	2004	-	2004



**38011**

CHEVROLET	CAPTIVA	4 CIL, 2.4 L	2008	-	2008
CHEVROLET	CAPTIVA	4 CIL, 2.4 L	2009	-	2010
CHEVROLET	CAVALIER	4 CIL, 2.2 L	1998	-	2004
CHEVROLET	CAVALIER	4 CIL, 2.2 L	2005	-	2005
CHEVROLET	CAVALIER	4 CIL, 2.3 L	1995	-	1995
CHEVROLET	CAVALIER	4 CIL, 2.4 L	1996	-	1998
CHEVROLET	CLASSIC	4 CIL, 2.2 L	2005	-	2005
CHEVROLET	COBALT	4 CIL, 2.2 L	2005	-	2007
CHEVROLET	COBALT	4 CIL, 2.4 L	2006	-	2007
CHEVROLET	HHR	4 CIL, 2.4 L	2006	-	2007
CHEVROLET	MALIBU	4 CIL, 2.2 L	2004	-	2007
CHEVROLET	MALIBU	4 CIL, 2.4 L	1997	-	1998
PONTIAC	G4	4 CIL, 2.2 L	2006	-	2006
PONTIAC	G4	4 CIL, 2.4 L	2006	-	2006
PONTIAC	G5	4 CIL, 2.2 L	2007	-	2008
PONTIAC	G5	4 CIL, 2.4 L	2007	-	2008
PONTIAC	G6	4 CIL, 2.4 L	2006	-	2007
PONTIAC	GRAND AM	4 CIL, 2.2 L	2002	-	2003
PONTIAC	GRAND AM	4 CIL, 2.3 L	1995	-	1995
PONTIAC	GRAND AM	4 CIL, 2.4 L	1996	-	1997
PONTIAC	GRAND AM	4 CIL, 2.4 L	1999	-	1999
PONTIAC	SOLSTICE	4 CIL, 2.0 L	2007	-	2007
PONTIAC	SOLSTICE	4 CIL, 2.4 L	2006	-	2008
PONTIAC	SUNFIRE	4 CIL, 2.2 L	1998	-	2004
PONTIAC	SUNFIRE	4 CIL, 2.2 L	2005	-	2005
PONTIAC	SUNFIRE	4 CIL, 2.3 L	1995	-	1995
PONTIAC	SUNFIRE	4 CIL, 2.4 L	1996	-	1998
SAAB	9 - 3	4 CIL, 2.0 L	2003	-	2006
SATURN	ION	4 CIL, 2.2 L	2003	-	2007
SATURN	ION	4 CIL, 2.4 L	2006	-	2007
SATURN	L-SERIES	4 CIL, 2.2 L	2000	-	2004
SATURN	SKY	4 CIL, 2.4 L	2007	-	2007
SATURN	VUE	4 CIL, 2.2 L	2002	-	2007



**38012**

FORD	F SERIES PICKUP	6 CIL, 4.9 L	1996	-	1996
------	-----------------	--------------	------	---	------



### 38015

AUDI	A4	V-6, 3.2 L	2005	-	2005
AUDI	A4	V-6, 3.2 L	2006	-	2007
AUDI	A4	V-6, 3.2 L	2008	-	2009
AUDI	A6	V-6, 3.0 L	2005	-	2006
AUDI	A6	V-6, 3.2 L	2005	-	2005
AUDI	A6	V-6, 3.2 L	2006	-	2007
AUDI	A6	V-6, 3.2 L	2008	-	2008
AUDI	A6 QUATTRO	V-6, 3.2 L	2005	-	2005
AUDI	A6 QUATTRO	V-6, 3.2 L	2006	-	2006
CADILLAC	REGAL	V-6, 3.8 L	1996	-	1996
CHEVROLET	AVEO	4 CIL, 1.6 L	2008	-	2008
CHEVROLET	AVEO	4 CIL, 1.6 L	2009	-	2009
CHEVROLET	CAMARO	V-6, 3.8 L	1995	-	1997
CHEVROLET	CAVALIER	4 CIL, 2.2 L	1998	-	2002
CHEVROLET	CORVETTE	V-8, 5.7 L	1991	-	1992
CHEVROLET	CORVETTE	V-8, 5.7 L	1993	-	1996
CHEVROLET	EIGHTY EIGHT	V-6, 3.8 L	1995	-	1995
CHEVROLET	LUMINA	V-6, 3.8 L	1998	-	1998
CHEVROLET	REGAL	V-6, 3.8 L	1996	-	1996
CHEVROLET	S SERIES PICKUP	4 CIL, 2.2 L	1998	-	2003
CHEVROLET	S-10	4 CIL, 2.2 L	1998	-	2003
DODGE	RAM 1500	V-6, 3.7 L	2006	-	2007
DODGE	RAM 2500	V-8, 4.7 L	2004	-	2007
FORD	AEROSTAR	V-6, 3.0 L	1990	-	1992
FORD	AEROSTAR	V-6, 3.0 L	1993	-	1997
FORD	BRONCO	V-8, 5.0 L	1994	-	1996
FORD	E SERIES VAN	V-8, 5.0 L	1996	-	1996
FORD	E SERIES VAN	V-8, 5.8 L	1996	-	1996
FORD	F SERIES PICKUP	V-8, 5.0 L	1990	-	1994
FORD	F SERIES PICKUP	V-8, 5.0 L	1995	-	1996
FORD	F SERIES PICKUP	V-8, 5.8 L	1994	-	1994
FORD	F SERIES PICKUP	V-8, 5.8 L	1995	-	1996
FORD	F SERIES PICKUP	V-8, 7.3 L	1994	-	1994
FORD	F-200	V-8, 5.0 L	1990	-	1991
FORD	F-250	V-8, 5.0 L	1992	-	1992
FORD	F-250	V-8, 5.0 L	1993	-	1996
FORD	F-350 SUPER DUTY	V-8, 5.0 L	1990	-	1992
FORD	F-350 SUPER DUTY	V-8, 5.0 L	1993	-	1996
FORD	SUPER DUTY PICKUP	V-8, 7.3 L	1994	-	1994
GMC	SONOMA	4 CIL, 2.2 L	2000	-	2003
JEEP	LIBERTY	V-6, 3.7 L	2008	-	2009
OLDSMOBILE	EIGHTY EIGHT	V-6, 3.8 L	1995	-	1997
OLDSMOBILE	EIGHTY EIGHT	V-6, 3.8 L	1998	-	1998
OLDSMOBILE	LSS	V-6, 3.8 L	1997	-	1998
OLDSMOBILE	NINETY EIGHT	V-6, 3.8 L	1995	-	1996
OLDSMOBILE	REGENCY	V-6, 3.8 L	1997	-	1998
PONTIAC	BONNEVILLE	V-6, 3.8 L	1994	-	1998
PONTIAC	FIREBIRD	V-6, 3.8 L	1995	-	1997
PONTIAC	G3	4 CIL, 1.6 L	2006	-	2008
PONTIAC	GRAND PRIX	V-6, 3.8 L	1997	-	1998
PONTIAC	SUNFIRE	4 CIL, 2.2 L	1998	-	2002
PONTIAC	G3	4 CIL, 1.6 L	2006	-	2007
SUZUKI	SWIFT	4 CIL, 1.6 L	2004	-	2005
SUZUKI	SWIFT	4 CIL, 1.6 L	2006	-	2007
SUZUKI	SWIFT	4 CIL, 1.6 L	2008	-	2008



### 38016

DODGE	B SERIES VAN	V-6, 3.9 L	1995	-	2003
DODGE	B SERIES VAN	V-8, 5.2 L	1995	-	2003
DODGE	B SERIES VAN	V-8, 5.9 L	1995	-	2003
DODGE	D-150	V-6, 3.9 L	1992	-	1992
DODGE	D-150	V-6, 3.9 L	1993	-	1993
DODGE	D-250	V-8, 5.9 L	1992	-	1992
DODGE	D-250	V-8, 5.9 L	1993	-	1993
DODGE	D-350	V-8, 5.9 L	1992	-	1992
DODGE	D-350	V-8, 5.9 L	1993	-	1993
DODGE	DAKOTA	V-6, 3.9 L	1995	-	2003
DODGE	DAKOTA	V-8, 5.2 L	1995	-	1999
DODGE	DAKOTA	V-8, 5.9 L	1998	-	2003
DODGE	DURANGO	V-6, 3.9 L	1998	-	1999
DODGE	DURANGO	V-8, 5.2 L	1998	-	2000
DODGE	DURANGO	V-8, 5.9 L	1998	-	2003
DODGE	RAM 1500	V-6, 3.9 L	1994	-	2001
DODGE	RAM 2500	V-8, 5.2 L	1997	-	2001
DODGE	RAM 2500	V-8, 5.9 L	1994	-	2002
DODGE	RAM 2500 4 X 4	V-8, 5.9 L	2002	-	2002
DODGE	RAM 3500	V-8, 5.9 L	1994	-	2002
DODGE	RAM 4000	V-8, 5.9 L	1995	-	2002
DODGE	RAM CHARGER	V-8, 5.9 L	1992	-	1992
DODGE	RAM CHARGER	V-8, 5.9 L	1993	-	1993
DODGE	RAM MAXI VAN 1500	V-6, 3.9 L	1999	-	2002
DODGE	RAM MAXI VAN 2500	V-8, 5.2 L	1996	-	2002
DODGE	RAM MAXI VAN 3500	V-8, 5.9 L	1996	-	2002
DODGE	RAM MAXI WAGON 3500	V-8, 5.2 L	1996	-	1996
DODGE	RAM MAXI WAGON 3500	V-8, 5.9 L	1996	-	2002
DODGE	RAM SERIES PICKUP	V-6, 3.9 L	1994	-	2001
DODGE	RAM SERIES PICKUP	V-8, 5.2 L	1995	-	2001
DODGE	RAM SERIES PICKUP	V-8, 5.9 L	1994	-	2002
DODGE	RAM SERIES PICKUP	V-8, 5.9 L	2003	-	2003
DODGE	RAM VAN 1500	V-6, 3.9 L	1995	-	2002
DODGE	RAM VAN 2500	V-8, 5.2 L	2002	-	2002
DODGE	RAM VAN 3500	V-8, 5.9 L	1996	-	2002
DODGE	RAM W2500	V-8, 5.9 L	1995	-	1998
DODGE	RAM WAGON 1500	V-8, 5.2 L	1997	-	2001
DODGE	RAM WAGON 2500	V-8, 5.2 L	1997	-	2001
DODGE	RAM WAGON 2500	V-8, 5.9 L	1994	-	1995
DODGE	RAM WAGON 3500	V-8, 5.9 L	2002	-	2002
JEEP	GRAND CHEROKEE	V-8, 5.2 L	1995	-	1998
JEEP	GRAND CHEROKEE	V-8, 5.9 L	1998	-	1998



### 38017

CHEVROLET	ASTRO	V-6, 4.3 L	1989	-	1989
CHEVROLET	C y K SERIES PICKUP	V-6, 4.3 L	1989	-	1989
CHEVROLET	C y K SERIES PICKUP	V-8, 5.0 L	1989	-	1989
CHEVROLET	C y K SERIES PICKUP	V-8, 5.7 L	1988	-	1989
CHEVROLET	G SERIES VAN	V-6, 4.3 L	1989	-	1991
CHEVROLET	G SERIES VAN	V-8, 5.0 L	1989	-	1991
CHEVROLET	G SERIES VAN	V-8, 5.7 L	1989	-	1991



### 38018

AUDI	A3	4 CIL, 2.0 L	2006	-	2007
AUDI	A3	4 CIL, 2.0 L	2008	-	2008
AUDI	TT	4 CIL, 1.8 L	2000	-	2001
AUDI	TT	4 CIL, 1.8 L	2002	-	2006
BMW	325XI	6 CIL, 2.5 L	2005	-	2005
BMW	325XI	V-6, 2.5 L	2001	-	2001



BMW	328XI	6 CIL, 2.5 L	2005	-	2005
BMW	330XI	6 CIL, 3.0 L	2005	-	2006
BMW	530I	6 CIL, 3.0 L	2002	-	2002
BMW	545I	V-8, 4.4 L	2005	-	2005
BMW	X3	6 CIL, 3.0 L	2005	-	2005
BMW	X3	6 CIL, 3.0 L	2006	-	2006
BMW	X3	V-6, 3.0 L	2007	-	2008
BMW	X5	6 CIL, 3.0 L	2001	-	2001
BMW	X5	6 CIL, 3.0 L	2005	-	2005
BMW	X5	6 CIL, 3.0 L	2006	-	2006
BMW	X5	V-6, 3.0 L	2009	-	2009
BMW	X5	V-8, 4.4 L	2000	-	2000
BMW	X5	V-8, 4.4 L	2001	-	2001
BMW	X5	V-8, 4.4 L	2002	-	2003
BMW	X5	V-8, 4.6 L	2002	-	2002
BMW	X5	V-8, 4.6 L	2003	-	2003
CHEVROLET	COLORADO	4 CIL, 2.8 L	2005	-	2005
CHEVROLET	COLORADO	4 CIL, 2.8 L	2006	-	2006
CHEVROLET	COLORADO	5 CIL, 3.5 L	2004	-	2004
CHEVROLET	COLORADO	5 CIL, 3.5 L	2005	-	2006
CHEVROLET	EPICA	6 CIL, 2.5 L	2004	-	2006
CHEVROLET	TRAILBLAZER	6 CIL, 4.2 L	2002	-	2007
CHEVROLET	TRAILBLAZER	6 CIL, 4.2 L	2005	-	2005
CHRYSLER	300 C	V-8, 5.7 L	2007	-	2009
CHRYSLER	TOWN & COUNTRY	V-6, 3.8 L	2005	-	2007
CHRYSLER	TOWN & COUNTRY	V-6, 4.0 L	2008	-	2010
CHRYSLER	TOWN & COUNTRY VAN	V-6, 3.3 L	2001	-	2006
CHRYSLER	TOWN & COUNTRY VAN	V-6, 3.8 L	2001	-	2006
CHRYSLER	VOYAGER	V-6, 3.3 L	2001	-	2007
DODGE	CARAVAN	V-6, 3.3 L	2001	-	2003
DODGE	CARAVAN	V-6, 3.3 L	2002	-	2007
DODGE	CHARGER	V-8, 5.7 L	2007	-	2008
DODGE	CHARGER	V-8, 5.7 L	2009	-	2009
DODGE	CHARGER	V-8, 6.1 L	2006	-	2006
DODGE	CHARGER	V-8, 6.1 L	2007	-	2008
DODGE	DURANGO	V-8, 5.7 L	2008	-	2009
DODGE	GRAND CARAVAN	V-6, 3.3 L	2001	-	2006
DODGE	GRAND CARAVAN	V-6, 3.8 L	2001	-	2006
DODGE	JOURNEY	V-6, 3.5 L	2010	-	2009
DODGE	NITRO	V-6, 4.0 L	2007	-	2008
DODGE	NITRO	V-6, 4.0 L	2009	-	2010
DODGE	RAM 2500	V-8, 5.7 L	2009	-	2009
FORD	CONTOUR	4 CIL, 2.0 L	1998	-	2000
FORD	COUGAR	V-6, 2.5 L	2002	-	2002
FORD	ESCAPE	4 CIL, 2.0 L	2001	-	2002
FORD	ESCAPE	4 CIL, 2.0 L	2003	-	2004
FORD	FOCUS	4 CIL, 2.0 L	2000	-	2002
JEEP	COMMANDER	V-8, 5.7 L	2006	-	2008
JEEP	COMMANDER	V-8, 5.7 L	2009	-	2009
JEEP	GRAND CHEROKEE	6 CIL, 4.0 L	1999	-	2002
JEEP	GRAND CHEROKEE	6 CIL, 4.0 L	2003	-	2004
JEEP	GRAND CHEROKEE	V-6, 4.0 L	2003	-	2003
JEEP	GRAND CHEROKEE	V-8, 5.7 L	2005	-	2007
JEEP	GRAND CHEROKEE	V-8, 5.7 L	2008	-	2009
JEEP	GRAND CHEROKEE	V-8, 6.1 L	2006	-	2007
JEEP	LIBERTY	4 CIL, 2.4 L	2002	-	2005
JEEP	WRANGLER	4 CIL, 2.4 L	2003	-	2006
JEEP	WRANGLER	6 CIL, 4.0 L	2000	-	2006
JEEP	WRANGLER	6 CIL, 4.0 L	2004	-	2004
JEEP	WRANGLER	V-6, 3.8 L	2008	-	2010
MERCURY	MYSTIQUE	4 CIL, 2.0 L	1998	-	2000
SUZUKI	VERONA	6 CIL, 2.5 L	2004	-	2006
TOYOTA	CAMRY	4 CIL, 2.5 L	2010	-	2011
TOYOTA	CELICA	4 CIL, 1.8 L	2000	-	2005
TOYOTA	COROLLA	4 CIL, 1.8 L	2000	-	2001
TOYOTA	COROLLA	4 CIL, 1.8 L	2002	-	2008
TOYOTA	MATRIX	4 CIL, 1.8 L	2003	-	2008
TOYOTA	MR2 SPYDER	4 CIL, 1.8 L	2000	-	2005
VOLKSWAGEN	BEETLE	4 CIL, 1.8 L	1998	-	1998
VOLKSWAGEN	BEETLE	4 CIL, 1.8 L	1999	-	2005
VOLKSWAGEN	BEETLE	4 CIL, 1.9 L	2004	-	2005
VOLKSWAGEN	BEETLE	4 CIL, 2.0 L	1998	-	2008
VOLKSWAGEN	BORA	4 CIL, 1.9 L DIESE	2007	-	2007
VOLKSWAGEN	GOLF	4 CIL, 1.8 L	2000	-	2006
VOLKSWAGEN	GOLF	4 CIL, 1.8 L	2002	-	2002
VOLKSWAGEN	GOLF	4 CIL, 1.9 L	2004	-	2005
VOLKSWAGEN	GOLF	4 CIL, 2.0 L	1999	-	2006
VOLKSWAGEN	JETTA	4 CIL, 1.8 L	2000	-	2006

VOLKSWAGEN	JETTA	4 CIL, 1.9 L	2004	-	2006
VOLKSWAGEN	JETTA	4 CIL, 1.9 L DIESE	2004	-	2007
VOLKSWAGEN	JETTA	4 CIL, 2.0 L	1999	-	2008
VOLKSWAGEN	JETTA	4 CIL, 2.0 L	2009	-	2010
VOLKSWAGEN	PASSAT	4 CIL, 2.0 L	2006	-	2008
VOLKSWAGEN	ROUTAN	V-6, 3.8 L	2009	-	2010
VOLVO	C70	5 CIL, 2.3 L	2000	-	2004
VOLVO	C70	5 CIL, 2.4 L	2000	-	2004
VOLVO	S40	4 CIL, 1.9 L	2000	-	2004
VOLVO	S60	5 CIL, 2.3 L	2001	-	2001
VOLVO	S60	5 CIL, 2.3 L	2002	-	2004
VOLVO	S60	5 CIL, 2.4 L	2001	-	2006
VOLVO	S60	5 CIL, 2.4 L	2002	-	2007
VOLVO	S60	5 CIL, 2.5 L	2003	-	2007
VOLVO	S60	5 CIL, 2.5 L	2004	-	2006
VOLVO	S70	5 CIL, 2.3 L	2000	-	2000
VOLVO	S70	5 CIL, 2.4 L	2000	-	2000
VOLVO	S80	5 CIL, 2.5 L	2004	-	2004
VOLVO	S80	5 CIL, 2.5 L	2005	-	2006
VOLVO	S80	6 CIL, 2.8 L	2000	-	2001
VOLVO	S80	6 CIL, 2.9 L	2000	-	2005

**38019**



CHEVROLET	C y K SERIES PICKUP	V-8, 7.4 L	1989	-	1995
CHEVROLET	G SERIES VAN	V-8, 7.4 L	1989	-	1991
CHEVROLET	SUBURBAN	V-8, 7.4 L	1989	-	1992
CHEVROLET	SUBURBAN	V-8, 7.4 L	1993	-	1995
JEEP	CHEROKEE	6 CIL, 4.0 L	1996	-	2001
JEEP	WRANGLER	4 CIL, 2.5 L	1997	-	1998
JEEP	WRANGLER	6 CIL, 4.0 L	1997	-	1998

**38020**



CADILLAC	DEVILLE	V-8, 4.9 L	1991	-	1992
CADILLAC	DEVILLE	V-8, 4.9 L	1993	-	1993
CHEVROLET	BLAZER COMPACT	V-6, 2.8 L	1989	-	1989
CHEVROLET	C y K SERIES PICKUP	V-8, 6.5 L	1999	-	2002
CHEVROLET	EXPRESS	V-8, 6.5 L	1999	-	2002
CHEVROLET	S SERIES PICKUP	V-6, 2.8 L	1989	-	1993
CHRYSLER	300M	V-6, 3.5 L	1999	-	2000
CHRYSLER	CIRRUS	4 CIL, 2.0 L	2000	-	2000
CHRYSLER	CIRRUS	4 CIL, 2.4 L	1997	-	2000
CHRYSLER	CIRRUS	4 CIL, 2.4 L	1998	-	1998
CHRYSLER	CIRRUS	V-6, 2.5 L	1996	-	2000
CHRYSLER	CONCORDE	V-6, 3.2 L	1999	-	2001
CHRYSLER	CONCORDE	V-6, 3.5 L	1993	-	1997
CHRYSLER	GRAND VOYAGER	V-6, 3.3 L	1991	-	1993
CHRYSLER	GRAND VOYAGER	V-6, 3.8 L	1994	-	1999
CHRYSLER	NEW YORKER	V-6, 3.3 L	1992	-	1992
CHRYSLER	NEW YORKER	V-6, 3.3 L	1993	-	1993
CHRYSLER	SEBRING	4 CIL, 2.4 L	1996	-	1996
CHRYSLER	SEBRING	4 CIL, 2.4 L	1997	-	1997
CHRYSLER	VOYAGER	V-6, 3.3 L	1994	-	1995
CHRYSLER	VOYAGER	V-6, 3.3 L	1996	-	2000
CHRYSLER	VOYAGER TOWN N COUNTRY	V-6, 3.8 L	1995	-	2000
DODGE	INTREPID	V-6, 3.2 L	1998	-	2000
DODGE	INTREPID	V-6, 3.5 L	1994	-	2000
DODGE	STRATUS	4 CIL, 2.0 L	1996	-	2000
DODGE	STRATUS	4 CIL, 2.4 L	1995	-	2000
DODGE	STRATUS	V-6, 2.5 L	1999	-	2000



GMC	C y K SERIES PICKUP	V-8, 6.5 L	2000	-	2002
GMC	SAVANA	V-8, 6.5 L	2000	-	2002
JEEP	CHEROKEE	6 CIL, 4.0 L	1994	-	1994
JEEP	CHEROKEE	6 CIL, 4.0 L	1995	-	2000
JEEP	GRAND CHEROKEE	6 CIL, 4.0 L	1996	-	1999
JEEP	WRANGLER	4 CIL, 2.5 L	1995	-	2002

### 38022



FORD	E SERIES VAN	6 CIL, 4.9 L	1994	-	1994
FORD	E SERIES VAN	6 CIL, 4.9 L	1995	-	1996
FORD	E SERIES VAN	V-10, 6.8 L	1997	-	1998
FORD	E SERIES VAN	V-8, 4.6 L	1997	-	1998
FORD	E SERIES VAN	V-8, 4.6 L	1999	-	2001
FORD	E SERIES VAN	V-8, 5.4 L	1997	-	2002
FORD	E SERIES VAN	V-8, 7.3 L	1996	-	1996
FORD	E SERIES VAN	V-8, 7.3 L	1997	-	1997
FORD	EXCURSION	V-10, 6.8 L	2000	-	2005
FORD	EXCURSION	V-8, 5.4 L	2001	-	2001
FORD	EXCURSION	V-8, 5.4 L	2003	-	2003
FORD	EXPEDITION	V-8, 4.6 L	1997	-	2002
FORD	EXPEDITION	V-8, 5.4 L	1997	-	2002
FORD	EXPLORER	V-8, 4.6 L	2002	-	2003
FORD	F SERIES PICKUP	6 CIL, 4.9 L	1994	-	1996
FORD	F SERIES PICKUP	V-10, 6.8 L	1999	-	2000
FORD	F SERIES PICKUP	V-10, 6.8 L	2001	-	2001
FORD	F SERIES PICKUP	V-6, 4.9 L	1995	-	1996
FORD	F SERIES PICKUP	V-8, 4.6 L	1997	-	1997
FORD	F SERIES PICKUP	V-8, 4.6 L	1998	-	2001
FORD	F SERIES PICKUP	V-8, 5.4 L	1997	-	2003
FORD	F SERIES PICKUP	V-8, 5.4 L	1999	-	2002
FORD	F SERIES PICKUP	V-8, 7.3 L	1995	-	1997
FORD	F-150	V-6, 4.9 L	1995	-	1996
FORD	F-250	V-8, 4.6 L	1998	-	2004
FORD	F-250 LOBO	V-8, 5.4 L	1999	-	2001
FORD	F-350 SUPER DUTY	V-8, 5.4 L	1999	-	2006
FORD	F-450 SUPER DUTY	V-10, 6.8 L	1999	-	2006
FORD	LOBO	V-8, 5.4 L	2002	-	2002
FORD	MUSTANG	V-6, 3.8 L	1994	-	1995
FORD	MUSTANG	V-6, 3.8 L	1996	-	1998
FORD	SERIES F SUPER DUTY	V-10, 6.8 L	2002	-	2002
FORD	SERIES F SUPER DUTY	V-8, 5.4 L	2002	-	2002
FORD	SUPER DUTY PICKUP	V-10, 6.8 L	1999	-	2002
FORD	SUPER DUTY PICKUP	V-10, 6.8 L	2001	-	2001
FORD	SUPER DUTY PICKUP	V-8, 5.4 L	1999	-	2002
FORD	SUPER DUTY PICKUP	V-8, 6.0 L	2003	-	2003
FORD	SUPER DUTY PICKUP	V-8, 7.3 L	1995	-	1997
FORD	SUPER DUTY VAN	V-10, 6.8 L	1997	-	1998
FORD	SUPER DUTY VAN	V-10, 6.8 L	1999	-	2001
FORD	SUPER DUTY VAN	V-8, 4.6 L	2003	-	2003
FORD	SUPER DUTY VAN	V-8, 4.6 L CNG	2003	-	2003
FORD	SUPER DUTY VAN	V-8, 5.4 L	1997	-	1997
FORD	SUPER DUTY VAN	V-8, 5.4 L	1999	-	2001
FORD	SUPER DUTY VAN	V-8, 7.3 L	1996	-	1997
LINCOLN	NAVIGATOR	V-8, 5.4 L	1998	-	2002

### 38023

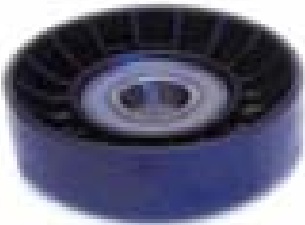

FORD	E SERIES VAN	V-10, 6.8 L	1997	-	1998
FORD	E SERIES VAN	V-8, 4.6 L	1997	-	1998
FORD	E SERIES VAN	V-8, 4.6 L	1999	-	2001

FORD	E SERIES VAN	V-8, 5.4 L	1997	-	2002
FORD	EXCURSION	V-10, 6.8 L	2000	-	2003
FORD	EXCURSION	V-8, 5.4 L	2000	-	2001
FORD	EXPEDITION	V-8, 4.6 L	1997	-	2002
FORD	EXPEDITION	V-8, 5.4 L	1997	-	2002
FORD	F SERIES PICKUP	V-10, 6.8 L	1999	-	2000
FORD	F SERIES PICKUP	V-10, 6.8 L	2001	-	2001
FORD	F SERIES PICKUP	V-8, 4.6 L	1997	-	1997
FORD	F SERIES PICKUP	V-8, 4.6 L	1998	-	2001
FORD	F SERIES PICKUP	V-8, 5.4 L	1997	-	1998
FORD	F SERIES PICKUP	V-8, 5.4 L	1999	-	2002
FORD	F-250	V-8, 4.6 L	1998	-	2004
FORD	F-250 LOBO	V-8, 5.4 L	1999	-	2001
FORD	F-350 SUPER DUTY	V-8, 5.4 L	1999	-	2006
FORD	F-450 SUPER DUTY	V-10, 6.8 L	1999	-	2006
FORD	LOBO	V-8, 5.4 L	2002	-	2002
FORD	SERIES F SUPER DUTY	V-10, 6.8 L	2002	-	2002
FORD	SERIES F SUPER DUTY	V-8, 5.4 L	2002	-	2002
FORD	SERIES F SUPER DUTY	V-8, 7.3 L	2002	-	2002
FORD	SUPER DUTY PICKUP	V-10, 6.8 L	1999	-	2002
FORD	SUPER DUTY PICKUP	V-10, 6.8 L	2001	-	2001
FORD	SUPER DUTY PICKUP	V-8, 5.4 L	1999	-	2002
FORD	SUPER DUTY PICKUP	V-8, 7.3 L	1999	-	2002
FORD	SUPER DUTY VAN	V-10, 6.8 L	1997	-	1998
FORD	SUPER DUTY VAN	V-10, 6.8 L	1999	-	2001
FORD	SUPER DUTY VAN	V-8, 5.4 L	1997	-	1997
FORD	SUPER DUTY VAN	V-8, 5.4 L	1999	-	2001
FORD	SUPER DUTY VAN	V-8, 7.3 L	1999	-	2001
FORD	THUNDERBIRD	V-6, 3.8 L	1990	-	1995
FORD	THUNDERBIRD	V-6, 3.8 L	1994	-	1994
FORD	WINDSTAR	V-6, 3.8 L	1995	-	1995
LINCOLN	NAVIGATOR	V-8, 5.4 L	1998	-	2002
MERCURY	SABLE / TAURUS	V-6, 3.8 L	1991	-	1992
MERCURY	SABLE / TAURUS	V-6, 3.8 L	1995	-	1995

### 38024

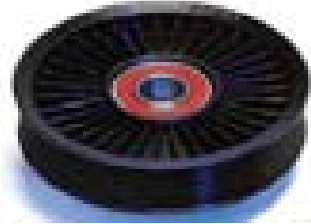

CHEVROLET	AVEO	4 CIL, 1.6 L	2008	-	2008
CHEVROLET	AVEO	4 CIL, 1.6 L	2009	-	2009
CHEVROLET	BLAZER	V-6, 4.3 L	1993	-	1995
CHEVROLET	BLAZER COMPACT	V-6, 4.3 L	1989	-	1994
CHEVROLET	BLAZER FULL SIZE	V-8, 5.7 L	1989	-	1994
CHEVROLET	C y K SERIES PICKUP	V-6, 4.3 L	1990	-	1994
CHEVROLET	C y K SERIES PICKUP	V-6, 4.3 L	1995	-	1995
CHEVROLET	C y K SERIES PICKUP	V-8, 5.0 L	1990	-	1995
CHEVROLET	C y K SERIES PICKUP	V-8, 5.7 L	1990	-	1992
CHEVROLET	C y K SERIES PICKUP	V-8, 5.7 L	1993	-	1995
CHEVROLET	C-20	V-8, 5.7 L	1990	-	1991
CHEVROLET	C-2500	V-8, 5.7 L	1992	-	1992
CHEVROLET	C-2500	V-8, 5.7 L	1993	-	1995
CHEVROLET	C-30	V-8, 5.7 L	1990	-	1993
CHEVROLET	C-35	V-8, 5.7 L	1990	-	1992
CHEVROLET	C-35	V-8, 5.7 L	1993	-	1993
CHEVROLET	C-3500	V-8, 5.7 L	1994	-	1995
CHEVROLET	S SERIES PICKUP	V-6, 4.3 L	1989	-	1995
CHEVROLET	S-10	V-6, 4.3 L	1994	-	1995
CHEVROLET	SUBURBAN	V-8, 5.7 L	1990	-	1992
CHEVROLET	SUBURBAN	V-8, 5.7 L	1993	-	1995
CHEVROLET	TAHOE	V-8, 5.7 L	1995	-	1995
PONTIAC	G3	4 CIL, 1.6 L	2006	-	2008
POTIAC	G3	4 CIL, 1.6 L	2006	-	2007
SUZUKI	SWIFT	4 CIL, 1.6 L	2004	-	2005
SUZUKI	SWIFT	4 CIL, 1.6 L	2006	-	2007
SUZUKI	SWIFT	4 CIL, 1.6 L	2008	-	2008



### 38025

CADILLAC	DEVILLE	V-8, 4.6 L	1998	-	2005
CADILLAC	DTS	V-8, 4.6 L	2006	-	2007
CADILLAC	EL DORADO	V-8, 4.6 L	1995	-	1997
CADILLAC	EL DORADO	V-8, 4.6 L	1998	-	2002
CADILLAC	SEVILLE	V-8, 4.6 L	1995	-	2004
TOYOTA	CAMRY	4 CIL, 2.5 L	2010	-	2011



### 38029

FORD	MUSTANG	V-6, 3.8 L	1994	-	1995
FORD	MUSTANG	V-6, 3.8 L	1996	-	2000

### 38030



### 38026

CHEVROLET	CAVALIER	4 CIL, 2.0 L	1989	-	1989
CHEVROLET	CAVALIER	4 CIL, 2.2 L	1990	-	1992
CHEVROLET	CAVALIER	4 CIL, 2.2 L	1993	-	1997
PONTIAC	SUNFIRE	4 CIL, 2.2 L	1995	-	1997
SATURN	S-SERIES	4 CIL, 1.9 L	1991	-	2002

ACURA	INTEGRA	4 CIL, 1.8 L	1999	-	1999
HONDA	CIVIC	4 CIL, 1.5 L	1995	-	1995
HONDA	CIVIC	4 CIL, 1.6 L	1996	-	1996
HONDA	CIVIC	4 CIL, 1.6 L	1997	-	1999
HONDA	CIVIC DEL SOL	4 CIL, 1.5 L	1995	-	1995
HONDA	CIVIC DEL SOL	4 CIL, 1.6 L	1995	-	1997
HONDA	CR-V	4 CIL, 2.0 L	1997	-	1998
HONDA	CR-V	4 CIL, 2.0 L	1999	-	2001
SUBARU	FORESTER	4 CIL, 2.5 L	2004	-	2005
SUBARU	FORESTER	4 CIL, 2.5 L	2006	-	2006
SUBARU	FORESTER	4 CIL, 2.5 L	2007	-	2007
SUBARU	IMPREZA	4 CIL, 2.0 L	2004	-	2005
SUBARU	IMPREZA	4 CIL, 2.5 L	2004	-	2005
SUBARU	IMPREZA	4 CIL, 2.5 L	2006	-	2007
SUBARU	LEGACY	4 CIL, 2.5 L	2004	-	2005
SUBARU	LEGACY	4 CIL, 2.5 L	2006	-	2007
SUBARU	OUTBACK	4 CIL, 2.5 L	2004	-	2005
SUBARU	OUTBACK	4 CIL, 2.5 L	2006	-	2006

### 38027



CADILLAC	REGAL	V-6, 3.8 L	1994	-	1995
CHEVROLET	EIGHTY EIGHT	V-6, 3.8 L	1992	-	1994
CHEVROLET	LUMINA	V-6, 3.4 L	1991	-	1992
CHEVROLET	LUMINA	V-6, 3.4 L	1993	-	1995
CHEVROLET	LUMINA	V-6, 3.4 L	1996	-	1997
CHEVROLET	LUMINA APV	V-6, 3.8 L	1992	-	1995
CHEVROLET	REGAL	V-6, 3.8 L	1994	-	1995
OLDSMOBILE	SILHOUETTE	V-6, 3.8 L	1994	-	1995
PONTIAC	GRAND PRIX	V-6, 3.4 L	1995	-	1996
PONTIAC	TRANS SPORT	V-6, 3.8 L	1995	-	1995

### 38028



FORD	E SERIES VAN	V-8, 7.3 L	1998	-	1998
FORD	EXCURSION	V-8, 7.3 L	2000	-	2003
FORD	F-450 SUPER DUTY	V-8, 7.3 L	2002	-	2003
FORD	SUPER DUTY PICKUP	V-8, 7.3 L	1999	-	2002
FORD	SUPER DUTY PICKUP	V-8, 7.3 L	2003	-	2003
FORD	SUPER DUTY VAN	V-8, 7.3 L	1998	-	2003
FORD	SUPER DUTY VAN	V-8, 7.3 L	1999	-	2001



### 38031

TOYOTA	4 RUNNER	4 CIL, 2.7 L	2000	-	2000
TOYOTA	4 RUNNER	V-6, 3.4 L	2000	-	2001
TOYOTA	4 RUNNER	V-6, 3.4 L	2002	-	2002
TOYOTA	TACOMA	4 CIL, 2.4 L	2000	-	2004
TOYOTA	TACOMA	4 CIL, 2.7 L	2000	-	2004
TOYOTA	TACOMA	V-6, 3.4 L	2000	-	2004
TOYOTA	TUNDRA	V-6, 3.4 L	2000	-	2004

### 38032



CHEVROLET	CAVALIER	4 CIL, 2.4 L	1999	-	1999
CHEVROLET	CAVALIER	4 CIL, 2.4 L	2000	-	2002
CHEVROLET	CAVALIER Z24	4 CIL, 2.4 L	1998	-	2002
CHEVROLET	MALIBU	4 CIL, 2.4 L	1999	-	1999
FORD	TOPAZ	4 CIL, 2.3 L	1994	-	1994
PONTIAC	SUNFIRE	4 CIL, 2.4 L	1999	-	2002



SATURN S-SERIES 4 CIL, 1.9 L 2000 - 2002



**38033**

CHEVROLET P SERIES VAN V-8, 5.7 L 1989 - 1996  
 NISSAN FRONTIER 4 CIL, 2.4 L 1998 - 1998  
 NISSAN FRONTIER 4 CIL, 2.4 L 1999 - 2004  
 NISSAN XTERRA 4 CIL, 2.4 L 2000 - 2004

**38038**



FORD BRONCO V-8, 5.8 L 1995 - 1995  
 FORD E SERIES VAN V-8, 5.0 L 1994 - 1996  
 FORD E SERIES VAN V-8, 5.8 L 1994 - 1994  
 FORD F SERIES PICKUP V-8, 5.0 L 1994 - 1994  
 FORD F SERIES PICKUP V-8, 5.8 L 1994 - 1994

**38040**



DODGE B SERIES VAN V-6, 3.9 L 1995 - 2003  
 DODGE B SERIES VAN V-8, 5.2 L 1995 - 2003  
 DODGE B SERIES VAN V-8, 5.9 L 1995 - 2003  
 DODGE DAKOTA V-6, 3.9 L 1995 - 2003  
 DODGE DAKOTA V-8, 5.2 L 1995 - 1999  
 DODGE DAKOTA V-8, 5.9 L 1998 - 2003  
 DODGE DURANGO V-6, 3.9 L 1998 - 1999  
 DODGE DURANGO V-8, 5.2 L 1998 - 2000  
 DODGE DURANGO V-8, 5.9 L 1998 - 2003  
 DODGE RAM SERIES PICKUP V-10, 8.0 L 1995 - 1998  
 DODGE RAM SERIES PICKUP V-10, 8.0 L 1999 - 2003  
 DODGE RAM SERIES PICKUP V-6, 3.9 L 1995 - 2001  
 DODGE RAM SERIES PICKUP V-8, 5.2 L 1995 - 2001  
 DODGE RAM SERIES PICKUP V-8, 5.9 L 1995 - 2002  
 DODGE VIPER V-10, 8.0 L 1995 - 1997  
 DODGE VIPER V-10, 8.0 L 1998 - 2002  
 JEEP GRAND CHEROKEE V-8, 5.2 L 1995 - 1998  
 JEEP GRAND CHEROKEE V-8, 5.9 L 1998 - 1998

**38034**



CHRYSLER 300M V-6, 3.5 L 1999 - 2004  
 CHRYSLER CONCORDE V-6, 3.2 L 1998 - 2001  
 CHRYSLER CONCORDE V-6, 3.5 L 1993 - 2002  
 CHRYSLER CONCORDE V-6, 3.5 L 2003 - 2004  
 CHRYSLER INTREPID V-6, 3.2 L 1998 - 2001  
 CHRYSLER INTREPID V-6, 3.5 L 1993 - 2002  
 CHRYSLER LHS V-6, 3.5 L 1994 - 2001  
 CHRYSLER NEW YORKER V-6, 3.5 L 1994 - 1996  
 DODGE INTREPID V-6, 3.2 L 1998 - 2001  
 DODGE INTREPID V-6, 3.5 L 1995 - 2002  
 DODGE INTREPID V-6, 3.5 L 2003 - 2004

**38041**



CHEVROLET ASTRO 4 CIL, 2.5 L 1989 - 1989  
 CHEVROLET S SERIES PICKUP 4 CIL, 2.5 L 1989 - 1989  
 CHRYSLER GRAND VOYAGER V-6, 3.3 L 2000 - 2000  
 CHRYSLER TOWN & COUNTRY VAN V-6, 3.3 L 1990 - 2000  
 CHRYSLER TOWN & COUNTRY VAN V-6, 3.8 L 1994 - 2000  
 CHRYSLER VOYAGER V-6, 3.3 L 2000 - 2000  
 DODGE CARAVAN V-6, 3.3 L 1995 - 2000  
 DODGE CARAVAN V-6, 3.8 L 1996 - 1999  
 DODGE GRAND CARAVAN V-6, 3.3 L 1995 - 2000  
 DODGE GRAND CARAVAN V-6, 3.8 L 1995 - 2000

**38036**



CADILLAC DEVILLE V-8, 4.6 L 1998 - 2005  
 CADILLAC DTS V-8, 4.6 L 2006 - 2007  
 CADILLAC EL DORADO V-8, 4.6 L 1998 - 2002  
 CADILLAC SEVILLE V-8, 4.6 L 1998 - 2004  
 CHEVROLET CAMARO V-8, 5.7 L 2001 - 2002  
 CHEVROLET CAMARO Z28 V-8, 5.7 L 2000 - 2002  
 PONTIAC FIREBIRD V-8, 5.7 L 2001 - 2002

**38042**



NISSAN PICK-UP 4 CIL, 2.4 L 1990 - 1992  
 NISSAN PICK-UP 4 CIL, 2.4 L 1993 - 1997

**38037**



CHEVROLET P SERIES VAN V-6, 4.3 L 1992 - 1995

CHRYSLER 300M V-6, 3.5 L 1999 - 2004  
 CHRYSLER CIRRUS 4 CIL, 2.0 L 2000 - 2000  
 CHRYSLER CIRRUS 4 CIL, 2.4 L 1995 - 2000  
 CHRYSLER CIRRUS 4 CIL, 2.4 L 1998 - 1998  
 CHRYSLER CIRRUS 4 CIL, 2.4 L 1999 - 1999



CHRYSLER	CIRRUS	V-6, 2.5 L	1995	-	2000
CHRYSLER	CIRRUS	V-6, 2.5 L	1998	-	1999
CHRYSLER	CONCORDE	V-6, 2.7 L	2001	-	2002
CHRYSLER	CONCORDE	V-6, 3.2 L	1998	-	2001
CHRYSLER	CONCORDE	V-6, 3.5 L	1993	-	2002
CHRYSLER	CONCORDE	V-6, 3.5 L	2003	-	2004
CHRYSLER	DAYTONA	V-6, 3.0 L	1990	-	1993
CHRYSLER	GRAND VOYAGER	V-6, 3.0 L	2000	-	2000
CHRYSLER	GRAND VOYAGER	V-6, 3.3 L	2000	-	2000
CHRYSLER	INTREPID	V-6, 3.2 L	1998	-	2001
CHRYSLER	INTREPID	V-6, 3.5 L	1993	-	2002
CHRYSLER	LEBARON	V-6, 3.0 L	1990	-	1992
CHRYSLER	LEBARON	V-6, 3.0 L	1993	-	1995
CHRYSLER	LHS	V-6, 3.5 L	1994	-	2001
CHRYSLER	NEW YORKER	V-6, 3.3 L	1990	-	1992
CHRYSLER	NEW YORKER	V-6, 3.3 L	1993	-	1993
CHRYSLER	NEW YORKER	V-6, 3.5 L	1994	-	1996
CHRYSLER	NEW YORKER	V-6, 3.8 L	1991	-	1992
CHRYSLER	NEW YORKER	V-6, 3.8 L	1993	-	1993
CHRYSLER	SEBRING	4 CIL, 2.0 L	1995	-	1999
CHRYSLER	SEBRING	4 CIL, 2.4 L	1996	-	1999
CHRYSLER	SEBRING	V-6, 2.5 L	1995	-	1995
CHRYSLER	SEBRING	V-6, 2.5 L	1996	-	2000
CHRYSLER	TOWN & COUNTRY VAN	V-6, 3.0 L	1990	-	1990
CHRYSLER	TOWN & COUNTRY VAN	V-6, 3.3 L	1990	-	2000
CHRYSLER	TOWN & COUNTRY VAN	V-6, 3.8 L	1994	-	2000
CHRYSLER	VOYAGER	4 CIL, 2.4 L	2000	-	2000
CHRYSLER	VOYAGER	V-6, 3.0 L	2000	-	2000
CHRYSLER	VOYAGER	V-6, 3.3 L	2000	-	2000
DODGE	ADVENTURER	V-6, 3.3 L	1993	-	2000
DODGE	CARAVAN	4 CIL, 2.4 L	1997	-	1997
DODGE	CARAVAN	4 CIL, 2.4 L	1998	-	2000
DODGE	CARAVAN	V-6, 3.0 L	1995	-	1995
DODGE	CARAVAN	V-6, 3.0 L	1996	-	2000
DODGE	CARAVAN	V-6, 3.3 L	1995	-	2000
DODGE	CARAVAN	V-6, 3.8 L	1996	-	1999
DODGE	DAKOTA	4 CIL, 2.5 L	1996	-	2002
DODGE	DURANGO	V-8, 4.7 L	2002	-	2004
DODGE	GRAND CARAVAN	4 CIL, 2.4 L	1996	-	1997
DODGE	GRAND CARAVAN	V-6, 3.0 L	1995	-	2000
DODGE	GRAND CARAVAN	V-6, 3.3 L	1995	-	2000
DODGE	GRAND CARAVAN	V-6, 3.8 L	1995	-	2000
DODGE	INTREPID	V-6, 2.7 L	2004	-	2004
DODGE	INTREPID	V-6, 3.2 L	1998	-	2001
DODGE	INTREPID	V-6, 3.5 L	1995	-	2002
DODGE	INTREPID	V-6, 3.5 L	2003	-	2004
DODGE	RAM 1500	V-6, 3.7 L	2002	-	2005
DODGE	RAM 2500	V-8, 4.7L	2002	-	2003
DODGE	RAM SERIES PICKUP	V-6, 3.7 L	2002	-	2003
DODGE	RAM SERIES PICKUP	V-8, 4.7L	2002	-	2003
DODGE	SPIRIT	V-6, 3.0 L	1994	-	1994
DODGE	SPIRIT	V-6, 3.0 L	1995	-	1995
DODGE	STRATUS	4 CIL, 2.0 L	1995	-	2000
DODGE	STRATUS	4 CIL, 2.4 L	1995	-	2000
DODGE	STRATUS	V-6, 2.5 L	1995	-	2000
JEEP	CHEROKEE	4 CIL, 2.5 L	1995	-	1998
JEEP	CHEROKEE	4 CIL, 2.5 L	1999	-	2000
JEEP	CHEROKEE	6 CIL, 4.0 L	1995	-	2001
JEEP	GRAND CHEROKEE	6 CIL, 4.0 L	1994	-	1998
JEEP	GRAND CHEROKEE	V-8, 4.7 L	2002	-	2003
JEEP	LIBERTY	V-6, 3.7 L	2002	-	2007
JEEP	LIBERTY	V-6, 3.7 L	2005	-	2005
JEEP	WRANGLER	4 CIL, 2.5 L	1993	-	2002
JEEP	WRANGLER	6 CIL, 4.0 L	1995	-	1995
JEEP	WRANGLER	6 CIL, 4.0 L	1997	-	1999

**38043**



CHEVROLET	EQUINOX	V-6, 3.4 L	2005	-	2007
CHEVROLET	MALIBU	V-6, 3.1 L	2002	-	2003

CHEVROLET	MALIBU	V-6, 3.5 L	2004	-	2006
CHEVROLET	UPLANDER	V-6, 3.5 L	2005	-	2006
CHEVROLET	VENTURE	V-6, 3.4 L	2002	-	2005
CHRYSLER	CONCORDE	V-6, 2.7 L	1998	-	2000
CHRYSLER	CONCORDE	V-6, 2.7 L	2003	-	2003
CHRYSLER	INTREPID	V-6, 2.7 L	1998	-	2003
CHRYSLER	TOWN & COUNTRY	V-6, 3.8 L	2001	-	2007
CHRYSLER	TOWN & COUNTRY VAN	V-6, 3.3 L	2001	-	2006
CHRYSLER	TOWN & COUNTRY VAN	V-6, 3.8 L	2001	-	2006
CHRYSLER	VOYAGER	V-6, 3.3 L	2001	-	2007
DODGE	CARAVAN	V-6, 3.3 L	2001	-	2003
DODGE	CARAVAN	V-6, 3.3 L	2002	-	2007
DODGE	CARAVAN	V-6, 3.3 L FLEX	2001	-	2003
DODGE	DAKOTA	4 CIL, 2.5 L	1996	-	2002
DODGE	GRAND CARAVAN	V-6, 3.3 L	2001	-	2006
DODGE	GRAND CARAVAN	V-6, 3.8 L	2001	-	2006
DODGE	INTREPID	V-6, 2.7 L	1998	-	2003
JEEP	CHEROKEE	4 CIL, 2.5 L	1997	-	1998
JEEP	CHEROKEE	4 CIL, 2.5 L	1999	-	2000
JEEP	CHEROKEE	6 CIL, 4.0 L	1997	-	1999
JEEP	GRAND CHEROKEE	6 CIL, 4.0 L	1998	-	2002
JEEP	GRAND CHEROKEE	6 CIL, 4.0 L	2003	-	2003
JEEP	GRAND CHEROKEE	V-6, 4.0 L	2003	-	2003
JEEP	WRANGLER	4 CIL, 2.5 L	1997	-	2002
JEEP	WRANGLER	6 CIL, 4.0 L	1997	-	2006
JEEP	WRANGLER	6 CIL, 4.0 L	2004	-	2004
PONTIAC	AZTEK	V-6, 3.4 L	2003	-	2005
PONTIAC	G6	V-6, 3.5 L	2005	-	2005
PONTIAC	G6	V-6, 3.5 L	2006	-	2006
PONTIAC	MONTANA	V-6, 3.4 L	2003	-	2005
PONTIAC	MONTANA	V-6, 3.5 L	2005	-	2005
PONTIAC	MONTANA	V-6, 3.5 L	2006	-	2006
PONTIAC	TORRENT	V-6, 3.4 L	2006	-	2008
SATURN	RELAY	V-6, 3.5 L	2005	-	2006

**38044**



NISSAN	ALTIMA	4 CIL, 2.4 L	1998	-	2001
NISSAN	QUEST	V-6, 3.0 L	1993	-	1996
NISSAN	QUEST	V-6, 3.0 L	1997	-	1998
NISSAN	QUEST	V-6, 3.3 L	1999	-	2000

**38049**



FORD	AEROSTAR	V-6, 3.0 L	1994	-	1994
------	----------	------------	------	---	------

**38052**



FORD	E SERIES VAN	V-8, 7.3 L	1995	-	1996
FORD	E SERIES VAN	V-8, 7.3 L	1997	-	1997
FORD	F SERIES PICKUP	V-8, 7.3 L	1995	-	1997
FORD	SUPER DUTY PICKUP	V-8, 7.3 L	1995	-	1997
FORD	SUPER DUTY VAN	V-8, 7.3 L	1996	-	1996





### 38053

FORD	E SERIES VAN	V-10, 6.8 L	1998	-	1998
FORD	E SERIES VAN	V-8, 4.6 L	1997	-	1998
FORD	E SERIES VAN	V-8, 4.6 L	1999	-	2001
FORD	E SERIES VAN	V-8, 5.4 L	1997	-	2001
FORD	E SERIES VAN	V-8, 7.3 L	1998	-	1998
FORD	EXCURSION	V-8, 7.3 L	2000	-	2003
FORD	F SERIES PICKUP	V-8, 4.6 L	1997	-	1997
FORD	F SERIES PICKUP	V-8, 4.6 L	1998	-	2001
FORD	F SERIES PICKUP	V-8, 5.4 L	1997	-	1998
FORD	F SERIES PICKUP	V-8, 5.4 L	1999	-	2001
FORD	F-250	V-8, 4.6 L	1998	-	2004
FORD	F-450 SUPER DUTY	V-8, 7.3 L	2002	-	2003
FORD	SUPER DUTY PICKUP	V-8, 5.4 L	1999	-	2001
FORD	SUPER DUTY PICKUP	V-8, 7.3 L	1999	-	2002
FORD	SUPER DUTY PICKUP	V-8, 7.3 L	2003	-	2003
FORD	SUPER DUTY VAN	V-10, 6.8 L	1997	-	1998
FORD	SUPER DUTY VAN	V-10, 6.8 L	2000	-	2001
FORD	SUPER DUTY VAN	V-8, 5.4 L	1997	-	1998
FORD	SUPER DUTY VAN	V-8, 5.4 L	1999	-	2001
FORD	SUPER DUTY VAN	V-8, 7.3 L	1998	-	2003
FORD	SUPER DUTY VAN	V-8, 7.3 L	1999	-	2001



### 38063

BMW	540I	V-8, 4.4 L	1998	-	2001
BMW	540I	V-8, 4.4 L	2002	-	2003
BMW	740I	V-8, 4.4 L	1998	-	2001
BMW	740IL	V-8, 4.4 L	1998	-	2001
BMW	745I	V-8, 4.4 L	2005	-	2005
BMW	745LI	V-8, 4.4 L	2005	-	2005
BMW	750I	V-8, 4.8 L	2006	-	2006
BMW	750LI	V-8, 4.8 L	2006	-	2006
BMW	760I	V-12, 6.0 L	2005	-	2005
BMW	760LI	V-12, 6.0 L	2005	-	2005
BMW	X5	V-8, 4.4 L	2000	-	2000
BMW	X5	V-8, 4.4 L	2001	-	2001
BMW	X5	V-8, 4.4 L	2002	-	2003
BMW	X5	V-8, 4.6 L	2002	-	2002
BMW	X5	V-8, 4.6 L	2003	-	2003



### 38058

CHRYSLER	ASPEN	V-8, 5.7 L	2007	-	2009
DODGE	DURANGO	V-8, 5.7 L	2004	-	2007
DODGE	RAM 2500	V-8, 5.7 L	2008	-	2008
DODGE	RAM 3500	V-8, 5.7 L	2003	-	2007
DODGE	RAM SERIES PICKUP	V-10, 8.0 L	1995	-	1998
DODGE	RAM SERIES PICKUP	V-10, 8.0 L	1999	-	2000
DODGE	RAM SERIES PICKUP	V-8, 5.7 L	2003	-	2007
DODGE	RAM SERIES PICKUP	V-8, 5.9 L	1997	-	2001



### 38066

BMW	540I	V-8, 4.4 L	1998	-	2001
BMW	540I	V-8, 4.4 L	2002	-	2003
BMW	740I	V-8, 4.4 L	1998	-	2001
BMW	740IL	V-8, 4.4 L	1998	-	2001



### 38061

BMW	750IL	V-12, 5.4 L	1998	-	2000
-----	-------	-------------	------	---	------



### 38068

AUDI	A4	4 CIL, 1.8 L	1998	-	2001
VOLKSWAGEN	PASSAT	4 CIL, 1.8 L	1998	-	1998
VOLKSWAGEN	PASSAT	4 CIL, 1.8 L	1999	-	2004
VOLKSWAGEN	PASSAT	4 CIL, 1.8 L	2005	-	2005



### 38062

BMW	750IL	V-12, 5.4 L	1998	-	2000
-----	-------	-------------	------	---	------



### 38069

BMW	320I	6 CIL, 2.2 L	2001	-	2005
BMW	323CI	6 CIL, 2.5 L	2000	-	2000
BMW	323I	6 CIL, 2.5 L	1998	-	2000
BMW	323IS	6 CIL, 2.5 L	1998	-	1999
BMW	325CI	6 CIL, 2.5 L	2001	-	2005
BMW	325I	6 CIL, 2.5 L	2001	-	2005
BMW	325XI	6 CIL, 2.5 L	2001	-	2003
BMW	325XI	6 CIL, 2.5 L	2004	-	2005
BMW	328CI	6 CIL, 2.8 L	2000	-	2000
BMW	328I	6 CIL, 2.8 L	1998	-	2000



BMW	328IS	6 CIL, 2.8 L	1998 - 1999
BMW	330CI	6 CIL, 3.0 L	2001 - 2003
BMW	330CI	6 CIL, 3.0 L	2004 - 2005
BMW	330I	6 CIL, 3.0 L	2001 - 2005
BMW	330XI	6 CIL, 3.0 L	2001 - 2005
BMW	330XI	6 CIL, 3.0 L	2002 - 2004
BMW	525I	6 CIL, 2.5 L	2001 - 2005
BMW	528I	6 CIL, 2.8 L	1998 - 2000
BMW	530I	6 CIL, 3.0 L	2001 - 2005
BMW	530I	6 CIL, 3.0 L	2002 - 2002
BMW	M3	6 CIL, 3.2 L	1998 - 2005
BMW	M3	6 CIL, 3.2 L	2001 - 2002
BMW	X3	6 CIL, 2.5 L	2004 - 2006
BMW	X3	6 CIL, 3.0 L	2004 - 2004
BMW	X3	6 CIL, 3.0 L	2005 - 2006
BMW	X5	6 CIL, 3.0 L	2001 - 2004
BMW	X5	6 CIL, 3.0 L	2005 - 2005
BMW	Z3	6 CIL, 2.5 L	1999 - 2001
BMW	Z3	6 CIL, 2.8 L	1998 - 1998
BMW	Z3	6 CIL, 2.8 L	1999 - 2000
BMW	Z3	6 CIL, 3.0 L	2001 - 2001
BMW	Z3	6 CIL, 3.2 L	1998 - 1998
BMW	Z3	6 CIL, 3.2 L	1999 - 2002
BMW	Z4	6 CIL, 2.5 L	2003 - 2005
BMW	Z4	6 CIL, 2.5 L	2004 - 2004
BMW	Z4	6 CIL, 3.0 L	2003 - 2005
BMW	Z4	6 CIL, 3.0 L	2004 - 2004

**38070**



BMW	318I	4 CIL, 1.9 L	1998 - 1998
BMW	318I	4 CIL, 1.9 L	1999 - 1999
BMW	318IS	4 CIL, 1.9 L	1998 - 1999
BMW	318TI	4 CIL, 1.9 L	1998 - 1999
BMW	M3	6 CIL, 3.2 L	1998 - 1998
BMW	Z3	4 CIL, 1.9 L	1998 - 1998
BMW	Z3	6 CIL, 3.2 L	1998 - 1998
BMW	Z3	6 CIL, 3.2 L	1999 - 1999

**38071**



BMW	318I	4 CIL, 1.9 L	1998 - 1998
BMW	318I	4 CIL, 1.9 L	1999 - 1999
BMW	318IS	4 CIL, 1.9 L	1998 - 1999
BMW	318TI	4 CIL, 1.9 L	1998 - 1999
BMW	320I	6 CIL, 2.2 L	2001 - 2005
BMW	320I	V-6, 2.2 L	2004 - 2005
BMW	323CI	6 CIL, 2.5 L	2000 - 2000
BMW	323I	6 CIL, 2.5 L	1998 - 2000
BMW	323IS	6 CIL, 2.5 L	1998 - 1999
BMW	325CI	6 CIL, 2.5 L	2001 - 2005
BMW	325I	6 CIL, 2.5 L	2001 - 2005
BMW	325XI	6 CIL, 2.5 L	2001 - 2003
BMW	325XI	6 CIL, 2.5 L	2004 - 2005
BMW	328CI	6 CIL, 2.8 L	2000 - 2000
BMW	328I	6 CIL, 2.8 L	1998 - 2000
BMW	328I	V-6, 2.8 L	2000 - 2000
BMW	328IS	6 CIL, 2.8 L	1998 - 1999
BMW	330CI	6 CIL, 3.0 L	2001 - 2003
BMW	330CI	6 CIL, 3.0 L	2004 - 2005
BMW	330I	6 CIL, 3.0 L	2001 - 2005

BMW	330XI	6 CIL, 3.0 L	2001 - 2005
BMW	330XI	6 CIL, 3.0 L	2002 - 2004
BMW	525I	6 CIL, 2.5 L	2001 - 2005
BMW	528I	6 CIL, 2.8 L	1998 - 2000
BMW	530I	6 CIL, 3.0 L	2001 - 2005
BMW	530I	6 CIL, 3.0 L	2002 - 2002
BMW	M3	6 CIL, 3.2 L	1998 - 2005
BMW	M3	6 CIL, 3.2 L	2001 - 2002
BMW	X3	6 CIL, 2.5 L	2004 - 2006
BMW	X3	6 CIL, 3.0 L	2004 - 2004
BMW	X3	6 CIL, 3.0 L	2005 - 2006
BMW	X5	6 CIL, 3.0 L	2001 - 2004
BMW	X5	6 CIL, 3.0 L	2005 - 2005
BMW	X5	6 CIL, 3.0 L	2006 - 2006
BMW	Z3	6 CIL, 2.5 L	1999 - 2000
BMW	Z3	6 CIL, 2.8 L	1998 - 1998
BMW	Z3	6 CIL, 2.8 L	1999 - 2000
BMW	Z3	6 CIL, 3.2 L	1998 - 1998
BMW	Z3	6 CIL, 3.2 L	1999 - 2002

**38078**



AUDI	CABRIOLET	V-6, 2.8 L	1998 - 1998
------	-----------	------------	-------------

**38079**



VOLKSWAGEN	EUROVAN	5 CIL, 2.5 L	1995 - 1996
------------	---------	--------------	-------------

**38080**



VOLKSWAGEN	EUROVAN	5 CIL, 2.5 L	1995 - 1996
------------	---------	--------------	-------------

**38082**



CHRYSLER	300 C	V-6, 3.5 L	2007 - 2009
CHRYSLER	CROSSFIRE	V-6, 3.2 L	2004 - 2005
DODGE	CHARGER	V-6, 3.5 L	2007 - 2008
DODGE	CHARGER	V-6, 3.5 L	2009 - 2009
DODGE	SPRINTER	5 CIL, 2.7 L	2003 - 2006
MERCEDES BE	C240	V-6, 2.6 L	2001 - 2005
MERCEDES BE	C280	V-6, 2.8 L	1998 - 2000
MERCEDES BE	C320	V-6, 3.2 L	2001 - 2005
MERCEDES BE	C43	V-8, 4.3 L	1999 - 2000
MERCEDES BE	CL500	V-8, 5.0 L	2000 - 2005



MERCEDES BE	CL55	V-8, 5.5 L	2001	-	2006
MERCEDES BE	CLK320	V-6, 3.2 L	2001	-	2005
MERCEDES BE	CLK430	V-8, 4.3 L	2000	-	2003
MERCEDES BE	CLK500	V-8, 5.0 L	2003	-	2005
MERCEDES BE	CLK55	V-8, 5.5 L	2002	-	2005
MERCEDES BE	E320	V-6, 3.2 L	2001	-	2006
MERCEDES BE	E430	V-8, 4.3 L	2001	-	2001
MERCEDES BE	E430	V-8, 4.3 L	2002	-	2002
MERCEDES BE	E500	V-8, 5.0 L	2003	-	2005
MERCEDES BE	E55	V-8, 5.5 L	2001	-	2002
MERCEDES BE	G500	V-8, 5.0 L	2002	-	2005
MERCEDES BE	G55	V-8, 5.5 L	2003	-	2005
MERCEDES BE	ML320	V-6, 3.2 L	2001	-	2003
MERCEDES BE	ML350	V-6, 3.7 L	2003	-	2005
MERCEDES BE	ML430	V-8, 4.3 L	2001	-	2001
MERCEDES BE	ML500	V-8, 5.0 L	2002	-	2005
MERCEDES BE	ML55	V-8, 5.5 L	2001	-	2003
MERCEDES BE	S430	V-8, 4.3 L	2001	-	2005
MERCEDES BE	S500	V-8, 5.0 L	2001	-	2005
MERCEDES BE	S55	V-8, 5.5 L	2001	-	2002
MERCEDES BE	SL500	V-8, 5.0 L	2001	-	2005
MERCEDES BE	SLK320	V-6, 3.2 L	2001	-	2004
MERCEDES BE	SLK350	V-6, 3.5 L	2005	-	2005
MERCEDES BE	SPRINTER	4 CIL, 2.2 L	2006	-	2007
MERCEDES BE	SPRINTER	5 CIL, 2.7 L	2006	-	2007

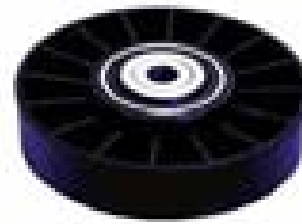

**38093**

AUDI	A6	V-8, 4.2 L	2000	-	2004
AUDI	A8	V-8, 3.7 L	1998	-	1998
AUDI	A8	V-8, 3.7 L	1999	-	1999
AUDI	A8	V-8, 4.2 L	1998	-	1998
AUDI	A8	V-8, 4.2 L	1999	-	2000
AUDI	A8	V-8, 4.2 L	2001	-	2006
AUDI	A8 QUATTRO	V-8, 4.2 L	1999	-	2000
AUDI	ALLROAD QUATTRO	V-8, 4.2 L	2004	-	2004
AUDI	RS 6	V-8, 4.2 L	2003	-	2004
AUDI	S6	V-8, 4.2 L	2002	-	2003
AUDI	S8	V-8, 4.2 L	2002	-	2003

**38099**

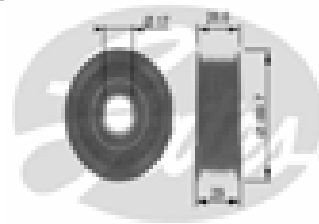

MERCEDES BE	SPRINTER	4 CIL, 2.2 L CDI	2006	-	2007
MERCEDES BE	SPRINTER	4 CIL, 2.2 L CDI	2008	-	2010
MERCEDES BE	SPRINTER	5 CIL, 2.7 L CDI	2003	-	2005
MERCEDES BE	SPRINTER	5 CIL, 2.7 L CDI	2006	-	2006
MERCEDES BE	VITO	4 CIL, 2.2 L	2008	-	2010

**38101**



CHEVROLET	G SERIES VAN	V-8, 7.4 L	1992	-	1996
-----------	--------------	------------	------	---	------

**38102**



FORD	AEROSTAR	V-6, 4.0 L	1996	-	1997
FORD	EXPLORER	V-6, 4.0 L	1993	-	1994
FORD	EXPLORER	V-6, 4.0 L	1995	-	2000
FORD	RANGER	V-6, 4.0 L	1994	-	1998
FORD	RANGER	V-6, 4.0 L	1999	-	2000
LAND ROVER	DISCOVERY	V-8, 4.0 L	2000	-	2004
MERCURY	MOUNTAINEER	V-6, 4.0 L	1998	-	1999



**38083**

SAAB	9 - 5	4 CIL, 2.3 L	2000	-	2000
------	-------	--------------	------	---	------



**38087**

VOLKSWAGEN	CABRIO	4 CIL, 2.0 L	1995	-	2002
VOLKSWAGEN	EUROVAN	5 CIL, 2.5 L	1995	-	1996
VOLKSWAGEN	GOLF	4 CIL, 1.9 L	1995	-	1998
VOLKSWAGEN	GOLF	4 CIL, 2.0 L	1995	-	2000
VOLKSWAGEN	JETTA	4 CIL, 1.9 L	1995	-	1998
VOLKSWAGEN	JETTA	4 CIL, 2.0 L	1994	-	2000
VOLKSWAGEN	PASSAT	4 CIL, 1.9 L	1995	-	1997
VOLKSWAGEN	PASSAT	4 CIL, 2.0 L	1995	-	1996



**38090**

MERCEDES BE	SL600	V-12, 6.0 L	2001	-	2001
-------------	-------	-------------	------	---	------



### 38103

CADILLAC	ESCALADE	V-8, 5.7 L	1999	-	2000
CHEVROLET	ASTRO	V-6, 4.3 L	1996	-	1999
CHEVROLET	BLAZER	V-6, 4.3 L	1996	-	2004
CHEVROLET	BLAZER	V-6, 4.3 L	2005	-	2005
CHEVROLET	C y K SERIES PICKUP	V-6, 4.3 L	1996	-	1998
CHEVROLET	C y K SERIES PICKUP	V-8, 5.0 L	1996	-	1996
CHEVROLET	C y K SERIES PICKUP	V-8, 5.0 L	1997	-	1999
CHEVROLET	C y K SERIES PICKUP	V-8, 5.7 L	1996	-	2000
CHEVROLET	C y K SERIES PICKUP	V-8, 7.4 L	1996	-	1998
CHEVROLET	C y K SERIES PICKUP	V-8, 7.4 L	1999	-	2000
CHEVROLET	C-2500	V-8, 5.7 L	1996	-	2000
CHEVROLET	C-3500	V-8, 5.7 L	1996	-	2000
CHEVROLET	EXPRESS	V-6, 4.3 L	1996	-	2003
CHEVROLET	EXPRESS	V-6, 4.3 L	2004	-	2007
CHEVROLET	EXPRESS	V-8, 5.0 L	1996	-	2002
CHEVROLET	EXPRESS	V-8, 5.7 L	1996	-	2002
CHEVROLET	EXPRESS	V-8, 7.4 L	1996	-	2000
CHEVROLET	EXPRESS CARGO VAN	V-6, 4.3 L	2005	-	2006
CHEVROLET	EXPRESS CARGO VAN	V-6, 4.3 L	2007	-	2010
CHEVROLET	G SERIES VAN	V-6, 4.3 L	1996	-	1998
CHEVROLET	G SERIES VAN	V-8, 5.0 L	1996	-	1998
CHEVROLET	G SERIES VAN	V-8, 5.7 L	1997	-	1998
CHEVROLET	G SERIES VAN	V-8, 7.4 L	1997	-	1998
CHEVROLET	G20 CHEVY VAN	V-6, 4.3 L	1996	-	1997
CHEVROLET	G30 CHEVY VAN	V-8, 5.7 L	1998	-	1998
CHEVROLET	P SERIES VAN	V-6, 4.3 L	1996	-	1999
CHEVROLET	P SERIES VAN	V-8, 5.7 L	1996	-	1999
CHEVROLET	P SERIES VAN	V-8, 7.4 L	1996	-	1999
CHEVROLET	P31 VANETTE	V-8, 5.7 L	1996	-	1999
CHEVROLET	PICKUP 1500	V-6, 4.3 L	2003	-	2003
CHEVROLET	S SERIES PICKUP	V-6, 4.3 L	1996	-	2004
CHEVROLET	S-10	V-6, 4.3 L	1996	-	2002
CHEVROLET	SILVERADO	V-6, 4.3 L	1999	-	2010
CHEVROLET	SILVERADO	V-6, 4.3 L	2000	-	2001
CHEVROLET	SILVERADO PICKUP	V-6, 4.3 L	1999	-	2007
CHEVROLET	SILVERADO PICKUP 1500	V-6, 4.3 L	2003	-	2003
CHEVROLET	SUBURBAN	V-8, 5.7 L	1996	-	1999
CHEVROLET	SUBURBAN	V-8, 7.4 L	1996	-	1999
CHEVROLET	TAHOE	V-8, 5.7 L	1996	-	2000
GMC	C y K SERIES PICKUP	V-8, 5.7 L	2000	-	2000
GMC	C y K SERIES PICKUP	V-8, 7.4 L	2000	-	2000
GMC	JIMMY	V-6, 4.3 L	2000	-	2005
GMC	SAFARI	V-6, 4.3 L	2000	-	2005
GMC	SAVANA	V-6, 4.3 L	2000	-	2007
GMC	SAVANA	V-8, 5.0 L	2000	-	2002
GMC	SAVANA	V-8, 5.7 L	2000	-	2002
GMC	SAVANA	V-8, 7.4 L	2000	-	2000
GMC	SIERRA SERIES PICKUP	V-6, 4.3 L	2000	-	2007
GMC	SONOMA	V-6, 4.3 L	2000	-	2004
GMC	YUKON	V-8, 5.7 L	2000	-	2000



### 38104

CHEVROLET	CUTLASS	V-6, 3.1 L	1997	-	1998
CHEVROLET	EQUINOX	V-6, 3.4 L	2005	-	2007
CHEVROLET	MALIBU	V-6, 3.1 L	1997	-	2003
CHEVROLET	MALIBU	V-6, 3.5 L	2004	-	2006
CHEVROLET	UPLANDER	V-6, 3.5 L	2005	-	2007

CHEVROLET	VENTURE	V-6, 3.4 L	1999	-	2005
OLDSMOBILE	CUTLASS	V-6, 3.1 L	1997	-	1999
OLDSMOBILE	SILHOUETTE	V-6, 3.4 L	1999	-	2000
PONTIAC	AZTEK	V-6, 3.4 L	2001	-	2005
PONTIAC	G6	V-6, 3.5 L	2005	-	2005
PONTIAC	G6	V-6, 3.5 L	2006	-	2006
PONTIAC	G6	V-6, 3.9 L	2006	-	2006
PONTIAC	GRAND AM	V-6, 3.4 L	1999	-	2005
PONTIAC	MONTANA	V-6, 3.4 L	1999	-	2005
PONTIAC	MONTANA	V-6, 3.5 L	2005	-	2005
PONTIAC	MONTANA	V-6, 3.5 L	2006	-	2006
PONTIAC	TORRENT	V-6, 3.4 L	2006	-	2008
PONTIAC	TRANS SPORT	V-6, 3.4 L	1999	-	1999
SATURN	RELAY	V-6, 3.5 L	2005	-	2006



### 38105

CHEVROLET	CAVALIER	V-6, 2.8 L	1989	-	1989
CHEVROLET	CAVALIER	V-6, 3.1 L	1990	-	1992
CHEVROLET	CAVALIER	V-6, 3.1 L	1993	-	1994
CHEVROLET	CELEBRITY	V-6, 2.8 L	1987	-	1989
CHEVROLET	CELEBRITY	V-6, 3.1 L	1990	-	1990
CHEVROLET	CENTURY	V-6, 2.8 L	1987	-	1988
CHEVROLET	CENTURY	V-6, 3.1 L	1994	-	1999
CHEVROLET	CENTURY	V-6, 3.1 L	2000	-	2000
CHEVROLET	CUTLASS	V-6, 2.8 L	1987	-	1989
CHEVROLET	CUTLASS	V-6, 3.1 L	1989	-	1992
CHEVROLET	CUTLASS	V-6, 3.1 L	1993	-	1996
CHEVROLET	CUTLASS EUROSPO	V-6, 2.8 L	1987	-	1989
CHEVROLET	IMPALA	V-6, 3.4 L	2000	-	2005
CHEVROLET	IMPALA	V-6, 3.4 L	2003	-	2003
CHEVROLET	LUMINA	V-6, 3.1 L	1990	-	1995
CHEVROLET	LUMINA	V-6, 3.1 L	1996	-	1997
CHEVROLET	LUMINA	V-6, 3.4 L	1991	-	1992
CHEVROLET	LUMINA	V-6, 3.4 L	1993	-	1995
CHEVROLET	LUMINA APV	V-6, 3.1 L	1990	-	1995
CHEVROLET	LUMINA APV	V-6, 3.4 L	1996	-	1996
CHEVROLET	MONTE CARLO	V-6, 3.4 L	2004	-	2005
CHEVROLET	VENTURE	V-6, 3.4 L	1997	-	1998
OLDSMOBILE	CUTLASS CIERA	V-6, 3.1 L	1995	-	1996
OLDSMOBILE	CUTLASS SUPREME	V-6, 3.1 L	1995	-	1997
OLDSMOBILE	SILHOUETTE	V-6, 3.1 L	1991	-	1992
OLDSMOBILE	SILHOUETTE	V-6, 3.4 L	1996	-	1996
OLDSMOBILE	SILHOUETTE	V-6, 3.4 L	1997	-	1997
PONTIAC	GRAND AM	V-6, 3.1 L	1995	-	1996
PONTIAC	GRAND AM	V-6, 3.1 L	1997	-	1997
PONTIAC	GRAND PRIX	V-6, 3.1 L	1995	-	1996
PONTIAC	GRAND PRIX	V-6, 3.1 L	1997	-	2002
PONTIAC	TRANS SPORT	V-6, 3.1 L	1995	-	1995
PONTIAC	TRANS SPORT	V-6, 3.4 L	1996	-	1997

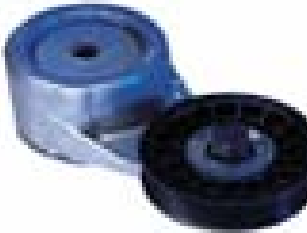

### 38106

CHEVROLET	ASTRO	V-6, 4.3 L	1990	-	1995
CHEVROLET	G SERIES VAN	V-6, 4.3 L	1992	-	1996
CHEVROLET	G SERIES VAN	V-8, 5.0 L	1992	-	1995
CHEVROLET	G SERIES VAN	V-8, 5.7 L	1992	-	1996
CHEVROLET	G20 CHEVY VAN	V-6, 4.3 L	1995	-	1996



### 38107

CHEVROLET	CAVALIER	4 CIL, 2.2 L	1995	-	1997
PONTIAC	SUNFIRE	4 CIL, 2.2 L	1995	-	1997



### 38111

CHEVROLET	CELEBRITY	4 CIL, 2.5 L	1989	-	1989
CHEVROLET	LUMINA	4 CIL, 2.5 L	1990	-	1992



### 38112

SATURN	S-SERIES	4 CIL, 1.9 L	1991	-	2002
--------	----------	--------------	------	---	------



### 38113

CHRYSLER	GRAND VOYAGER	V-6, 3.3 L	1991	-	1993
CHRYSLER	GRAND VOYAGER	V-6, 3.3 L	2000	-	2000
CHRYSLER	GRAND VOYAGER	V-6, 3.8 L	1994	-	1999
CHRYSLER	NEW YORKER	V-6, 3.3 L	1990	-	1992
CHRYSLER	NEW YORKER	V-6, 3.3 L	1993	-	1993
CHRYSLER	NEW YORKER	V-6, 3.8 L	1991	-	1992
CHRYSLER	NEW YORKER	V-6, 3.8 L	1993	-	1993
CHRYSLER	TOWN & COUNTRY	V-6, 3.8 L	1995	-	2000
CHRYSLER	TOWN & COUNTRY VAN	V-6, 3.3 L	1990	-	2000
CHRYSLER	TOWN & COUNTRY VAN	V-6, 3.8 L	1994	-	2000
CHRYSLER	VOYAGER	V-6, 3.3 L	1994	-	1995
CHRYSLER	VOYAGER	V-6, 3.3 L	1996	-	2000
CHRYSLER	VOYAGER	V-6, 3.8 L	1999	-	1999
CHRYSLER	VOYAGER TOWN N COUNTRY	V-6, 3.8 L	1995	-	2000
DODGE	ADVENTURER	V-6, 3.3 L	1993	-	2000
DODGE	CARAVAN	V-6, 3.3 L	1995	-	2000
DODGE	CARAVAN	V-6, 3.8 L	1996	-	1999
DODGE	GRAND CARAVAN	V-6, 3.3 L	1995	-	2000
DODGE	GRAND CARAVAN	V-6, 3.8 L	1995	-	2000



### 38114

FORD	AEROSTAR	V-6, 3.0 L	1995	-	1997
FORD	RANGER	V-6, 3.0 L	1994	-	1997
FORD	RANGER	V-6, 3.0 L	1996	-	2002
FORD	WINDSTAR	V-6, 3.0 L	1995	-	2000
FORD	WINDSTAR	V-6, 3.0 L	1998	-	1998
MERCURY	SABLE / TAURUS	V-6, 3.0 L	1996	-	2005

CHEVROLET	ASTRO	V-6, 4.3 L	1990	-	1995
CHEVROLET	G SERIES VAN	V-6, 4.3 L	1992	-	1995
CHEVROLET	G SERIES VAN	V-8, 5.0 L	1992	-	1995
CHEVROLET	G SERIES VAN	V-8, 5.7 L	1992	-	1996
CHEVROLET	G20 CHEVY VAN	V-8, 4.3 L	1995	-	1995



### 38108

CHEVROLET	ASTRO	V-6, 4.3 L	1989	-	1989
CHEVROLET	BLAZER	V-6, 4.3 L	1993	-	1995
CHEVROLET	BLAZER COMPACT	V-6, 4.3 L	1989	-	1994
CHEVROLET	BLAZER FULL SIZE	V-8, 5.7 L	1989	-	1994
CHEVROLET	C y K SERIES PICKUP	V-6, 4.3 L	1989	-	1994
CHEVROLET	C y K SERIES PICKUP	V-6, 4.3 L	1995	-	1995
CHEVROLET	C y K SERIES PICKUP	V-8, 5.0 L	1989	-	1995
CHEVROLET	C y K SERIES PICKUP	V-8, 5.7 L	1988	-	1992
CHEVROLET	C y K SERIES PICKUP	V-8, 5.7 L	1993	-	1995
CHEVROLET	C-20	V-8, 5.7 L	1990	-	1991
CHEVROLET	C-2500	V-8, 5.7 L	1992	-	1992
CHEVROLET	C-2500	V-8, 5.7 L	1993	-	1995
CHEVROLET	C-30	V-8, 5.7 L	1990	-	1993
CHEVROLET	C-35	V-8, 5.7 L	1990	-	1992
CHEVROLET	C-35	V-8, 5.7 L	1993	-	1993
CHEVROLET	C-3500	V-8, 5.7 L	1994	-	1995
CHEVROLET	G SERIES VAN	V-6, 4.3 L	1989	-	1991
CHEVROLET	G SERIES VAN	V-8, 5.0 L	1989	-	1991
CHEVROLET	G SERIES VAN	V-8, 5.7 L	1989	-	1991
CHEVROLET	S SERIES PICKUP	V-6, 4.3 L	1989	-	1995
CHEVROLET	S-10	V-6, 4.3 L	1992	-	1992
CHEVROLET	S-10	V-6, 4.3 L	1993	-	1995
CHEVROLET	SUBURBAN	V-8, 5.7 L	1989	-	1992
CHEVROLET	SUBURBAN	V-8, 5.7 L	1993	-	1995
CHEVROLET	TAHOE	V-8, 5.7 L	1995	-	1995



### 38109

CHEVROLET	CAVALIER	4 CIL, 2.0 L	1989	-	1989
CHEVROLET	CAVALIER	4 CIL, 2.2 L	1990	-	1992
CHEVROLET	CAVALIER	4 CIL, 2.2 L	1993	-	1994



### 38110



**38115**

FORD	F SERIES PICKUP	V-8, 5.0 L	1987	-	1992
FORD	F SERIES PICKUP	V-8, 5.8 L	1988	-	1992
FORD	F-200	V-8, 5.0 L	1990	-	1991
FORD	F-200	V-8, 5.8 L	1990	-	1991
FORD	F-250	V-8, 5.0 L	1992	-	1992
FORD	F-350 SUPER DUTY	V-8, 5.0 L	1990	-	1992
FORD	F-350 SUPER DUTY	V-8, 5.8 L	1992	-	1992



**38116**

DODGE	B SERIES VAN	V-6, 3.9 L	1995	-	2003
DODGE	B SERIES VAN	V-8, 5.2 L	1995	-	2003
DODGE	B SERIES VAN	V-8, 5.9 L	1995	-	2003
DODGE	D-150	V-6, 3.9 L	1992	-	1992
DODGE	D-150	V-6, 3.9 L	1993	-	1993
DODGE	D-250	V-8, 5.9 L	1992	-	1992
DODGE	D-250	V-8, 5.9 L	1993	-	1993
DODGE	D-350	V-8, 5.9 L	1992	-	1992
DODGE	D-350	V-8, 5.9 L	1993	-	1993
DODGE	DAKOTA	V-6, 3.9 L	1995	-	2003
DODGE	DAKOTA	V-8, 5.2 L	1995	-	1999
DODGE	DAKOTA	V-8, 5.9 L	1998	-	2003
DODGE	DURANGO	V-6, 3.9 L	1998	-	1999
DODGE	DURANGO	V-8, 5.2 L	1998	-	2000
DODGE	DURANGO	V-8, 5.9 L	1998	-	2003
DODGE	RAM 1500	V-6, 3.9 L	1994	-	2001
DODGE	RAM 2500	V-8, 5.2 L	1997	-	2001
DODGE	RAM 2500	V-8, 5.9 L	1994	-	2002
DODGE	RAM 2500 4 X 4	V-8, 5.9 L	2002	-	2002
DODGE	RAM 3500	V-8, 5.9 L	1994	-	2002
DODGE	RAM 4000	V-8, 5.9 L	1995	-	2002
DODGE	RAM CHARGER	V-8, 5.9 L	1992	-	1992
DODGE	RAM CHARGER	V-8, 5.9 L	1993	-	1993
DODGE	RAM MAXI VAN 1500	V-6, 3.9 L	1999	-	2002
DODGE	RAM MAXI VAN 2500	V-8, 5.2 L	1996	-	2002
DODGE	RAM MAXI VAN 3500	V-8, 5.9 L	1996	-	2002
DODGE	RAM MAXI WAGON 3500	V-8, 5.2 L	1996	-	1996
DODGE	RAM MAXI WAGON 3500	V-8, 5.9 L	1996	-	2002
DODGE	RAM SERIES PICKUP	V-6, 3.9 L	1994	-	2001
DODGE	RAM SERIES PICKUP	V-8, 5.2 L	1995	-	2001
DODGE	RAM SERIES PICKUP	V-8, 5.9 L	1994	-	2002
DODGE	RAM SERIES PICKUP	V-8, 5.9 L	2003	-	2003
DODGE	RAM VAN 1500	V-6, 3.9 L	1995	-	2002
DODGE	RAM VAN 2500	V-8, 5.2 L	2002	-	2002
DODGE	RAM VAN 3500	V-8, 5.9 L	1996	-	2002
DODGE	RAM W2500	V-8, 5.9 L	1995	-	1998
DODGE	RAM WAGON 1500	V-8, 5.2 L	1997	-	2001
DODGE	RAM WAGON 2500	V-8, 5.2 L	1997	-	2001
DODGE	RAM WAGON 2500	V-8, 5.9 L	1994	-	1995
DODGE	RAM WAGON 3500	V-8, 5.9 L	2002	-	2002
DODGE	RAM WAGON 3500 SLT	V-8, 5.9 L	2000	-	2000
JEEP	GRAND CHEROKEE	V-8, 5.2 L	1993	-	1998
JEEP	GRAND CHEROKEE	V-8, 5.9 L	1998	-	1998



**38117**

FORD	TOPAZ	4 CIL, 2.3 L	1989	-	1991
------	-------	--------------	------	---	------

**38118**



CHEVROLET	C y K SERIES PICKUP	V-8, 6.5 L	1999	-	2002
CHEVROLET	EXPRESS	V-8, 6.5 L	1999	-	2002
CHEVROLET	SILVERADO 2500 4X4	V-8, 6.5 L	1999	-	1999
GMC	C y K SERIES PICKUP	V-8, 6.5 L	2000	-	2002
GMC	SAVANA	V-8, 6.5 L	2000	-	2002

**38119**



FORD	E SERIES VAN	V-8, 7.3 L	1995	-	1996
FORD	E SERIES VAN	V-8, 7.3 L	1997	-	1997
FORD	F SERIES PICKUP	V-8, 7.3 L	1994	-	1997
FORD	SUPER DUTY PICKUP	V-8, 7.3 L	1994	-	1997
FORD	SUPER DUTY VAN	V-8, 7.3 L	1996	-	1997

**38121**



FORD	MUSTANG	V-8, 5.0 L	1982	-	1984
MERCURY	GRAND MARQUIS	V-8, 4.2 L	1982	-	1982
MERCURY	GRAND MARQUIS	V-8, 5.0 L	1983	-	1984

**38122**



CHRYSLER	DAYTONA	V-6, 3.0 L	1991	-	1993
CHRYSLER	GRAND VOYAGER	V-6, 3.0 L	2000	-	2000
CHRYSLER	LEBARON	V-6, 3.0 L	1991	-	1992
CHRYSLER	LEBARON	V-6, 3.0 L	1993	-	1995
CHRYSLER	VOYAGER	V-6, 3.0 L	2000	-	2000
DODGE	CARAVAN	V-6, 3.0 L	1995	-	1995
DODGE	CARAVAN	V-6, 3.0 L	1996	-	2000



DODGE	GRAND CARAVAN	V-6, 3.0 L	1995 - 2000
DODGE	SPIRIT	V-6, 3.0 L	1994 - 1994
DODGE	SPIRIT	V-6, 3.0 L	1995 - 1995



**38123**

FORD	BRONCO	V-8, 5.0 L	1994 - 1996
FORD	BRONCO	V-8, 5.8 L	1994 - 1996
FORD	E SERIES VAN	V-8, 5.0 L	1994 - 1996
FORD	E SERIES VAN	V-8, 5.8 L	1994 - 1996
FORD	F SERIES PICKUP	V-8, 5.0 L	1993 - 1994
FORD	F SERIES PICKUP	V-8, 5.0 L	1995 - 1996
FORD	F SERIES PICKUP	V-8, 5.8 L	1993 - 1994
FORD	F SERIES PICKUP	V-8, 5.8 L	1995 - 1997
FORD	F-250	V-8, 5.0 L	1993 - 1996
FORD	F-350 SUPER DUTY	V-8, 5.0 L	1993 - 1996
FORD	F-350 SUPER DUTY	V-8, 5.8 L	1993 - 1997

**38124**



CHRYSLER	DAYTONA	V-6, 3.0 L	1990 - 1990
CHRYSLER	LEBARON	V-6, 3.0 L	1990 - 1990
CHRYSLER	TOWN & COUNTRY VAN	V-6, 3.0 L	1990 - 1990

**38126**



CADILLAC	REGAL	V-6, 3.8 L	1994 - 1995
CHEVROLET	EIGHTY EIGHT	V-6, 3.8 L	1992 - 1994
CHEVROLET	LUMINA APV	V-6, 3.8 L	1992 - 1995
CHEVROLET	REGAL	V-6, 3.8 L	1994 - 1995
OLDSMOBILE	SILHOUETTE	V-6, 3.1 L	1994 - 1994
OLDSMOBILE	SILHOUETTE	V-6, 3.8 L	1994 - 1995
PONTIAC	BONNEVILLE	V-6, 3.8 L	1994 - 1994
PONTIAC	TRANS SPORT	V-6, 3.8 L	1995 - 1995

**38127**



FORD	MUSTANG	V-6, 3.8 L	1994 - 2003
FORD	MUSTANG	V-6, 3.8 L	1996 - 2001
FORD	THUNDERBIRD	V-6, 3.8 L	1989 - 1997
FORD	THUNDERBIRD	V-6, 3.8 L	1994 - 1994
MERCURY	COUGAR	V-6, 3.8 L	1989 - 1997
MERCURY	COUGAR LS	V-6, 3.8 L	1990 - 1990
MERCURY	COUGAR XR7	V-6, 3.8 L	1991 - 1991

MERCURY	COUGAR XR7	V-6, 3.8 L	1993 - 1994
---------	------------	------------	-------------

**38129**



FORD	ESCORT	4 CIL, 1.9 L	1994 - 1996
------	--------	--------------	-------------

**38130**



CHEVROLET	BLAZER COMPACT	V-6, 2.8 L	1989 - 1989
CHEVROLET	S SERIES PICKUP	V-6, 2.8 L	1989 - 1993

**38131**



FORD	E SERIES VAN	6 CIL, 4.9 L	1994 - 1994
FORD	E SERIES VAN	6 CIL, 4.9 L	1995 - 1996
FORD	F SERIES PICKUP	6 CIL, 4.9 L	1994 - 1996
FORD	F SERIES PICKUP	V-6, 4.9 L	1995 - 1996
FORD	F-150	V-6, 4.9 L	1995 - 1996

**38132**



FORD	CROWN VICTORIA	V-8, 4.6 L	1996 - 1999
FORD	MUSTANG	V-8, 4.6 L	1996 - 1999
FORD	THUNDERBIRD	V-8, 4.6 L	1994 - 1997
LINCOLN	MARK VIII	V-8, 4.6 L	1994 - 1998
LINCOLN	TOWN CAR	V-8, 4.6 L	1992 - 1992
LINCOLN	TOWN CAR	V-8, 4.6 L	1993 - 1999
MERCURY	COUGAR	V-8, 4.6 L	1994 - 1997
MERCURY	GRAND MARQUIS	V-8, 4.6 L	1992 - 1992
MERCURY	GRAND MARQUIS	V-8, 4.6 L	1993 - 1999

**38133**



FORD	E SERIES VAN	V-10, 6.8 L	1997 - 1998
FORD	E SERIES VAN	V-8, 4.6 L	1997 - 1998
FORD	E SERIES VAN	V-8, 4.6 L	1999 - 2001



FORD	E SERIES VAN	V-8, 5.4 L	1997	-	2002
FORD	EXCURSION	V-10, 6.8 L	2000	-	2003
FORD	EXCURSION	V-8, 5.4 L	2000	-	2001
FORD	EXPEDITION	V-8, 4.6 L	1997	-	2002
FORD	EXPEDITION	V-8, 5.4 L	1997	-	2002
FORD	F SERIES PICKUP	V-10, 6.8 L	1999	-	2000
FORD	F SERIES PICKUP	V-10, 6.8 L	2001	-	2001
FORD	F SERIES PICKUP	V-8, 4.6 L	1997	-	1997
FORD	F SERIES PICKUP	V-8, 4.6 L	1998	-	2001
FORD	F SERIES PICKUP	V-8, 5.4 L	1997	-	1998
FORD	F SERIES PICKUP	V-8, 5.4 L	1999	-	2002
FORD	F-250	V-8, 4.6 L	1998	-	2001
FORD	F-250 LOBO	V-8, 5.4 L	1999	-	2001
FORD	F-350 SUPER DUTY	V-8, 5.4 L	1999	-	2006
FORD	F-450 SUPER DUTY	V-10, 6.8 L	1999	-	2006
FORD	LOBO	V-8, 5.4 L	2002	-	2002
FORD	SERIES F SUPER DUTY	V-10, 6.8 L	2002	-	2002
FORD	SERIES F SUPER DUTY	V-8, 5.4 L	2002	-	2002
FORD	SUPER DUTY PICKUP	V-10, 6.8 L	1999	-	2002
FORD	SUPER DUTY PICKUP	V-10, 6.8 L	2001	-	2001
FORD	SUPER DUTY PICKUP	V-8, 5.4 L	1999	-	2002
FORD	SUPER DUTY VAN	V-10, 6.8 L	1997	-	1998
FORD	SUPER DUTY VAN	V-10, 6.8 L	1999	-	2001
FORD	SUPER DUTY VAN	V-8, 5.4 L	1997	-	1997
FORD	SUPER DUTY VAN	V-8, 5.4 L	1999	-	2001
LINCOLN	NAVIGATOR	V-8, 5.4 L	1998	-	2002

**38137**

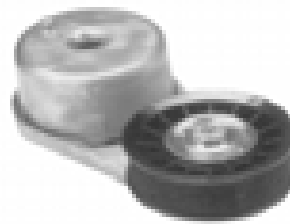

FORD	EXPLORER	V-6, 4.0 L	2000	-	2010
FORD	EXPLORER SPORT TRAC	V-6, 4.0 L	2001	-	2010
FORD	RANGER	V-6, 4.0 L	2001	-	2001
FORD	RANGER	V-6, 4.0 L	2002	-	2005
MERCURY	MOUNTAINEER	V-6, 4.0 L	2000	-	2005

**38138**



FORD	E SERIES VAN	V-6, 4.2 L	1997	-	2003
FORD	F SERIES PICKUP	V-6, 4.2 L	1997	-	2006
FORD	F SERIES PICKUP	V-6, 4.2 L	1998	-	2002
FORD	F-150	V-6, 4.2 L	1998	-	2008
FORD	SUPER DUTY VAN	V-6, 4.2 L	2001	-	2001

**38139**



**38134**

FORD	AEROSTAR	V-6, 4.0 L	1990	-	1992
FORD	AEROSTAR	V-6, 4.0 L	1993	-	1995
FORD	EXPLORER	V-6, 4.0 L	1991	-	1992

**38135**



CHEVROLET	ASTRO	V-6, 4.3 L	1989	-	1989
CHEVROLET	C y K SERIES PICKUP	V-6, 4.3 L	1989	-	1989
CHEVROLET	C y K SERIES PICKUP	V-8, 5.0 L	1989	-	1989
CHEVROLET	C y K SERIES PICKUP	V-8, 5.7 L	1988	-	1989
CHEVROLET	G SERIES VAN	V-6, 4.3 L	1989	-	1991
CHEVROLET	G SERIES VAN	V-8, 5.0 L	1989	-	1991
CHEVROLET	G SERIES VAN	V-8, 5.7 L	1989	-	1991

**38136**



CHEVROLET	SILVERADO	V-8, 6.6 L	2001	-	2001
GMC	SIERRA SERIES PICKUP	V-8, 6.6 L	2001	-	2001

FORD	TAURUS	V-6, 3.8 L	1988	-	1993
FORD	WINDSTAR	V-6, 3.8 L	1995	-	1998
MERCURY	SABLE / TAURUS	V-6, 3.8 L	1990	-	1992
MERCURY	SABLE / TAURUS	V-6, 3.8 L	1993	-	1995

**38140**



FORD	E SERIES VAN	V-8, 7.5 L	1994	-	1996
FORD	F SERIES PICKUP	V-8, 7.5 L	1994	-	1996
FORD	F SERIES PICKUP	V-8, 7.5 L	1997	-	1997
FORD	F-450 SUPER DUTY	V-8, 7.5 L	1997	-	1997
FORD	SUPER DUTY PICKUP	V-8, 7.5 L	1994	-	1997
FORD	SUPER DUTY VAN	V-8, 7.5 L	1996	-	1996

**38143**

CHEVROLET	C y K SERIES PICKUP	V-8, 7.4 L	1989	-	1993
-----------	---------------------	------------	------	---	------





CHEVROLET	G SERIES VAN	V-8, 7.4 L	1989	-	1991
CHEVROLET	SUBURBAN	V-8, 7.4 L	1989	-	1992
CHEVROLET	SUBURBAN	V-8, 7.4 L	1993	-	1993

**38144**



**38148**

CHEVROLET	ASTRO	4 CIL, 2.5 L	1989	-	1990
CHEVROLET	S SERIES PICKUP	4 CIL, 2.5 L	1989	-	1993

**38145**

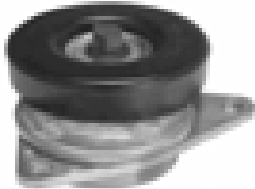

CHEVROLET	CAMARO	V-6, 3.4 L	1995	-	1995
CHEVROLET	CAMARO	V-8, 5.7 L	1995	-	1997
CHEVROLET	CAMARO Z28	V-8, 5.7 L	1995	-	1995
CHEVROLET	CAMARO Z28	V-8, 5.7 L	1996	-	1997
CHEVROLET	CAPRICE	V-8, 4.3 L	1996	-	1996
CHEVROLET	IMPALA SS	V-8, 5.7 L	1995	-	1996
PONTIAC	FIREBIRD	V-6, 3.4 L	1995	-	1995
PONTIAC	FIREBIRD	V-8, 5.7 L	1995	-	1997
PONTIAC	FIREBIRD TRANS AM	V-8, 5.7 L	1997	-	1997

**38146**



CHEVROLET	CAVALIER	4 CIL, 2.3 L	1995	-	1995
CHEVROLET	CAVALIER	4 CIL, 2.4 L	1996	-	1998
CHEVROLET	MALIBU	4 CIL, 2.4 L	1997	-	1998
PONTIAC	GRAND AM	4 CIL, 2.3 L	1995	-	1995
PONTIAC	GRAND AM	4 CIL, 2.4 L	1996	-	1997
PONTIAC	GRAND AM	4 CIL, 2.4 L	1999	-	1999
PONTIAC	SUNFIRE	4 CIL, 2.3 L	1995	-	1995
PONTIAC	SUNFIRE	4 CIL, 2.4 L	1996	-	1998

**38147**

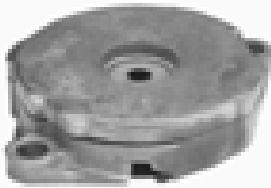

VOLKSWAGEN	CABRIO	4 CIL, 2.0 L	1995	-	2002
VOLKSWAGEN	GOLF	4 CIL, 2.0 L	1994	-	2000
VOLKSWAGEN	GTI	4 CIL, 2.0 L	1999	-	2000
VOLKSWAGEN	JETTA	4 CIL, 2.0 L	1994	-	2000
VOLKSWAGEN	PASSAT	4 CIL, 2.0 L	1993	-	1996

AUDI	TT	4 CIL, 1.8 L	2000	-	2006
AUDI	TT	4 CIL, 1.8 L	2001	-	2005
SEAT	AHLAMBRA	4 CIL, 1.8 L	2003	-	2007
SEAT	CORDOBA	4 CIL, 2.0 L	2003	-	2007
SEAT	IBIZA	4 CIL, 2.0 L	2003	-	2009
SEAT	LEON	4 CIL, 1.8 L	2003	-	2005
SEAT	TOLEDO	4 CIL, 1.8 L	2003	-	2005
VOLKSWAGEN	BEETLE	4 CIL, 1.8 L	1998	-	1998
VOLKSWAGEN	BEETLE	4 CIL, 1.8 L	1999	-	2005
VOLKSWAGEN	BEETLE	4 CIL, 1.9 L	2004	-	2005
VOLKSWAGEN	BEETLE	4 CIL, 2.0 L	1998	-	2008
VOLKSWAGEN	GOLF	4 CIL, 1.8 L	2000	-	2006
VOLKSWAGEN	GOLF	4 CIL, 1.8 L	2002	-	2002
VOLKSWAGEN	GOLF	4 CIL, 1.9 L	2004	-	2005
VOLKSWAGEN	GOLF	4 CIL, 2.0 L	1999	-	2006
VOLKSWAGEN	JETTA	4 CIL, 1.8 L	2000	-	2006
VOLKSWAGEN	JETTA	4 CIL, 1.9 L	2004	-	2005
VOLKSWAGEN	JETTA	4 CIL, 1.9 L DIESEL	2004	-	2005
VOLKSWAGEN	JETTA	4 CIL, 2.0 L	1999	-	2010
VOLKSWAGEN	PASSAT	4 CIL, 2.0 L	2006	-	2006
VOLKSWAGEN	SHARAN	4 CIL, 1.8 L	2003	-	2007

**38150**



FORD	FREESTAR	V-6, 3.9 L	2004	-	2005
FORD	FREESTAR	V-6, 4.2 L	2004	-	2005
FORD	WINDSTAR	V-6, 3.8 L	1999	-	2003

**38151**



AUDI	A4	4 CIL, 1.8 L	1998	-	2002
AUDI	A4 QUATTRO	4 CIL, 1.8 L	1998	-	2001
VOLKSWAGEN	PASSAT	4 CIL, 1.8 L	1998	-	1998
VOLKSWAGEN	PASSAT	4 CIL, 1.8 L	1999	-	2005

**38152**



CADILLAC	REGAL	V-6, 3.8 L	1996	-	1996
CHEVROLET	CAMARO	V-6, 3.8 L	1995	-	1997
CHEVROLET	EIGHTY EIGHT	V-6, 3.8 L	1995	-	1995
CHEVROLET	LUMINA	V-6, 3.8 L	1998	-	1998
CHEVROLET	REGAL	V-6, 3.8 L	1996	-	1996



OLDSMOBILE	EIGHTY EIGHT	V-6, 3.8 L	1995	-	1997
OLDSMOBILE	EIGHTY EIGHT	V-6, 3.8 L	1998	-	1998
OLDSMOBILE	LSS	V-6, 3.8 L	1997	-	1998
OLDSMOBILE	NINETY EIGHT	V-6, 3.8 L	1995	-	1996
OLDSMOBILE	REGENCY	V-6, 3.8 L	1997	-	1998
PONTIAC	BONNEVILLE	V-6, 3.8 L	1995	-	1998
PONTIAC	FIREBIRD	V-6, 3.8 L	1995	-	1997
PONTIAC	GRAND PRIX	V-6, 3.8 L	1997	-	1998



**38153**

CADILLAC	DEVILLE	V-8, 4.6 L	1998	-	2005
CADILLAC	DTS	V-8, 4.6 L	2006	-	2007
CADILLAC	EL DORADO	V-8, 4.6 L	1994	-	1999
CADILLAC	EL DORADO	V-8, 4.6 L	2000	-	2002
CADILLAC	SEVILLE	V-8, 4.6 L	1998	-	2004



**38155**

FORD	RANGER	4 CIL, 2.3 L	1994	-	1994
FORD	RANGER	4 CIL, 2.3 L	1995	-	2010
FORD	RANGER	4 CIL, 2.5 L	1998	-	2001



**38156**

CHEVROLET	TRACKER	4 CIL, 2.0 L	1999	-	2003
SUZUKI	AERIO	4 CIL, 2.3 L	2004	-	2004
SUZUKI	AERIO	4 CIL, 2.3 L	2005	-	2006
SUZUKI	SX4	4 CIL, 2.0 L	2007	-	2010
SUZUKI	VITARA	4 CIL, 2.0 L	2004	-	2004



**38157**

DODGE	RAM SERIES PICKUP	6 CIL, 5.9 L	1995	-	2002
DODGE	RAM SERIES PICKUP	6 CIL, 5.9 L Diesel	1999	-	2002



**38158**

CADILLAC	ESCALADE	V-8, 5.3 L	2002	-	2004
CADILLAC	ESCALADE	V-8, 5.3 L	2005	-	2005
CADILLAC	ESCALADE	V-8, 6.0 L	2002	-	2006
CADILLAC	ESCALADE	V-8, 6.2 L	2007	-	2008
CHEVROLET	AVALANCHE	V-8, 5.3 L	2002	-	2008
CHEVROLET	AVALANCHE	V-8, 5.3 L	2006	-	2006
CHEVROLET	EXPRESS	V-8, 4.8 L	2003	-	2007
CHEVROLET	EXPRESS	V-8, 5.3 L	2003	-	2008
CHEVROLET	EXPRESS	V-8, 6.0 L	2003	-	2008
CHEVROLET	SILVERADO	V-8, 4.8 L	2001	-	2008
CHEVROLET	SILVERADO	V-8, 5.3 L	2000	-	2008
CHEVROLET	SILVERADO	V-8, 6.0 L	2000	-	2007
CHEVROLET	SILVERADO 2500	V-8, 5.3 L	1999	-	1999
CHEVROLET	SILVERADO 2500 4X4	V-8, 5.3 L	1999	-	2002
CHEVROLET	SILVERADO 2500 4X4	V-8, 6.0 L	1999	-	1999
CHEVROLET	SILVERADO PICKUP	V-8, 4.8 L	1999	-	2007
CHEVROLET	SILVERADO PICKUP	V-8, 5.3 L	1999	-	2007
CHEVROLET	SILVERADO PICKUP	V-8, 6.0 L	1999	-	2007
CHEVROLET	SSR	V-8, 5.3 L	2003	-	2004
CHEVROLET	SSR	V-8, 6.0 L	2005	-	2006
CHEVROLET	SUBURBAN	V-8, 5.3 L	2000	-	2008
CHEVROLET	SUBURBAN	V-8, 6.0 L	2000	-	2008
CHEVROLET	TAHOE	V-8, 4.8 L	2000	-	2005
CHEVROLET	TAHOE	V-8, 4.8 L	2006	-	2007
CHEVROLET	TAHOE	V-8, 5.3 L	2000	-	2005
CHEVROLET	TAHOE	V-8, 5.3 L	2006	-	2008
CHEVROLET	TRAILBLAZER	V-8, 5.3 L	2003	-	2007
CHEVROLET	TRAILBLAZER	V-8, 5.3 L	2004	-	2004
CHEVROLET	TRAILBLAZER	V-8, 6.0 L	2006	-	2006
CHEVROLET	TRAILBLAZER	V-8, 6.0 L	2007	-	2007
CHEVROLET	TRAILBLAZER EXT	V-8, 5.3 L	2004	-	2004
GMC	ENVOY	V-8, 5.3 L	2003	-	2007
GMC	SAVANA	V-8, 4.8 L	2003	-	2007
GMC	SAVANA	V-8, 5.3 L	2003	-	2007
GMC	SAVANA	V-8, 6.0 L	2003	-	2007
GMC	SIERRA	V-8, 6.2 L	2007	-	2008
GMC	SIERRA SERIES PICKUP	V-8, 4.8 L	2000	-	2007
GMC	SIERRA SERIES PICKUP	V-8, 5.3 L	2000	-	2007
GMC	SIERRA SERIES PICKUP	V-8, 6.0 L	2000	-	2007
GMC	SIERRA SERIES PICKUP	V-8, 6.2 L	2007	-	2007
GMC	YUKON	V-8, 4.8 L	2000	-	2007
GMC	YUKON	V-8, 5.3 L	2000	-	2006
GMC	YUKON	V-8, 5.3 L	2007	-	2008
GMC	YUKON	V-8, 6.0 L	2000	-	2007
GMC	YUKON	V-8, 6.2 L	2007	-	2008
HUMMER	H2	V-8, 6.0 L	2005	-	2007
HUMMER	H2	V-8, 6.2 L	2008	-	2008
SAAB	9-7X	V-8, 5.3 L	2005	-	2007



**38159**

CADILLAC	ESCALADE	V-8, 5.3 L	2002	-	2004
CADILLAC	ESCALADE	V-8, 5.3 L	2005	-	2005
CADILLAC	ESCALADE	V-8, 6.0 L	2002	-	2006
CADILLAC	ESCALADE	V-8, 6.2 L	2007	-	2008
CHEVROLET	AVALANCHE	V-8, 5.3 L	2002	-	2008
CHEVROLET	AVALANCHE	V-8, 5.3 L	2006	-	2006
CHEVROLET	EXPRESS	V-8, 4.8 L	2003	-	2007



CHEVROLET	EXPRESS	V-8, 5.3 L	2003	-	2008
CHEVROLET	EXPRESS	V-8, 6.0 L	2003	-	2008
CHEVROLET	SILVERADO	V-8, 4.8 L	2001	-	2008
CHEVROLET	SILVERADO	V-8, 5.3 L	2000	-	2008
CHEVROLET	SILVERADO	V-8, 6.0 L	2000	-	2007
CHEVROLET	SILVERADO 2500	V-8, 5.3 L	1999	-	2002
CHEVROLET	SILVERADO 2500 4X4	V-8, 5.3 L	1999	-	2002
CHEVROLET	SILVERADO 2500 4X4	V-8, 6.0 L	1999	-	1999
CHEVROLET	SILVERADO PICKUP	V-8, 4.8 L	1999	-	2007
CHEVROLET	SILVERADO PICKUP	V-8, 5.3 L	1999	-	2007
CHEVROLET	SILVERADO PICKUP	V-8, 6.0 L	1999	-	2007
CHEVROLET	SSR	V-8, 5.3 L	2003	-	2004
CHEVROLET	SSR	V-8, 6.0 L	2005	-	2006
CHEVROLET	SUBURBAN	V-8, 5.3 L	2000	-	2008
CHEVROLET	SUBURBAN	V-8, 6.0 L	2000	-	2008
CHEVROLET	TAHOE	V-8, 4.8 L	2000	-	2005
CHEVROLET	TAHOE	V-8, 4.8 L	2006	-	2007
CHEVROLET	TAHOE	V-8, 5.3 L	2000	-	2005
CHEVROLET	TAHOE	V-8, 5.3 L	2006	-	2008
CHEVROLET	TRAILBLAZER	V-8, 5.3 L	2003	-	2007
CHEVROLET	TRAILBLAZER	V-8, 5.3 L	2004	-	2004
CHEVROLET	TRAILBLAZER	V-8, 6.0 L	2006	-	2006
CHEVROLET	TRAILBLAZER	V-8, 6.0 L	2007	-	2007
CHEVROLET	TRAILBLAZER EXT	V-8, 5.3 L	2004	-	2004
GMC	ENVOY	V-8, 5.3 L	2003	-	2007
GMC	SAVANA	V-8, 4.8 L	2003	-	2007
GMC	SAVANA	V-8, 5.3 L	2003	-	2007
GMC	SAVANA	V-8, 6.0 L	2003	-	2007
GMC	SIERRA	V-8, 6.2 L	2007	-	2008
GMC	SIERRA SERIES PICKUP	V-8, 4.8 L	2000	-	2007
GMC	SIERRA SERIES PICKUP	V-8, 5.3 L	2000	-	2007
GMC	SIERRA SERIES PICKUP	V-8, 6.0 L	2000	-	2007
GMC	SIERRA SERIES PICKUP	V-8, 6.2 L	2007	-	2007
GMC	YUKON	V-8, 4.8 L	2000	-	2007
GMC	YUKON	V-8, 5.3 L	2000	-	2006
GMC	YUKON	V-8, 5.3 L	2007	-	2008
GMC	YUKON	V-8, 6.0 L	2000	-	2007
GMC	YUKON	V-8, 6.2 L	2007	-	2008
HUMMER	H2	V-8, 6.0 L	2005	-	2007
HUMMER	H2	V-8, 6.2 L	2008	-	2008
SAAB	9-7X	V-8, 5.3 L	2005	-	2007

**38160**



FORD	CONTOUR	4 CIL, 2.0 L	1995	-	1997
FORD	CONTOUR	4 CIL, 2.0 L	1996	-	1996
MERCURY	MYSTIQUE	4 CIL, 2.0 L	1995	-	1997

**38161**



FORD	EXPLORER	V-8, 5.0 L	1996	-	1997
FORD	EXPLORER	V-8, 5.0 L	1998	-	2001
MERCURY	MOUNTAINEER	V-8, 5.0 L	1997	-	2000



**38162**

FORD	ESCORT	4 CIL, 2.0 L	1998	-	2002
FORD	ZX2	4 CIL, 2.0 L	2001	-	2003

**38163**



JEEP	GRAND CHEROKEE	6 CIL, 4.0 L	1999	-	2002
JEEP	GRAND CHEROKEE	6 CIL, 4.0 L	2003	-	2004
JEEP	WRANGLER	6 CIL, 4.0 L	2000	-	2006
JEEP	WRANGLER	6 CIL, 4.0 L	2004	-	2004

**38164**



CHEVROLET	CAVALIER	4 CIL, 2.2 L	1998	-	2002
PONTIAC	SUNFIRE	4 CIL, 2.2 L	1998	-	2002

**38165**



CHEVROLET	S SERIES PICKUP	4 CIL, 2.2 L	1998	-	2003
CHEVROLET	S-10	4 CIL, 2.2 L	1998	-	2001
CHEVROLET	S-10	4 CIL, 2.2 L	2002	-	2002
GMC	SONOMA	4 CIL, 2.2 L	2000	-	2003

**38167**



DODGE	DAKOTA	V-6, 3.7 L	2004	-	2006
DODGE	DAKOTA	V-6, 3.7 L	2007	-	2008
DODGE	DAKOTA	V-8, 4.7 L	2000	-	2007
DODGE	DURANGO	V-6, 3.7 L	2004	-	2004
DODGE	DURANGO	V-6, 3.7 L	2005	-	2005
DODGE	DURANGO	V-6, 3.7 L	2006	-	2006
DODGE	DURANGO	V-6, 3.7 L	2006	-	2006
DODGE	DURANGO	V-8, 4.7 L	2000	-	2006
DODGE	NITRO	V-6, 3.7 L	2007	-	2008
DODGE	RAM 1500	V-6, 3.7 L	2004	-	2005



DODGE	RAM 2500	V-8, 4.7L	2002	-	2003
DODGE	RAM PICK UP 1500	V-6, 3.7 L	2004	-	2007
DODGE	RAM PICK UP 2500	V-8, 4.7 L	2005	-	2007
DODGE	RAM PICK UP 2500	V-8, 4.7L	2006	-	2006
DODGE	RAM SERIES PICKUP	V-6, 3.7 L	2002	-	2003
DODGE	RAM SERIES PICKUP	V-6, 3.7 L	2004	-	2007
DODGE	RAM SERIES PICKUP	V-8, 4.7 L	2002	-	2007
JEEP	COMMANDER	V-6, 3.7 L	2006	-	2006
JEEP	COMMANDER	V-8, 4.7 L	2006	-	2006
JEEP	GRAND CHEROKEE	V-6, 3.7 L	2005	-	2007
JEEP	GRAND CHEROKEE	V-8, 4.7 L	1999	-	2007
JEEP	LIBERTY	V-6, 3.7 L	2002	-	2007

**38168**



TOYOTA	4 RUNNER	V-8, 4.7 L	2003	-	2007
TOYOTA	LAND CRUISER	V-8, 4.7 L	2000	-	2002
TOYOTA	LAND CRUISER	V-8, 4.7 L	2003	-	2007
TOYOTA	SEQUOIA	V-8, 4.7 L	2001	-	2006
TOYOTA	SEQUOIA	V-8, 4.7 L	2007	-	2008
TOYOTA	TUNDRA	V-8, 4.7 L	2000	-	2006
TOYOTA	TUNDRA	V-8, 4.7 L	2007	-	2008

**38173**



**38174**



FORD	TOPAZ	4 CIL, 2.3 L	1994	-	1994
------	-------	--------------	------	---	------

**38169**



ACURA	CL	V-6, 3.0 L	1998	-	1999
ACURA	CL	V-6, 3.2 L	2001	-	2003
ACURA	TL	V-6, 3.2 L	1999	-	2003
HONDA	ACCORD	V-6, 3.0 L	1998	-	2002
HONDA	ODYSSEY	V-6, 3.5 L	1999	-	2000

**38171**



FORD	ESCORT	4 CIL, 2.0 L	1997	-	2002
------	--------	--------------	------	---	------

**38172**



CHEVROLET	EXPRESS	V-8, 6.6 L	2007	-	2007
GMC	SAVANA	V-8, 6.6 L	2006	-	2007
GMC	SIERRA SERIES PICKUP	V-8, 6.6 L	2002	-	2007
HUMMER	H1	V-8, 6.6 L	2006	-	2007

CHRYSLER	CROSSFIRE	V-6, 3.2 L	2004	-	2005
MERCEDES BE	C240	V-6, 2.6 L	2001	-	2005
MERCEDES BE	C280	V-6, 2.8 L	1998	-	2000
MERCEDES BE	C320	V-6, 3.2 L	2001	-	2005
MERCEDES BE	C43	V-8, 4.3 L	1999	-	2000
MERCEDES BE	CL500	V-8, 5.0 L	2000	-	2005
MERCEDES BE	CL55	V-8, 5.5 L	2001	-	2006
MERCEDES BE	CLK320	V-6, 3.2 L	2001	-	2005
MERCEDES BE	CLK430	V-8, 4.3 L	2000	-	2003
MERCEDES BE	CLK500	V-8, 5.0 L	2003	-	2005
MERCEDES BE	CLK55	V-8, 5.5 L	2001	-	2006
MERCEDES BE	E320	V-6, 3.2 L	2001	-	2006
MERCEDES BE	E430	V-8, 4.3 L	2001	-	2001
MERCEDES BE	E430	V-8, 4.3 L	2002	-	2002
MERCEDES BE	E500	V-8, 5.0 L	2003	-	2005
MERCEDES BE	E55	V-8, 5.5 L	2001	-	2002
MERCEDES BE	G500	V-8, 5.0 L	2002	-	2005
MERCEDES BE	G55	V-8, 5.5 L	2003	-	2005
MERCEDES BE	ML320	V-6, 3.2 L	2001	-	2003
MERCEDES BE	ML350	V-6, 3.7 L	2003	-	2005
MERCEDES BE	ML430	V-8, 4.3 L	2001	-	2001
MERCEDES BE	ML500	V-8, 5.0 L	2002	-	2005
MERCEDES BE	ML55	V-8, 5.5 L	2001	-	2003
MERCEDES BE	S430	V-8, 4.3 L	2001	-	2005
MERCEDES BE	S500	V-8, 5.0 L	2001	-	2005
MERCEDES BE	S55	V-8, 5.5 L	2001	-	2005
MERCEDES BE	SL500	V-8, 5.0 L	2001	-	2005
MERCEDES BE	SL55	V-8, 5.5 L	2003	-	2006
MERCEDES BE	SLK320	V-6, 3.2 L	2001	-	2004

**38175**



VOLKSWAGEN	CORRADO	V-6, 2.8 L	1995	-	1995
VOLKSWAGEN	GOLF	V-6, 2.8 L	1995	-	2000
VOLKSWAGEN	GOLF	V-6, 2.8 L	1997	-	2003
VOLKSWAGEN	GOLF GLX VR6	V-6, 2.8 L	1998	-	2000
VOLKSWAGEN	GTI	V-6, 2.8 L	1999	-	2001
VOLKSWAGEN	JETTA	V-6, 2.8 L	1995	-	2004
VOLKSWAGEN	PASSAT	V-6, 2.8 L	1995	-	1997



**38176**

CHRYSLER	PT CRUISER	4 CIL, 2.4 L	2000 - 2010
DODGE	NEON	4 CIL, 2.4 L	2004 - 2004



**38177**

CHEVROLET	CAPTIVA	4 CIL, 2.4 L	2008 - 2010
CHEVROLET	CAVALIER	4 CIL, 2.2 L	2002 - 2005
CHEVROLET	CLASSIC	4 CIL, 2.2 L	2005 - 2005
CHEVROLET	COBALT	4 CIL, 2.2 L	2005 - 2007
CHEVROLET	COBALT	4 CIL, 2.4 L	2006 - 2007
CHEVROLET	HHR	4 CIL, 2.4 L	2006 - 2010
CHEVROLET	MALIBU	4 CIL, 2.2 L	2004 - 2007
CHEVROLET	MALIBU	4 CIL, 2.4 L	2008 - 2010
CHEVROLET	VECTRA	4 CIL, 2.2 L	2003 - 2005
CHEVROLET	VECTRA	V-6, 2.8 L	2007 - 2008
CHEVROLET	VECTRA	V-6, 3.2 L	2003 - 2006
PONTIAC	G4	4 CIL, 2.2 L	2006 - 2006
PONTIAC	G4	4 CIL, 2.4 L	2006 - 2006
PONTIAC	G5	4 CIL, 2.2 L	2007 - 2008
PONTIAC	G5	4 CIL, 2.4 L	2007 - 2008
PONTIAC	G6	4 CIL, 2.4 L	2006 - 2007
PONTIAC	GRAND AM	4 CIL, 2.2 L	2002 - 2003
PONTIAC	SOLSTICE	4 CIL, 2.0 L	2007 - 2007
PONTIAC	SOLSTICE	4 CIL, 2.4 L	2006 - 2008
PONTIAC	SUNFIRE	4 CIL, 2.2 L	2002 - 2005
SAAB	9 - 3	4 CIL, 2.0 L	2003 - 2007
SAAB	9 - 3	4 CIL, 2.0 L	2003 - 2006
SATURN	ION	4 CIL, 2.2 L	2003 - 2007
SATURN	ION	4 CIL, 2.4 L	2006 - 2007
SATURN	L-SERIES	4 CIL, 2.2 L	2000 - 2004
SATURN	SKY	4 CIL, 2.4 L	2007 - 2007
SATURN	VUE	4 CIL, 2.2 L	2002 - 2007

**38178**



CHEVROLET	COLORADO	4 CIL, 2.8 L	2004 - 2004
CHEVROLET	COLORADO	4 CIL, 2.8 L	2005 - 2006
CHEVROLET	COLORADO	4 CIL, 2.9 L	2007 - 2010
CHEVROLET	COLORADO	5 CIL, 3.5 L	2004 - 2005
CHEVROLET	COLORADO	5 CIL, 3.5 L	2006 - 2006
CHEVROLET	COLORADO	5 CIL, 3.7 L	2007 - 2010
CHEVROLET	TRAILBLAZER	6 CIL, 4.2 L	2002 - 2007
GMC	CANYON	4 CIL, 2.8 L	2004 - 2006
GMC	CANYON	4 CIL, 2.9 L	2007 - 2007
GMC	CANYON	5 CIL, 3.5 L	2004 - 2006
GMC	CANYON	5 CIL, 3.7 L	2007 - 2010
GMC	ENVOY	6 CIL, 4.2 L	2002 - 2007
HUMMER	H3	5 CIL, 3.5 L	2006 - 2007
HUMMER	H3	5 CIL, 3.7 L	2007 - 2007
HUMMER	H3	5 CIL, 3.7 L	2008 - 2010

SAAB	9-7X	6 CIL, 4.2 L	2005 - 2007
------	------	--------------	-------------

**38179**



CADILLAC	CATERA	V-6, 3.0 L	1998 - 2001
CADILLAC	CTS	V-6, 3.2 L	2003 - 2004
SAAB	9 - 5	V-6, 3.0 L	2000 - 2003
SAAB	9 - 5	V-6, 3.0 L	2002 - 2002
SATURN	L-SERIES	V-6, 3.0 L	2000 - 2005
SATURN	VUE	V-6, 3.0 L	2002 - 2003

**38180**



DODGE	RAM SERIES PICKUP	V-10, 8.0 L	1995 - 1998
DODGE	RAM SERIES PICKUP	V-10, 8.0 L	1999 - 2000
DODGE	RAM SERIES PICKUP	V-8, 5.9 L	1997 - 2001
DODGE	RAM WAGON 3500 SLT	V-8, 5.9 L	2000 - 2000

**38181**



FORD	TAURUS	V-6, 3.0 L	2000 - 2000
MERCURY	SABLE / TAURUS	V-6, 3.0 L	1998 - 2000

**38182**



FORD	MUSTANG	V-8, 5.0 L	1994 - 1995
------	---------	------------	-------------

**38185**



CHRYSLER	TOWN & COUNTRY	V-6, 3.8 L	2005 - 2007
CHRYSLER	TOWN & COUNTRY VAN	V-6, 3.3 L	2001 - 2006
CHRYSLER	TOWN & COUNTRY VAN	V-6, 3.8 L	2001 - 2006
CHRYSLER	VOYAGER	V-6, 3.3 L	2001 - 2007
DODGE	CARAVAN	V-6, 3.3 L	2001 - 2003
DODGE	CARAVAN	V-6, 3.3 L	2002 - 2007
DODGE	GRAND CARAVAN	V-6, 3.3 L	2001 - 2006



DODGE	GRAND CARAVAN	V-6, 3.8 L	2001 - 2006
JEEP	LIBERTY	4 CIL, 2.4 L	2002 - 2005
JEEP	WRANGLER	4 CIL, 2.4 L	2003 - 2006

**38186**



VOLVO	C70	5 CIL, 2.4 L	2004 - 2004
VOLVO	S40	4 CIL, 1.9 L	2002 - 2004
VOLVO	S60	5 CIL, 2.5 L	2004 - 2006
VOLVO	S80	5 CIL, 2.5 L	2005 - 2006
VOLVO	S80	6 CIL, 2.9 L	2002 - 2005
VOLVO	XC90	5 CIL, 2.5 L	2003 - 2006

**38191**



FORD	ESCAPE	V-6, 3.0 L	2001 - 2004
MERCURY	SABLE / TAURUS	V-6, 3.0 L	2003 - 2005

**38187**



FORD	EXCURSION	V-8, 7.3 L	2000 - 2003
FORD	F-450 SUPER DUTY	V-8, 7.3 L	2002 - 2003
FORD	SUPER DUTY PICKUP	V-8, 7.3 L	1999 - 2002
FORD	SUPER DUTY PICKUP	V-8, 7.3 L	2003 - 2003

**38192**



CHEVROLET	S SERIES PICKUP	4 CIL, 2.2 L	1994 - 1997
CHEVROLET	S-10	4 CIL, 2.2 L	1994 - 1996
CHEVROLET	S-10	4 CIL, 2.2 L	1997 - 1997

**38188**



VOLKSWAGEN	BEETLE	4 CIL, 1.9 L	1998 - 2003
VOLKSWAGEN	GOLF	4 CIL, 1.9 L	1999 - 2003
VOLKSWAGEN	JETTA	4 CIL, 1.9 L	1999 - 2004
VOLKSWAGEN	JETTA	4 CIL, 1.9 L DIESE2000	2000 - 2004

**38193**



FORD	CONTOUR	4 CIL, 2.0 L	1998 - 2000
FORD	ESCAPE	4 CIL, 2.0 L	2001 - 2002
FORD	ESCAPE	4 CIL, 2.0 L	2003 - 2004
FORD	FOCUS	4 CIL, 2.0 L	2000 - 2003
FORD	FOCUS	4 CIL, 2.0 L	2002 - 2002
MERCURY	MYSTIQUE	4 CIL, 2.0 L	1998 - 2000

**38189**



AUDI	A4	V-6, 2.8 L	1998 - 1998
AUDI	A4	V-6, 2.8 L	1999 - 2000
AUDI	A4	V-6, 2.8 L	2001 - 2001
AUDI	A6	V-6, 2.7 L	2000 - 2000
AUDI	A6	V-6, 2.7 L	2001 - 2004
AUDI	A6	V-6, 2.8 L	1998 - 2001
AUDI	A6 QUATTRO	V-6, 2.7 L	2000 - 2000
AUDI	A6 QUATTRO	V-6, 2.8 L	1998 - 1999
AUDI	A6 QUATTRO	V-6, 2.8 L	2000 - 2002
AUDI	ALLROAD QUATTRO	V-6, 2.7 L	2001 - 2001
AUDI	ALLROAD QUATTRO	V-6, 2.7 L	2002 - 2006
AUDI	CABRIOLET	V-6, 2.8 L	1998 - 1998
AUDI	S4	V-6, 2.7 L	2000 - 2002
AUDI	S4 QUATTRO	V-6, 2.7 L	2000 - 2000
AUDI	S4 QUATTRO	V-6, 2.7 L	2001 - 2002
VOLKSWAGEN	PASSAT	V-6, 2.8 L	1998 - 2005
VOLKSWAGEN	PASSAT	V-6, 3.2 L	2005 - 2005

**38194**



FORD	CROWN VICTORIA	V-8, 4.6 L	2001 - 2004
FORD	GRAND MARQUIS	V-8, 4.6 L	2001 - 2006
FORD	MUSTANG	V-8, 4.6 L	2000 - 2004
LINCOLN	TOWN CAR	V-8, 4.6 L	2000 - 2006
MERCURY	GRAND MARQUIS	V-8, 4.6 L	2000 - 2005
MERCURY	GRAND MARQUIS	V-8, 4.6 L	2006 - 2006

**38190**



VOLVO	C70	5 CIL, 2.3 L	2004 - 2004
-------	-----	--------------	-------------

CHEVROLET	CORVETTE	V-8, 5.7 L	1997 - 2004
-----------	----------	------------	-------------



**38195**

CHEVROLET	MONZA	4 CIL, 1.6 L	1994	-	2004
CHEVROLET	OPTRA	4 CIL, 2.0 L	2004	-	2005
CHEVROLET	OPTRA	4 CIL, 2.0 L	2006	-	2010
CHEVROLET	TIGRA	4 CIL, 1.6 L	1999	-	1999
CHEVROLET	TIGRA	4 CIL, 1.6 L	2000	-	2000
DAEWOO	LEGANZA	4 CIL, 2.2 L	1999	-	2002
DAEWOO	NUBIRA	4 CIL, 2.0 L	1999	-	2002
SUZUKI	FORENZA	4 CIL, 2.0 L	2004	-	2007
SUZUKI	RENO	4 CIL, 2.0 L	2005	-	2007

CHEVROLET	CAMARO	V-8, 5.7 L	1998	-	2002
PONTIAC	FIREBIRD	V-8, 5.7 L	1998	-	2002



**38196**



**38201**

CHEVROLET	CAMARO	V-8, 5.7 L	1998	-	2002
CHEVROLET	CORVETTE	V-8, 5.7 L	1997	-	2004
PONTIAC	FIREBIRD	V-8, 5.7 L	1998	-	2002



**38197**

BMW	318I	V-6, 2.8 L	1998	-	2000
BMW	320I	6 CIL, 2.2 L	2001	-	2005
BMW	323CI	6 CIL, 2.5 L	2000	-	2000
BMW	323I	6 CIL, 2.5 L	1998	-	2000
BMW	323IS	6 CIL, 2.5 L	1998	-	1999
BMW	325CI	6 CIL, 2.5 L	2001	-	2005
BMW	325I	6 CIL, 2.5 L	2001	-	2005
BMW	325XI	6 CIL, 2.5 L	2001	-	2003
BMW	325XI	6 CIL, 2.5 L	2004	-	2005
BMW	328CI	6 CIL, 2.8 L	2000	-	2000
BMW	328I	6 CIL, 2.8 L	1998	-	2000
BMW	328I	V-6, 2.8 L	2000	-	2000
BMW	328IS	6 CIL, 2.8 L	1998	-	1999
BMW	330CI	6 CIL, 3.0 L	2001	-	2003
BMW	330CI	6 CIL, 3.0 L	2004	-	2006
BMW	330I	6 CIL, 3.0 L	2001	-	2005
BMW	330XI	6 CIL, 3.0 L	2001	-	2005
BMW	330XI	6 CIL, 3.0 L	2002	-	2004
BMW	525I	6 CIL, 2.5 L	2001	-	2005
BMW	528I	6 CIL, 2.8 L	1998	-	2000
BMW	528I	V-6, 2.8 L	1998	-	2000
BMW	528I	V-6, 2.8 L	1999	-	1999
BMW	530I	6 CIL, 3.0 L	2001	-	2005
BMW	530I	6 CIL, 3.0 L	2002	-	2002
BMW	M3	6 CIL, 3.2 L	1999	-	1999
BMW	M3	6 CIL, 3.2 L	2001	-	2001
BMW	X3	6 CIL, 2.5 L	2004	-	2006
BMW	X3	6 CIL, 3.0 L	2004	-	2004
BMW	X3	6 CIL, 3.0 L	2005	-	2006
BMW	X5	6 CIL, 3.0 L	2001	-	2004
BMW	X5	6 CIL, 3.0 L	2005	-	2005
BMW	X5	6 CIL, 3.0 L	2006	-	2006
BMW	X5	V-6, 3.0 L	2004	-	2004
BMW	Z3	6 CIL, 2.5 L	1999	-	2002
BMW	Z3	6 CIL, 2.8 L	1998	-	1998
BMW	Z3	6 CIL, 2.8 L	1999	-	2000
BMW	Z3	6 CIL, 3.0 L	2001	-	2002
BMW	Z3	6 CIL, 3.2 L	2000	-	2001
BMW	Z4	6 CIL, 2.5 L	2003	-	2005
BMW	Z4	6 CIL, 2.5 L	2004	-	2004
BMW	Z4	6 CIL, 3.0 L	2003	-	2005
BMW	Z4	6 CIL, 3.0 L	2004	-	2004
BMW	Z4	V-6, 2.5 L	2004	-	2004
BMW	Z4	V-6, 2.5 L	2005	-	2006
BMW	Z4	V-6, 3.0 L	2004	-	2004

CADILLAC	DEVILLE	V-8, 4.6 L	1998	-	2005
CADILLAC	DTS	V-8, 4.6 L	2006	-	2007
CADILLAC	EL DORADO	V-8, 4.6 L	1998	-	2002
CADILLAC	SEVILLE	V-8, 4.6 L	1998	-	2004

**38198**



CHEVROLET	LUMINA	V-6, 3.4 L	1991	-	1992
CHEVROLET	LUMINA	V-6, 3.4 L	1993	-	1997
PONTIAC	GRAND PRIX	V-6, 3.4 L	1995	-	1996

**38200**



CHEVROLET	ASTRA	4 CIL, 2.0 L	2007	-	2008
CHEVROLET	CHEVY	4 CIL, 1.6 L	1994	-	2001
CHEVROLET	CHEVY	4 CIL, 1.6 L	2009	-	2010
CHEVROLET	CHEVY C2	4 CIL, 1.6 L	2004	-	2008
CHEVROLET	CHEVY C2 SEDAN	4 CIL, 1.6 L	2004	-	2008
CHEVROLET	CHEVY JOY	4 CIL, 1.6 L	1994	-	2003
CHEVROLET	CHEVY PICK-UP	4 CIL, 1.6 L	2002	-	2006
CHEVROLET	CHEVY POP	4 CIL, 1.6 L	1994	-	2003
CHEVROLET	CHEVY SWING	4 CIL, 1.6 L	1994	-	2003

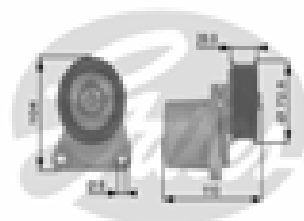

**38204**

FORD	ECOSPORT	4 CIL, 2.0 L	2003	-	2010
------	----------	--------------	------	---	------



FORD MONDEO 4 CIL, 2.0 L 2003 - 2006

**38207**



AUDI A4 4 CIL, 1.8 L 2003 - 2006  
 AUDI A4 4 CIL, 1.8 L 2004 - 2004  
 AUDI A4 4 CIL, 2.0 L 2005 - 2006  
 AUDI A4 4 CIL, 2.0 L 2007 - 2007

**38216**



TOYOTA CAMRY 4 CIL, 2.4 L 2002 - 2002  
 TOYOTA CAMRY 4 CIL, 2.4 L 2003 - 2006  
 TOYOTA HIGHLANDER 4 CIL, 2.4 L 2001 - 2006  
 TOYOTA RAV 4 4 CIL, 2.0 L 2001 - 2002  
 TOYOTA RAV 4 4 CIL, 2.0 L 2003 - 2003  
 TOYOTA RAV 4 4 CIL, 2.4 L 2004 - 2007  
 TOYOTA RAV-4 4 CIL, 2.4 L 2007 - 2008  
 TOYOTA SOLARA 4 CIL, 2.4 L 2002 - 2007

**38218**



BMW 540I V-8, 4.4 L 1998 - 2001  
 BMW 540I V-8, 4.4 L 2002 - 2003  
 BMW 740I V-8, 4.4 L 1998 - 2001  
 BMW 740IL V-8, 4.4 L 1998 - 2001  
 BMW M5 V-8, 5.0 L 2000 - 2001  
 BMW X5 V-8, 4.4 L 2000 - 2000  
 BMW X5 V-8, 4.4 L 2001 - 2001  
 BMW X5 V-8, 4.4 L 2002 - 2003  
 BMW X5 V-8, 4.6 L 2002 - 2002  
 BMW X5 V-8, 4.6 L 2003 - 2003

**38219**



BMW 540I V-8, 4.4 L 1998 - 2001  
 BMW 540I V-8, 4.4 L 2002 - 2003  
 BMW 740I V-8, 4.4 L 1998 - 2001  
 BMW 740IL V-8, 4.4 L 1998 - 2001  
 BMW M5 V-8, 5.0 L 2000 - 2001  
 BMW X5 V-8, 4.4 L 2000 - 2000  
 BMW X5 V-8, 4.4 L 2001 - 2001  
 BMW X5 V-8, 4.4 L 2002 - 2003  
 BMW X5 V-8, 4.6 L 2002 - 2002

BMW X5 V-8, 4.6 L 2003 - 2003

**38220**



BMW 323I 6 CIL, 2.5 L 1998 - 1999  
 BMW 323IS 6 CIL, 2.5 L 1998 - 1999  
 BMW 528I 6 CIL, 2.8 L 1998 - 1998  
 BMW Z3 6 CIL, 2.5 L 1999 - 2000  
 BMW Z3 6 CIL, 2.8 L 1998 - 1998  
 BMW Z3 6 CIL, 2.8 L 1999 - 2000

**38221**



BMW 320I 6 CIL, 2.2 L 2001 - 2005  
 BMW 323CI 6 CIL, 2.5 L 2000 - 2000  
 BMW 323I 6 CIL, 2.5 L 1998 - 2000  
 BMW 323IS 6 CIL, 2.5 L 1998 - 1999  
 BMW 325CI 6 CIL, 2.5 L 2001 - 2005  
 BMW 325I 6 CIL, 2.5 L 2001 - 2005  
 BMW 325XI 6 CIL, 2.5 L 2001 - 2003  
 BMW 325XI 6 CIL, 2.5 L 2004 - 2005  
 BMW 328CI 6 CIL, 2.8 L 2000 - 2000  
 BMW 328I 6 CIL, 2.8 L 1998 - 2000  
 BMW 328IS 6 CIL, 2.8 L 1998 - 1999  
 BMW 330CI 6 CIL, 3.0 L 2001 - 2003  
 BMW 330CI 6 CIL, 3.0 L 2004 - 2005  
 BMW 330I 6 CIL, 3.0 L 2001 - 2005  
 BMW 330XI 6 CIL, 3.0 L 2001 - 2005  
 BMW 330XI 6 CIL, 3.0 L 2002 - 2004  
 BMW 525I 6 CIL, 2.5 L 2001 - 2005  
 BMW 528I 6 CIL, 2.8 L 1998 - 2000  
 BMW 530I 6 CIL, 3.0 L 2001 - 2005  
 BMW 530I 6 CIL, 3.0 L 2002 - 2002  
 BMW M3 6 CIL, 3.2 L 1998 - 2005  
 BMW M3 6 CIL, 3.2 L 2001 - 2002  
 BMW X3 6 CIL, 2.5 L 2004 - 2006  
 BMW X3 6 CIL, 3.0 L 2004 - 2004  
 BMW X3 6 CIL, 3.0 L 2005 - 2006  
 BMW X5 6 CIL, 3.0 L 2001 - 2004  
 BMW X5 6 CIL, 3.0 L 2005 - 2005  
 BMW X5 6 CIL, 3.0 L 2006 - 2006  
 BMW X5 V-6, 3.0 L 2004 - 2004  
 BMW Z3 6 CIL, 2.5 L 1999 - 2000  
 BMW Z3 6 CIL, 2.8 L 1998 - 1998  
 BMW Z3 6 CIL, 2.8 L 1999 - 2000  
 BMW Z3 6 CIL, 3.2 L 1998 - 1998  
 BMW Z3 6 CIL, 3.2 L 1999 - 2002

**38223**



BMW 318I 4 CIL, 1.9 L 1998 - 1998  
 BMW 318I 4 CIL, 1.9 L 1999 - 1999  
 BMW 318IS 4 CIL, 1.9 L 1998 - 1999





BMW	318TI	4 CIL, 1.9 L	1998	-	1999
BMW	Z3	4 CIL, 1.9 L	1998	-	1998

**38228**



**38224**

BMW	318I	V-6, 2.8 L	1999	-	1999
BMW	323CI	6 CIL, 2.5 L	2000	-	2000
BMW	323I	6 CIL, 2.5 L	1998	-	2000
BMW	323IS	6 CIL, 2.5 L	1998	-	1999
BMW	325CI	6 CIL, 2.5 L	2001	-	2002
BMW	325I	6 CIL, 2.5 L	2001	-	2002
BMW	325XI	6 CIL, 2.5 L	2001	-	2002
BMW	328CI	6 CIL, 2.8 L	2000	-	2000
BMW	328I	6 CIL, 2.8 L	1998	-	2000
BMW	328I	V-6, 2.8 L	2000	-	2000
BMW	328IS	6 CIL, 2.8 L	1998	-	1999
BMW	330CI	6 CIL, 3.0 L	2001	-	2002
BMW	330I	6 CIL, 3.0 L	2001	-	2002
BMW	330XI	6 CIL, 3.0 L	2001	-	2001
BMW	330XI	6 CIL, 3.0 L	2002	-	2002
BMW	525I	6 CIL, 2.5 L	2001	-	2002
BMW	528I	6 CIL, 2.8 L	1999	-	2000
BMW	528I	V-6, 2.8 L	1999	-	1999
BMW	528I	V-6, 2.8 L	2000	-	2000
BMW	530I	6 CIL, 3.0 L	2001	-	2001
BMW	530I	6 CIL, 3.0 L	2002	-	2002
BMW	M3	6 CIL, 3.2 L	1999	-	2003
BMW	M3	6 CIL, 3.2 L	2001	-	2002
BMW	X5	6 CIL, 3.0 L	2001	-	2002
BMW	Z3	6 CIL, 2.5 L	2000	-	2002
BMW	Z3	6 CIL, 2.8 L	2000	-	2000
BMW	Z3	6 CIL, 3.0 L	2001	-	2002
BMW	Z3	6 CIL, 3.2 L	2000	-	2002

BMW	318I	V-6, 2.8 L	2000	-	2000
-----	------	------------	------	---	------

**38239**

FORD	E SERIES VAN	V-8, 4.6 L	2005	-	2005
------	--------------	------------	------	---	------

**38245**



LAND ROVER	DISCOVERY	V-8, 4.0 L	1999	-	2002
LAND ROVER	DISCOVERY SERIES II	V-8, 4.0 L	1999	-	2001
LAND ROVER	RANGE ROVER	V-8, 4.0 L	1996	-	1997
LAND ROVER	RANGE ROVER	V-8, 4.0 L	1998	-	2000
LAND ROVER	RANGE ROVER	V-8, 4.6 L	1996	-	1997
LAND ROVER	RANGE ROVER	V-8, 4.6 L	1998	-	2002

**38246**



LAND ROVER	DEFENDER 90	V-8, 4.0 L	1997	-	1997
LAND ROVER	DISCOVERY	V-8, 3.9 L	1995	-	1995
LAND ROVER	DISCOVERY	V-8, 4.0 L	1999	-	1999
LAND ROVER	RANGE ROVER	V-8, 4.2 L	1995	-	1995

**38247**



CHEVROLET	CAVALIER	4 CIL, 2.4 L	1999	-	1999
CHEVROLET	CAVALIER	4 CIL, 2.4 L	2000	-	2002
CHEVROLET	CAVALIER Z24	4 CIL, 2.4 L	1998	-	2002
CHEVROLET	MALIBU	4 CIL, 2.4 L	1999	-	1999
PONTIAC	GRAND AM	4 CIL, 2.4 L	2001	-	2001
PONTIAC	SUNFIRE	4 CIL, 2.4 L	1999	-	2002

MERCEDES BE	SLK230	4 CIL, 2.3 L	2001	-	2004
-------------	--------	--------------	------	---	------

**38226**



SAAB	9 - 3	4 CIL, 2.0 L	2000	-	2003
SAAB	9 - 3	4 CIL, 2.0 L	2002	-	2002
SAAB	9 - 3	4 CIL, 2.3 L	2000	-	2002
SAAB	9 - 3	4 CIL, 2.3 L	2001	-	2002
SAAB	9 - 5	4 CIL, 2.3 L	2000	-	2006
SAAB	9 - 5	4 CIL, 2.3 L	2002	-	2007
SAAB	9 - 5	V-6, 3.0 L	2003	-	2003



**38249**

MERCURY COUGAR V-8, 5.0 L 1991 - 1992



**38250**

FORD CONTOUR V-6, 2.5 L 1995 - 2000  
MERCURY MYSTIQUE V-6, 2.5 L 1995 - 2000



**38251**

LINCOLN CONTINENTAL V-8, 4.6 L 1997 - 2002



**38257**

FORD EXCURSION V-8, 6.0 L 2003 - 2005  
FORD SUPER DUTY PICKUP V-8, 6.0 L 2003 - 2005  
FORD SUPER DUTY VAN V-8, 6.0 L 2004 - 2006



**38258**

CHEVROLET C y K SERIES PICKUP V-8, 8.1 L 2001 - 2002  
CHEVROLET EXPRESS V-8, 8.1 L 2001 - 2002  
GMC C y K SERIES PICKUP V-8, 8.1 L 2001 - 2002  
GMC SAVANA V-8, 8.1 L 2001 - 2002



**38259**

CHEVROLET AVALANCHE V-8, 8.1 L 2002 - 2002  
CHEVROLET AVALANCHE V-8, 8.1 L 2003 - 2006  
CHEVROLET SILVERADO PICKUP V-8, 8.1 L 2001 - 2007  
CHEVROLET SUBURBAN V-8, 8.1 L 2001 - 2006  
GMC SIERRA SERIES PICKUP V-8, 8.1 L 2001 - 2007  
GMC YUKON V-8, 8.1 L 2001 - 2006



**38260**

CHEVROLET AVALANCHE V-8, 8.1 L 2002 - 2002  
CHEVROLET AVALANCHE V-8, 8.1 L 2003 - 2006  
CHEVROLET SILVERADO PICKUP V-8, 8.1 L 2001 - 2007  
CHEVROLET SUBURBAN V-8, 8.1 L 2001 - 2006  
GMC SIERRA SERIES PICKUP V-8, 8.1 L 2001 - 2007  
GMC YUKON V-8, 8.1 L 2001 - 2006



**38266**

ACURA SLX V-6, 3.5 L 1999 - 1999  
HONDA PASSPORT V-6, 3.2 L 1998 - 2001



**38268**

OLDSMOBILE EIGHTY EIGHT V-6, 3.8 L 1995 - 1995  
OLDSMOBILE NINETY EIGHT V-6, 3.8 L 1995 - 1995  
PONTIAC BONNEVILLE V-6, 3.8 L 1994 - 1995



**38269**

OLDSMOBILE EIGHTY EIGHT V-6, 3.8 L 1995 - 1995  
OLDSMOBILE NINETY EIGHT V-6, 3.8 L 1995 - 1995  
PONTIAC BONNEVILLE V-6, 3.8 L 1995 - 1995



### 38270



FORD	E SERIES VAN	V-8, 7.3 L	1994	-	1995
FORD	F SERIES PICKUP	V-8, 7.3 L	1994	-	1994
FORD	SUPER DUTY PICKUP	V-8, 7.3 L	1994	-	1994

### 38271



CHEVROLET	IMPALA	V-6, 3.8 L	2000	-	2005
CHEVROLET	IMPALA	V-6, 3.8 L	2003	-	2003
PONTIAC	BONNEVILLE	V-6, 3.8 L	2003	-	2005
PONTIAC	GRAND PRIX	V-6, 3.8 L	2003	-	2005

### 38273



CHEVROLET	EPICA	6 CIL, 2.5 L	2004	-	2006
SUZUKI	VERONA	6 CIL, 2.5 L	2004	-	2006

### 38274



FORD	E SERIES VAN	V-8, 4.6 L	2002	-	2010
FORD	E SERIES VAN	V-8, 5.4 L	2002	-	2010
FORD	EXCURSION	V-10, 6.8 L	2002	-	2005
FORD	EXCURSION	V-8, 5.4 L	2003	-	2005
FORD	EXPEDITION	V-8, 4.6 L	2002	-	2004
FORD	EXPEDITION	V-8, 5.4 L	2002	-	2010
FORD	EXPEDITION	V-8, 5.4 L	2005	-	2005
FORD	EXPLORER	V-8, 4.6 L	2002	-	2010
FORD	EXPLORER SPORT TRAC	V-8, 4.6 L	2007	-	2010
FORD	F SERIES PICKUP	V-8, 4.6 L	2002	-	2006
FORD	F SERIES PICKUP	V-8, 5.4 L	2002	-	2002
FORD	F SERIES PICKUP	V-8, 5.4 L	2003	-	2006
FORD	F-150	V-8, 4.6 L	2008	-	2010
FORD	F-250	V-8, 4.6 L	2002	-	2007
FORD	F-350 SUPER DUTY	V-8, 5.4 L	2002	-	2010
FORD	F-450 SUPER DUTY	V-10, 6.8 L	2007	-	2010
FORD	F-550 SUPER DUTY	V-10, 6.8 L	2008	-	2010
FORD	GT	V-8, 5.4 L	2005	-	2006
FORD	LOBO	V-8, 4.6 L	2002	-	2010
FORD	LOBO	V-8, 5.4 L	2005	-	2010
FORD	MUSTANG	V-8, 4.6 L	2005	-	2010
FORD	SUPER DUTY PICKUP	V-10, 6.8 L	2002	-	2003
FORD	SUPER DUTY PICKUP	V-10, 6.8 L	2004	-	2006
FORD	SUPER DUTY PICKUP	V-8, 5.4 L	2002	-	2003

FORD	SUPER DUTY PICKUP	V-8, 5.4 L	2004	-	2006
FORD	SUPER DUTY VAN	V-10, 6.8 L	2002	-	2002
FORD	SUPER DUTY VAN	V-10, 6.8 L	2003	-	2004
FORD	SUPER DUTY VAN	V-8, 4.6 L	2003	-	2003
FORD	SUPER DUTY VAN	V-8, 4.6 L	2004	-	2004
FORD	SUPER DUTY VAN	V-8, 5.4 L	2002	-	2002
FORD	SUPER DUTY VAN	V-8, 5.4 L	2003	-	2005
LINCOLN	AVIATOR	V-8, 4.6 L	2003	-	2005
LINCOLN	AVIATOR	V-8, 4.6 L	2003	-	2005
LINCOLN	BLACKWOOD	V-8, 5.4 L	2002	-	2002
LINCOLN	MARK LT	V-8, 5.4 L	2007	-	2008
LINCOLN	NAVIGATOR	V-8, 5.4 L	2002	-	2009
MERCURY	MOUNTAINEER	V-8, 4.6 L	2002	-	2005

### 38275



FORD	FOCUS	4 CIL, 2.0 L	2000	-	2004
------	-------	--------------	------	---	------

### 38276



FORD	CONTOUR	V-6, 2.5 L	1996	-	2000
FORD	ESCAPE	V-6, 3.0 L	2001	-	2007

### 38277

DODGE	NEON	4 CIL, 2.0 L	2004	-	2006
-------	------	--------------	------	---	------

### 38278



ACURA	RDX	4 CIL, 2.3 L	2006	-	2010
ACURA	TSX	4 CIL, 2.4 L	2004	-	2006
HONDA	ACCORD	4 CIL, 2.4 L	2003	-	2007
HONDA	ACCORD	4 CIL, 2.4 L	2004	-	2004
HONDA	CR-V	4 CIL, 2.4 L	2003	-	2003
HONDA	CR-V	4 CIL, 2.4 L	2004	-	2009
HONDA	ELEMENT	4 CIL, 2.4 L	2003	-	2005



**38279**

FORD	ESCAPE	V-6, 3.0 L	2005	-	2009
FORD	FIVE HUNDRED	V-6, 3.0 L	2005	-	2007
FORD	FREESTYLE	V-6, 3.0 L	2005	-	2005
FORD	FUSION	V-6, 3.0 L	2006	-	2006
FORD	FUSION	V-6, 3.0 L	2007	-	2009
FORD	THUNDERBIRD	V-8, 3.9 L	2002	-	2003
JAGUAR	S-TYPE	V-8, 4.0 L	2000	-	2002
JAGUAR	X-TYPE	V-6, 2.5 L	2002	-	2005
JAGUAR	X-TYPE	V-6, 3.0 L	2002	-	2005
LINCOLN	LS	V-6, 3.0 L	2000	-	2001
LINCOLN	LS	V-6, 3.0 L	2003	-	2005
LINCOLN	LS	V-8, 3.9 L	2000	-	2006
LINCOLN	ZEPHYR	V-6, 3.0 L	2006	-	2006
MAZDA	TRIBUTE	V-6, 3.0 L	2006	-	2006
MERCURY	MARINER	V-6, 3.0 L	2005	-	2006
MERCURY	MARINER	V-6, 3.0 L	2007	-	2009
MERCURY	MILAN	V-6, 3.0 L	2006	-	2009
MERCURY	MONTEGO	V-6, 3.0 L	2005	-	2006



**38288**

LINCOLN	TOWN CAR	V-8, 4.6 L	1991	-	1991
---------	----------	------------	------	---	------

**38289**



CHEVROLET	CAMARO	V-6, 3.8 L	1998	-	2002
CHEVROLET	LUMINA	V-6, 3.8 L	1999	-	1999
OLDSMOBILE	EIGHTY EIGHT	V-6, 3.8 L	1999	-	1999
OLDSMOBILE	LSS	V-6, 3.8 L	1999	-	1999
PONTIAC	FIREBIRD	V-6, 3.8 L	1998	-	2002



**38284**

NISSAN	ALTIMA	4 CIL, 2.4 L	2004	-	2004
NISSAN	ALTIMA	4 CIL, 2.5 L	2002	-	2002
NISSAN	ALTIMA	4 CIL, 2.5 L	2003	-	2006
NISSAN	SENTRA	4 CIL, 2.5 L	2002	-	2002
NISSAN	SENTRA	4 CIL, 2.5 L	2003	-	2006



**38291**

FORD	F-150	V-6, 4.2 L	2003	-	2006
------	-------	------------	------	---	------

**38297**



FORD	THUNDERBIRD	V-6, 3.8 L	1994	-	1994
FORD	THUNDERBIRD	V-6, 3.8 L	1995	-	1995
MERCURY	COUGAR	V-6, 3.8 L	1990	-	1990
MERCURY	COUGAR LS	V-6, 3.8 L	1990	-	1990

**38298**



FORD	THUNDERBIRD	V-6, 3.8 L	1994	-	1994
FORD	THUNDERBIRD	V-6, 3.8 L	1995	-	1995



**38285**

DODGE	RAM 4000	V-6, 5.9 L DIESEL	2003	-	2008
DODGE	RAM 4000	V-6, 6.7 L DIESEL	2008	-	2009
DODGE	RAM SERIES PICKUP	6 CIL, 5.9 L	2003	-	2007

**38286**



TOYOTA	CELICA	4 CIL, 1.8 L	2000	-	2005
TOYOTA	COROLLA	4 CIL, 1.8 L	2000	-	2001
TOYOTA	COROLLA	4 CIL, 1.8 L	2002	-	2008
TOYOTA	MATRIX	4 CIL, 1.8 L	2003	-	2008
TOYOTA	MR2 SPYDER	4 CIL, 1.8 L	2000	-	2005



**38299**

FORD THUNDERBIRD V-6, 3.8 L 1994 - 1994  
 FORD THUNDERBIRD V-6, 3.8 L 1995 - 1995



**38322**

HONDA ODYSSEY V-6, 3.5 L 2002 - 2004



**38308**

MAZDA MAZDA 6 V-6, 3.0 L 2005 - 2005

**38314**

VOLKSWAGEN BEETLE 5 CIL, 2.5 L 2009 - 2010  
 VOLKSWAGEN BORA 5 CIL, 2.5 L 2005 - 2009  
 VOLKSWAGEN BORA SPORTWAGEN 5 CIL, 2.5 L 2008 - 2009

**38315**

VOLKSWAGEN BEETLE 5 CIL, 2.5 L 2009 - 2010  
 VOLKSWAGEN BORA 5 CIL, 2.5 L 2005 - 2009  
 VOLKSWAGEN BORA SPORTWAGEN 5 CIL, 2.5 L 2008 - 2009



**38317**

AUDI Q7 V-6, 3.6 L 2007 - 2009  
 VOLKSWAGEN TOUAREG V-6, 3.2 L 2006 - 2006  
 VOLKSWAGEN TOUAREG V-6, 3.6 L 2007 - 2008



**38323**

CHRYSLER 300 V-6, 2.7 L 2005 - 2005  
 CHRYSLER 300 V-6, 3.5 L 2005 - 2006  
 CHRYSLER 300 V-8, 5.7 L 2005 - 2005  
 CHRYSLER 300 C V-6, 3.5 L 2005 - 2009  
 CHRYSLER 300 C V-8, 5.7 L 2005 - 2009  
 CHRYSLER 300 C V-8, 6.1 L 2005 - 2006  
 CHRYSLER PACIFICA V-6, 3.5 L 2004 - 2006  
 CHRYSLER PACIFICA V-6, 3.8 L 2007 - 2007  
 DODGE CHARGER V-6, 3.5 L 2006 - 2006  
 DODGE CHARGER V-6, 3.5 L 2007 - 2009  
 DODGE CHARGER V-8, 5.7 L 2006 - 2006  
 DODGE CHARGER V-8, 5.7 L 2007 - 2009  
 DODGE CHARGER V-8, 6.1 L 2006 - 2006  
 DODGE CHARGER V-8, 6.1 L 2007 - 2009  
 DODGE DURANGO V-8, 5.7 L 2008 - 2009  
 DODGE JOURNEY 4 CIL, 2.4 L 2009 - 2010  
 DODGE MAGNUM V-6, 2.7 L 2005 - 2005  
 DODGE MAGNUM V-6, 3.5 L 2005 - 2006  
 DODGE MAGNUM V-8, 5.7 L 2005 - 2005  
 DODGE RAM 2500 V-8, 5.7 L 2009 - 2009  
 JEEP COMMANDER V-8, 5.7 L 2006 - 2009  
 JEEP GRAND CHEROKEE V-8, 5.7 L 2005 - 2009  
 JEEP GRAND CHEROKEE V-8, 6.1 L 2006 - 2009  
 VOLKSWAGEN ROUTAN V-6, 3.8 L 2009 - 2010



**38327**

ACURA MDX V-6, 3.5 L 2001 - 2002  
 HONDA ODYSSEY V-6, 3.5 L 2001 - 2001  
 HONDA PILOT V-6, 3.5 L 2003 - 2004



**38328**

CADILLAC CTS V-8, 5.7 L 2004 - 2005  
 CADILLAC CTS V-8, 6.0 L 2006 - 2007  
 CHEVROLET CORVETTE V-8, 6.0 L 2005 - 2007  
 CHEVROLET CORVETTE V-8, 7.0 L 2006 - 2007  
 PONTIAC G8 V-8, 6.0 L 2009 - 2009



**38329**

ACURA	RL	V-6, 3.7 L	2009	-	2010
ACURA	TL	V-6, 3.2 L	2004	-	2005
ACURA	TL	V-6, 3.2 L	2006	-	2008
ACURA	TL	V-6, 3.5 L	2008	-	2008
HONDA	ACCORD	V-6, 3.0 L	2003	-	2007
HONDA	ODYSSEY	V-6, 3.5 L	2005	-	2010
HONDA	PILOT	V-6, 3.5 L	2005	-	2008
HONDA	RIDGELINE	V-6, 3.5 L	2006	-	2010

**38339**

FORD	E SERIES VAN	V-8, 4.6 L	2002	-	2010
FORD	E SERIES VAN	V-8, 5.4 L	2002	-	2010
FORD	F SERIES PICKUP	V-8, 4.6 L	2002	-	2006
FORD	F SERIES PICKUP	V-8, 5.4 L	2002	-	2002
FORD	F SERIES PICKUP	V-8, 5.4 L	2003	-	2006
FORD	F-150	V-8, 4.6 L	2008	-	2008
FORD	F-250	V-8, 4.6 L	2002	-	2007
FORD	F-350 SUPER DUTY	V-8, 5.4 L	2007	-	2010
FORD	F-450 SUPER DUTY	V-10, 6.8 L	2007	-	2010
FORD	F-550 SUPER DUTY	V-10, 6.8 L	2008	-	2010
FORD	LOBO	V-8, 4.6 L	2005	-	2008
FORD	LOBO	V-8, 5.4 L	2005	-	2008
FORD	SUPER DUTY PICKUP	V-10, 6.8 L	2002	-	2003
FORD	SUPER DUTY PICKUP	V-10, 6.8 L	2004	-	2006
FORD	SUPER DUTY PICKUP	V-8, 5.4 L	2002	-	2003
FORD	SUPER DUTY PICKUP	V-8, 5.4 L	2004	-	2006
FORD	SUPER DUTY VAN	V-10, 6.8 L	2002	-	2002
FORD	SUPER DUTY VAN	V-10, 6.8 L	2003	-	2005
FORD	SUPER DUTY VAN	V-8, 4.6 L	2003	-	2003
FORD	SUPER DUTY VAN	V-8, 4.6 L	2004	-	2004
FORD	SUPER DUTY VAN	V-8, 5.4 L	2002	-	2002
FORD	SUPER DUTY VAN	V-8, 5.4 L	2003	-	2005
LINCOLN	MARK LT	V-8, 5.4 L	2007	-	2008

FORD	FUSION	4 CIL, 2.3 L	2007	-	2009
------	--------	--------------	------	---	------



**38340**

NISSAN	ARMADA	V-8, 5.6 L	2005	-	2006
NISSAN	ARMADA	V-8, 5.6 L	2006	-	2010
NISSAN	PATHFINDER	V-8, 5.6 L	2004	-	2004
NISSAN	TITAN	V-8, 5.6 L	2004	-	2009

**38341**



SATURN	VUE	V-6, 3.5 L	2004	-	2007
--------	-----	------------	------	---	------



**38350**

DODGE	VIPER	V-10, 8.0 L	1998	-	2002
-------	-------	-------------	------	---	------



**38357**

MAZDA	MAZDA 3	4 CIL, 2.0 L	2006	-	2008
MAZDA	MAZDA 3	4 CIL, 2.3 L	2006	-	2008
MAZDA	MAZDA 5	4 CIL, 2.3 L	2006	-	2007



**38330**

FORD	E SERIES VAN	V-10, 6.8 L	1997	-	1998
FORD	E SERIES VAN	V-8, 4.6 L	1997	-	1998
FORD	E SERIES VAN	V-8, 4.6 L	1999	-	2001
FORD	E SERIES VAN	V-8, 5.4 L	1997	-	2001
FORD	F SERIES PICKUP	V-8, 4.6 L	1997	-	1997
FORD	F SERIES PICKUP	V-8, 4.6 L	1998	-	2001
FORD	F SERIES PICKUP	V-8, 5.4 L	1998	-	1998
FORD	F SERIES PICKUP	V-8, 5.4 L	1999	-	2001
FORD	F-250	V-8, 4.6 L	1998	-	2001
FORD	F-350 SUPER DUTY	V-8, 5.4 L	2002	-	2006
FORD	SUPER DUTY PICKUP	V-10, 6.8 L	1999	-	2000
FORD	SUPER DUTY PICKUP	V-10, 6.8 L	2001	-	2001
FORD	SUPER DUTY PICKUP	V-8, 5.4 L	1999	-	2001
FORD	SUPER DUTY VAN	V-10, 6.8 L	1997	-	1998
FORD	SUPER DUTY VAN	V-10, 6.8 L	1999	-	2001
FORD	SUPER DUTY VAN	V-8, 5.4 L	1997	-	1998
FORD	SUPER DUTY VAN	V-8, 5.4 L	1999	-	2001

**38332**



ACURA	MDX	V-6, 3.5 L	2003	-	2005
ACURA	MDX	V-6, 3.5 L	2006	-	2006
ACURA	MDX	V-6, 3.7 L	2007	-	2010
ACURA	RL	V-6, 3.5 L	2006	-	2008



**38376**

CHEVROLET	AVEO	4 CIL, 1.6 L	2008	-	2009
PONTIAC	G3	4 CIL, 1.6 L	2006	-	2008
SUZUKI	SWIFT	4 CIL, 1.6 L	2006	-	2008



**38397**

BUICK	ENCLAVE	V-6, 3.6 L	2010	-	2010
BUICK	LACROSSE	V-6, 3.6 L	2010	-	2010
CHEVROLET	CAPTIVA	V-6, 3.6 L	2008	-	2010
CHEVROLET	MALIBU	V-6, 3.6 L	2008	-	2010
CHEVROLET	TRVERSE	V-6, 3.6 L	2010	-	2011
GMC	ACADIA	V-6, 3.6 L	2007	-	2010
PONTIAC	G6	V-6, 3.6 L	2007	-	2008
PONTIAC	G8	V-6, 3.6 L	2009	-	2009
SAAB	9-3	V-6, 2.8 L	2006	-	2007
SUZUKI	GRAND VITARA	V-6, 3.2 L	2009	-	2010
SUZUKI	XL-7	V-6, 3.6 L	2007	-	2009



**38378**

NISSAN	FRONTIER	V-6, 4.0 L	2006	-	2008
NISSAN	PATHFINDER	V-6, 4.0 L	2005	-	2010
NISSAN	XTERRA	V-6, 4.0 L	2006	-	2007



**38382**

CHRYSLER	ASPEN	V-8, 5.7 L	2007	-	2009
DODGE	DURANGO	V-8, 5.7 L	2006	-	2007
DODGE	RAM 2500	V-8, 5.7 L	2008	-	2008
DODGE	RAM 3500	V-8, 5.7 L	2003	-	2007



**38384**

BMW	325CI	V-6, 2.5 L	2006	-	2006
BMW	325I	V-6, 2.5 L	2005	-	2005
BMW	325I	V-6, 3.0 L	2006	-	2006
BMW	325XI	V-6, 3.0 L	2006	-	2006
BMW	X3	6 CIL, 3.0 L	2005	-	2006
BMW	X5	6 CIL, 3.0 L	2005	-	2006



**38385**

FORD	MUSTANG SHELBY	V-8, 5.4 L	2009	-	2010
------	----------------	------------	------	---	------



**38404**

MINI	COOPER	4 CIL, 1.6 L	2005	-	2008
------	--------	--------------	------	---	------



**38405**

MINI	COOPER	4 CIL, 1.6 L	2005	-	2007
------	--------	--------------	------	---	------



**38406**

AUDI	A4	V-6, 3.0 L	2006	-	2006
------	----	------------	------	---	------



**38408**

FORD	ESCAPE	4 CIL, 2.3 L	2005	-	2007
MAZDA	MAZDA 3	4 CIL, 2.3 L	2006	-	2008
MAZDA	MAZDA 6	4 CIL, 2.3 L	2006	-	2007
MERCURY	MARINER	4 CIL, 2.3 L	2005	-	2007



**38409**

MAZDA	MAZDA 3	4 CIL, 2.3 L	2010	-	2010
MAZDA	MAZDA 6	4 CIL, 2.3 L	2006	-	2008

**38410**

TOYOTA	CAMRY	V-6, 3.5 L	2009	-	2011
TOYOTA	HIGHLANDER	V-6, 3.5 L	2008	-	2010
TOYOTA	RAV 4	V-6, 3.5 L	2008	-	2010
TOYOTA	SIENNA	V-6, 3.5 L	2007	-	2011

**38411**



TOYOTA	FJ CRUISER	V-6, 4.0 L	2007	-	2008
TOYOTA	TACOMA	V-6, 4.0 L	2009	-	2010

**38413**



MAZDA	MAZDA 3	4 CIL, 2.3 L	2010	-	2010
MAZDA	MAZDA 6	4 CIL, 2.3 L	2006	-	2008

**38415**

MERCEDES BE	SPRINTER	4 CIL, 2.2 L CDI	2008	-	2010
MERCEDES BE	VITO	4 CIL, 2.2 L	2008	-	2010



**38416**

FORD	MUSTANG	V-6, 4.0 L	2008	-	2010
------	---------	------------	------	---	------

**38417**

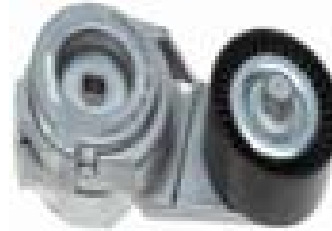

CHRYSLER	PACIFICA	V-6, 4.0 L	2007	-	2008
CHRYSLER	TOWN & COUNTRY	V-6, 4.0 L	2008	-	2010
DODGE	JOURNEY	V-6, 3.5 L	2010	-	2009

**38418**



CADILLAC	CTS	V-6, 3.6 L	2007	-	2007
----------	-----	------------	------	---	------

**38419**



CADILLAC	CTS	V-6, 3.6 L	2007	-	2007
----------	-----	------------	------	---	------

**38420**



CHEVROLET	MALIBU	V-6, 3.5 L	2007	-	2007
CHEVROLET	UPLANDER	V-6, 3.5 L	2007	-	2007
CHEVROLET	UPLANDER	V-6, 3.9 L	2007	-	2009
PONTIAC	G6	V-6, 3.5 L	2007	-	2008
PONTIAC	MONTANA	V-6, 3.9 L	2006	-	2008





**38423**

AUDI	A4	V-6, 3.2 L	2006	-	2009
AUDI	A6	V-6, 3.2 L	2006	-	2008
AUDI	Q5	V-6, 3.2 L	2009	-	2009

**38450**

AUDI	A3	V-6, 3.2 L	2007	-	2008
------	----	------------	------	---	------

**38451**

AUDI	A8	V-8, 4.2 L	2007	-	2007
------	----	------------	------	---	------

**38452**

FORD	ESCAPE	4 CIL, 2.3 L	2008	-	2008
FORD	ESCAPE	4 CIL, 2.5 L	2009	-	2010
FORD	FOCUS	4 CIL, 2.0 L	2007	-	2010
FORD	FUSION	4 CIL, 2.3 L	2007	-	2009
FORD	FUSION	4 CIL, 2.5 L	2010	-	2010
MERCURY	MILAN	4 CIL, 2.5 L	2010	-	2010

**38453**



TOYOTA	CAMRY	4 CIL, 2.4 L	2007	-	2009
TOYOTA	COROLLA	4 CIL, 2.4 L	2009	-	2010
TOYOTA	MATRIX	4 CIL, 2.4 L	2009	-	2010



**38462**

PONTIAC	G8	V-8, 6.0 L	2009	-	2009
---------	----	------------	------	---	------

**39051**

FORD	F-250 SUPER DUTY	V-8, 6.4 L DIESEL	2008	-	2010
FORD	F-450 SUPER DUTY	V-8, 6.4 L DIESEL	2008	-	2010
FORD	F-550 SUPER DUTY	V-8, 6.4 L DIESEL	2008	-	2010

**39052**

FORD	F-250 SUPER DUTY	V-8, 6.4 L DIESEL	2008	-	2010
FORD	F-450 SUPER DUTY	V-8, 6.4 L DIESEL	2008	-	2010
FORD	F-550 SUPER DUTY	V-8, 6.4 L DIESEL	2008	-	2010

**39053**

DODGE	AVENGER	4 CIL, 2.0 L	2007	-	2009
DODGE	AVENGER	4 CIL, 2.4 L	2007	-	2009
DODGE	CALIBER	4 CIL, 2.4 L	2007	-	2009
JEEP	COMPASS	4 CIL, 2.4 L	2007	-	2010
JEEP	PATRIOT	4 CIL, 2.4 L	2007	-	2010

**39070**

HONDA	CIVIC HIBRIDO	4 CIL, 1.3 L	2005	-	2010
-------	---------------	--------------	------	---	------



### 39073

CHEVROLET	CHEVY	4 CIL, 1.6 L	2009	-	2010
CHEVROLET	CHEVY C2	4 CIL, 1.6 L	2004	-	2008
CHEVROLET	CHEVY C2 SEDAN	4 CIL, 1.6 L	2004	-	2008
CHEVROLET	CHEVY JOY	4 CIL, 1.6 L	1994	-	2003
CHEVROLET	CHEVY PICK-UP	4 CIL, 1.6 L	2002	-	2006
CHEVROLET	CHEVY POP	4 CIL, 1.6 L	1994	-	2003
CHEVROLET	CHEVY SWING	4 CIL, 1.6 L	1994	-	2003
CHEVROLET	MONZA	4 CIL, 1.6 L	1994	-	2004

### T36109



ACURA	TSX	4 CIL, 2.4 L	2009	-	2009
HONDA	ACCORD	4 CIL, 2.4 L	2008	-	2010

### 39077

PEUGEOT	307	4 CIL, 2.0 L	2005	-	2008
---------	-----	--------------	------	---	------

### T36124



HONDA	CIVIC	4 CIL, 1.8 L	2008	-	2010
-------	-------	--------------	------	---	------

### 39083

FORD	TRANSIT	4 CIL, 2.2 L	2008	-	2010
------	---------	--------------	------	---	------

### T38313



CADILLAC	ESCALADE	V-8, 6.2 L	2009	-	2010
CHEVROLET	AVALANCHE	V-8, 5.3 L	2009	-	2010
CHEVROLET	EXPRESS	V-8, 5.3 L	2009	-	2010
CHEVROLET	EXPRESS	V-8, 6.0 L	2009	-	2010
CHEVROLET	SILVERADO	V-8, 4.8 L	2009	-	2010
CHEVROLET	SILVERADO	V-8, 5.3 L	2009	-	2010
CHEVROLET	SUBURBAN	V-8, 5.3 L	2009	-	2010
CHEVROLET	SUBURBAN	V-8, 6.0 L	2009	-	2010
CHEVROLET	TAHOE	V-8, 5.3 L	2009	-	2010
GMC	SIERRA	V-8, 5.3 L	2009	-	2010
GMC	SIERRA	V-8, 6.2 L	2009	-	2010
GMC	YUKON	V-8, 6.2 L	2009	-	2010
HUMMER	H2	V-8, 6.2 L	2009	-	2010

### 39092

PEUGEOT	207	4 CIL, 1.6 L	2008	-	2009
---------	-----	--------------	------	---	------

### T38320



HONDA	ACCORD	V-6, 3.5 L	2008	-	2010
HONDA	ODYSSEY	V-6, 3.5 L	2008	-	2010
HONDA	PILOT	V-6, 3.5 L	2009	-	2010

### T36038



PEUGEOT	307	4 CIL, 2.0 L	2005	-	2008
---------	-----	--------------	------	---	------

### T38368



FIAT	BRAVO	4 CIL, 1.4 L	2009	-	2010
FIAT	GRANDE PUNTO	4 CIL, 1.4 L	2009	-	2010

CHEVROLET	C y K SERIES PICKUP C-30	4 CIL, 1.6 L	2003	-	2003
CHEVROLET	CHEVY	4 CIL, 1.6 L	1997	-	2007



### T38415



MERCEDES BE	SPRINTER	4 CIL, 2.2 L	2006	-	2007
MERCEDES BE	SPRINTER	4 CIL, 2.2 L CDI	2006	-	2007
MERCEDES BE	SPRINTER	5 CIL, 2.7 L	2006	-	2007
MERCEDES BE	SPRINTER	5 CIL, 2.7 L CDI	2003	-	2005
MERCEDES BE	SPRINTER	5 CIL, 2.7 L CDI	2006	-	2006

### T38428



RENAULT	MEGANE	4 CIL, 2.0 L	2004	-	2009
RENAULT	SCENIC	4 CIL, 2.0 L	2004	-	2009

### T38433



CHEVROLET	CRUZE	4 CIL, 1.8 L	2010	-	2011
-----------	-------	--------------	------	---	------

### T38456

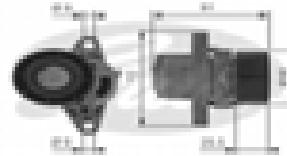

NISSAN	APRIO	4 CIL, 1.6 L	2008	-	2010
NISSAN	PLATINA	4 CIL, 1.6 L	2002	-	2010
RENAULT	CLIO	4 CIL, 1.6 L	2003	-	2009
RENAULT	KANGOO	4 CIL, 1.6 L	2003	-	2010
RENAULT	KANGOO EXPRESS	4 CIL, 1.6 L	2005	-	2009

### T38484



NISSAN	APRIO	4 CIL, 1.6 L	2008	-	2010
NISSAN	PLATINA	4 CIL, 1.6 L	2002	-	2010
RENAULT	CLIO	4 CIL, 1.6 L	2003	-	2009
RENAULT	KANGOO	4 CIL, 1.6 L	2003	-	2010
RENAULT	KANGOO EXPRESS	4 CIL, 1.6 L	2005	-	2009

### T39074

MAZDA	CX-7	4 CIL, 2.3 L	2006	-	2008
-------	------	--------------	------	---	------

### T41001



CHRYSLER	DAYTONA	4 CIL, 2.2 L	1990	-	1992
CHRYSLER	DAYTONA	4 CIL, 2.5 L	1990	-	1993
CHRYSLER	LEBARON	4 CIL, 2.2 L	1990	-	1990
CHRYSLER	LEBARON	4 CIL, 2.5 L	1990	-	1992
CHRYSLER	LEBARON	4 CIL, 2.5 L	1993	-	1994
DODGE	CARAVAN	4 CIL, 2.5 L	1995	-	1995
DODGE	DAKOTA	4 CIL, 2.5 L	1995	-	1995
DODGE	SHADOW	4 CIL, 2.2 L	1994	-	1994
DODGE	SHADOW	4 CIL, 2.5 L	1994	-	1994
DODGE	SPIRIT	4 CIL, 2.5 L	1994	-	1994
DODGE	SPIRIT	4 CIL, 2.5 L	1995	-	1995

### T41002



CHRYSLER	CIRRUS	4 CIL, 2.0 L	2000	-	2000
CHRYSLER	CONCORDE	V-6, 3.5 L	1995	-	1997
CHRYSLER	INTREPID	V-6, 3.5 L	1995	-	1997
CHRYSLER	LHS	V-6, 3.5 L	1995	-	1997
CHRYSLER	NEON	4 CIL, 2.0 L	2000	-	2002
CHRYSLER	NEW YORKER	V-6, 3.5 L	1995	-	1996
CHRYSLER	SEBRING	4 CIL, 2.0 L	1995	-	1999
DODGE	INTREPID	V-6, 3.5 L	1995	-	1997
DODGE	NEON	4 CIL, 2.0 L	1995	-	2002
DODGE	STRATUS	4 CIL, 2.0 L	1995	-	2000

### T41005



FORD	RANGER	4 CIL, 2.3 L	1994	-	1994
FORD	RANGER	4 CIL, 2.3 L	1995	-	2001
FORD	RANGER	4 CIL, 2.5 L	1998	-	2001



**T41007**

FORD ESCORT 4 CIL, 1.9 L 1994 - 1996



**T41015**

HONDA ACCORD V-6, 2.7 L 1995 - 1997



**T41008**

FORD CONTOUR 4 CIL, 2.0 L 1995 - 1997  
 FORD CONTOUR 4 CIL, 2.0 L 1996 - 1996  
 MERCURY MYSTIQUE 4 CIL, 2.0 L 1995 - 1997



**T41016**

ACURA INTEGRA 4 CIL, 1.8 L 1999 - 2001  
 HONDA CIVIC 4 CIL, 1.6 L 1999 - 2000  
 HONDA CIVIC DEL SOL 4 CIL, 1.6 L 1995 - 1997  
 HONDA CR-V 4 CIL, 2.0 L 1997 - 1998  
 HONDA CR-V 4 CIL, 2.0 L 1999 - 2001



**T41011**

HONDA CIVIC 4 CIL, 1.5 L 1995 - 1995  
 HONDA CIVIC DEL SOL 4 CIL, 1.5 L 1995 - 1995



**T41020**

HONDA CIVIC 4 CIL, 1.5 L 1995 - 1995  
 HONDA CIVIC DEL SOL 4 CIL, 1.5 L 1995 - 1995



**T41013**

ACURA CL 4 CIL, 2.3 L 1998 - 1999  
 HONDA ACCORD 4 CIL, 2.2 L 1995 - 1997  
 HONDA ACCORD 4 CIL, 2.3 L 1998 - 2002  
 HONDA ODYSSEY 4 CIL, 2.2 L 1995 - 1997  
 HONDA ODYSSEY 4 CIL, 2.3 L 1998 - 1998

ACURA TL 5 CIL, 2.5 L 1998 - 1998

**T41021**



ACURA CL 4 CIL, 2.3 L 1998 - 1999  
 HONDA ACCORD 4 CIL, 2.2 L 1995 - 1997  
 HONDA ACCORD 4 CIL, 2.3 L 1998 - 2002  
 HONDA ODYSSEY 4 CIL, 2.2 L 1995 - 1997  
 HONDA ODYSSEY 4 CIL, 2.3 L 1998 - 1998

**T41014**



ACURA TL V-6, 3.2 L 1998 - 1998

**T41022**



ACURA CL 4 CIL, 2.3 L 1998 - 1999  
 HONDA ACCORD 4 CIL, 2.2 L 1995 - 1997  
 HONDA ACCORD 4 CIL, 2.3 L 1998 - 2002  
 HONDA ODYSSEY 4 CIL, 2.2 L 1995 - 1997  
 HONDA ODYSSEY 4 CIL, 2.3 L 1998 - 1998

HONDA PRELUDE 4 CIL, 2.2 L 2001 - 2001

**T41023**

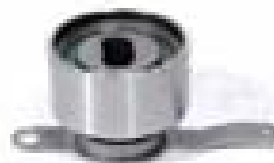

HONDA CIVIC 4 CIL, 1.6 L 1995 - 1996



HONDA	CIVIC	4 CIL, 1.6 L	1997 - 2000
HONDA	CIVIC DEL SOL	4 CIL, 1.6 L	1995 - 1997

**T41024**



HONDA	PRELUDE	4 CIL, 2.2 L	2001 - 2001
-------	---------	--------------	-------------

**T41028**



ACURA	SLX	V-6, 3.5 L	1999 - 1999
HONDA	PASSPORT	V-6, 3.2 L	1997 - 2002

**T41031**



FORD	ESCORT	4 CIL, 1.8 L	1994 - 1996
MAZDA	MX-5 MIATA	4 CIL, 1.8 L	2005 - 2005

**T41037**



HYUNDAI	ACCENT	4 CIL, 1.5 L	2000 - 2003
HYUNDAI	ACCENT	4 CIL, 1.6 L	2001 - 2006
HYUNDAI	ATTITUDE	4 CIL, 1.6 L	2006 - 2007
HYUNDAI	ATTITUDE	4 CIL, 1.4 L	2008 - 2010
HYUNDAI	ATTITUDE	4 CIL, 1.6 L	2008 - 2010
HYUNDAI	ATTITUDE	4 CIL, 1.6 L	2006 - 2007
HYUNDAI	VERNA	4 CIL, 1.5 L	2004 - 2006
HYUNDAI	VERNA	4 CIL, 1.5 L	2007 - 2007
HYUNDAI	VERNA	4 CIL, 1.6 L	2005 - 2006

**T41038**



CHRYSLER	SEBRING	4 CIL, 2.4 L	2001 - 2004
DODGE	STRATUS	4 CIL, 2.4 L	2001 - 2004
CHRYSLER	ECLIPSE	4 CIL, 2.4 L	2000 - 2005
CHRYSLER	GALANT	4 CIL, 2.4 L	2000 - 2003
CHRYSLER	GALANT	4 CIL, 2.4 L	2004 - 2007

MITSUBISHI	LANCER	4 CIL, 2.0 L	2003 - 2003
MITSUBISHI	LANCER	4 CIL, 2.0 L	2004 - 2006
MITSUBISHI	LANCER	4 CIL, 2.4 L	2004 - 2005
MITSUBISHI	OUTLANDER	4 CIL, 2.4 L	2003 - 2003
MITSUBISHI	OUTLANDER	4 CIL, 2.4 L	2004 - 2006

**T41039**



CHRYSLER	CIRRUS	V-6, 2.5 L	1995 - 2000
CHRYSLER	SEBRING	V-6, 2.5 L	1995 - 1995
CHRYSLER	SEBRING	V-6, 2.5 L	1996 - 2000
CHRYSLER	SEBRING	V-6, 3.0 L	2001 - 2005
DODGE	STRATUS	V-6, 2.5 L	1995 - 2000
DODGE	STRATUS	V-6, 3.0 L	2001 - 2003
DODGE	STRATUS	V-6, 3.0 L	2004 - 2004
MITSUBISHI	DIAMANTE	V-6, 3.5 L	2000 - 2004
MITSUBISHI	ECLIPSE	V-6, 3.0 L	2000 - 2003
MITSUBISHI	ECLIPSE	V-6, 3.0 L	2004 - 2005
MITSUBISHI	ECLIPSE	V-6, 3.8 L	2007 - 2008
MITSUBISHI	ENDEAVOR	V-6, 3.8 L	2004 - 2007
MITSUBISHI	GALANT	V-6, 3.0 L	2000 - 2003
MITSUBISHI	GALANT	V-6, 3.8 L	2004 - 2005
MITSUBISHI	MONTERO	V-6, 3.5 L	2000 - 2002
MITSUBISHI	MONTERO	V-6, 3.8 L	2003 - 2003
MITSUBISHI	MONTERO	V-6, 3.8 L	2004 - 2007
MITSUBISHI	MONTERO SPORT	V-6, 3.0 L	2000 - 2003
MITSUBISHI	MONTERO SPORT	V-6, 3.5 L	2000 - 2003
MITSUBISHI	MONTERO SPORT	V-6, 3.5 L	2004 - 2004

**T41044**



HYUNDAI	H100	4 CIL, 2.4 L	2003 - 2005
---------	------	--------------	-------------

**T41048**



CHRYSLER	DAYTONA	V-6, 3.0 L	1990 - 1993
CHRYSLER	GRAND VOYAGER	V-6, 3.0 L	2000 - 2000
CHRYSLER	LEBARON	V-6, 3.0 L	1990 - 1992
CHRYSLER	LEBARON	V-6, 3.0 L	1993 - 1995
CHRYSLER	TOWN & COUNTRY VAN	V-6, 3.0 L	1990 - 1990
CHRYSLER	VOYAGER	V-6, 3.0 L	2000 - 2000
DODGE	CARAVAN	V-6, 3.0 L	1995 - 1995
DODGE	CARAVAN	V-6, 3.0 L	1996 - 2000
DODGE	GRAND CARAVAN	V-6, 3.0 L	1995 - 2000
DODGE	SPIRIT	V-6, 3.0 L	1994 - 1994
DODGE	SPIRIT	V-6, 3.0 L	1995 - 1995



### T41054

CHEVROLET	TRACKER	4 CIL, 1.6 L	1998	-	2000
CHEVROLET	TRACKER	4 CIL, 1.6 L	2001	-	2002

CHRYSLER	SEBRING	4 CIL, 2.4 L	2001	-	2004
DODGE	STRATUS	4 CIL, 2.4 L	2001	-	2004
MITSUBISHI	ECLIPSE	4 CIL, 2.4 L	2000	-	2005
MITSUBISHI	GALANT	4 CIL, 2.4 L	2000	-	2003
MITSUBISHI	OUTLANDER	4 CIL, 2.4 L	2003	-	2003

### T41058

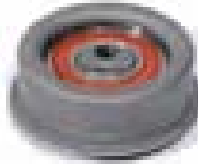

NISSAN	TSURU	4 CIL, 1.6 L	1981	-	1988
--------	-------	--------------	------	---	------

### T41059



NISSAN	FRONTIER	V-6, 3.3 L	1999	-	2004
NISSAN	MAXIMA	V-6, 3.0 L	1990	-	1992
NISSAN	MAXIMA	V-6, 3.0 L	1993	-	1994
NISSAN	PATHFINDER	V-6, 3.0 L	1990	-	1994
NISSAN	PATHFINDER	V-6, 3.0 L	1995	-	1995
NISSAN	PATHFINDER	V-6, 3.3 L	1996	-	1996
NISSAN	PATHFINDER	V-6, 3.3 L	1997	-	2000
NISSAN	PICK-UP	V-6, 3.0 L	1990	-	1995
NISSAN	QUEST	V-6, 3.0 L	1993	-	1996
NISSAN	QUEST	V-6, 3.0 L	1997	-	1998
NISSAN	QUEST	V-6, 3.3 L	1999	-	2001
NISSAN	QUEST	V-6, 3.3 L	2002	-	2002
NISSAN	XTERRA	V-6, 3.3 L	2000	-	2002
NISSAN	XTERRA	V-6, 3.3 L	2003	-	2004

### T41064

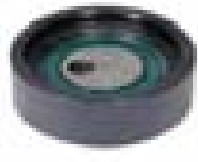

CHEVROLET	TRACKER	4 CIL, 1.6 L	1989	-	1992
-----------	---------	--------------	------	---	------

### T41065



### T41067

TOYOTA	CAMRY	4 CIL, 2.2 L	2000	-	2000
TOYOTA	CAMRY	4 CIL, 2.2 L	2001	-	2001
TOYOTA	CAMRY SOLARA	4 CIL, 2.2 L	2000	-	2000
TOYOTA	RAV 4	4 CIL, 2.0 L	2000	-	2000
TOYOTA	SOLARA	4 CIL, 2.2 L	2001	-	2001

### T41075



TOYOTA	AVALON	V-6, 3.0 L	2000	-	2004
TOYOTA	CAMRY	V-6, 3.0 L	2000	-	2000
TOYOTA	CAMRY	V-6, 3.0 L	2001	-	2001
TOYOTA	CAMRY SOLARA	V-6, 3.0 L	2000	-	2000
TOYOTA	SIENNA	V-6, 3.0 L	2000	-	2003
TOYOTA	SOLARA	V-6, 3.0 L	2001	-	2003

### T41078



TOYOTA	4 RUNNER	V-8, 4.7 L	2003	-	2007
TOYOTA	LAND CRUISER	V-8, 4.7 L	2000	-	2002
TOYOTA	LAND CRUISER	V-8, 4.7 L	2003	-	2006
TOYOTA	SEQUOIA	V-8, 4.7 L	2001	-	2006
TOYOTA	SEQUOIA	V-8, 4.7 L	2007	-	2008
TOYOTA	TUNDRA	V-8, 4.7 L	2000	-	2006
TOYOTA	TUNDRA	V-8, 4.7 L	2007	-	2008

### T41079



VOLKSWAGEN	CABRIO	4 CIL, 2.0 L	1995	-	2002
VOLKSWAGEN	DERBY	4 CIL, 1.8 L	2005	-	2008
VOLKSWAGEN	GOLF	4 CIL, 2.0 L	1995	-	2000
VOLKSWAGEN	JETTA	4 CIL, 2.0 L	1995	-	2000
VOLKSWAGEN	PASSAT	4 CIL, 2.0 L	1995	-	1996
VOLKSWAGEN	POINTER	4 CIL, 1.8 L	1998	-	2008



### T41084

CHRYSLER	300M	V-6, 3.5 L	1999	-	2002
CHRYSLER	CONCORDE	V-6, 3.2 L	1998	-	2000
CHRYSLER	CONCORDE	V-6, 3.5 L	1993	-	2002
CHRYSLER	INTREPID	V-6, 3.2 L	1998	-	2000
CHRYSLER	INTREPID	V-6, 3.5 L	1993	-	2002
CHRYSLER	LHS	V-6, 3.5 L	1994	-	2001
CHRYSLER	NEW YORKER	V-6, 3.5 L	1994	-	1994
DODGE	INTREPID	V-6, 3.2 L	1998	-	2000
DODGE	INTREPID	V-6, 3.5 L	2000	-	2002



### T41204

TOYOTA	4 RUNNER	V-6, 3.4 L	2000	-	2001
TOYOTA	4 RUNNER	V-6, 3.4 L	2002	-	2002
TOYOTA	TACOMA	V-6, 3.4 L	2000	-	2004
TOYOTA	TUNDRA	V-6, 3.4 L	2000	-	2004



### T41085

NISSAN	300ZX	V-6, 3.0 L	1990	-	1992
NISSAN	300ZX	V-6, 3.0 L	1993	-	1996



### T41212

MITSUBISHI	LANCER	4 CIL, 2.0 L	2002	-	2003
MITSUBISHI	LANCER	4 CIL, 2.0 L	2004	-	2008
MITSUBISHI	MIRAGE	4 CIL, 1.8 L	2000	-	2002

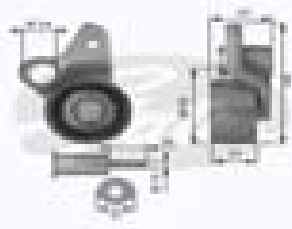

### T41086

AUDI	A4	V-6, 3.0 L	2006	-	2006
------	----	------------	------	---	------



### T41228

VOLKSWAGEN	TOUAREG	V-8, 4.2 L	2006	-	2006
------------	---------	------------	------	---	------

### T41229



### T41090

ACURA	TL	V-6, 3.2 L	1999	-	2000
HONDA	ACCORD	V-6, 3.0 L	1998	-	2001

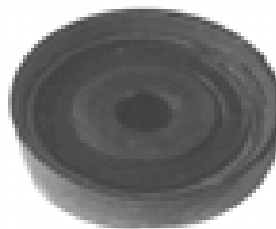

VOLKSWAGEN	BORA	4 CIL, 1.9 L DIESE	2007	-	2007
VOLKSWAGEN	BORA	4 CIL, 2.0 L DIESE	2009	-	2010
VOLKSWAGEN	EUROVAN	4 CIL, 1.9 L	2007	-	2008
VOLKSWAGEN	EUROVAN	4 CIL, 1.9 L DIESE	2005	-	2009
VOLKSWAGEN	JETTA	4 CIL, 1.9 L DIESE	2005	-	2007

### T41230



### T41098

VOLKSWAGEN	TOUAREG	V-8, 4.2 L	2006	-	2006
------------	---------	------------	------	---	------



VOLKSWAGEN	TOUAREG	V-8, 4.2 L	2006	-	2006
------------	---------	------------	------	---	------



### T41231

RENAULT STEPWAY

4 CIL, 1.6 L 2010 - 2010



### T41240

ACURA	MDX	V-6, 3.5 L	2006	-	2006
ACURA	MDX	V-6, 3.7 L	2007	-	2010
ACURA	RL	V-6, 3.5 L	2006	-	2008
ACURA	RL	V-6, 3.7 L	2009	-	2010
ACURA	TL	V-6, 3.2 L	2006	-	2008
ACURA	TL	V-6, 3.5 L	2008	-	2010
ACURA	TL	V-6, 3.7 L	2009	-	2010
ACURA	TSX	V-6, 3.5 L	2010	-	2010
HONDA	ACCORD	V-6, 3.5 L	2008	-	2010
HONDA	ODYSSEY	V-6, 3.5 L	2008	-	2010
HONDA	PILOT	V-6, 3.5 L	2008	-	2010
HONDA	RIDGELINE	V-6, 3.5 L	2008	-	2010

RENAULT TRAFIC

4 CIL, 1.9 L DIESEL 2008 - 2010



### T41241



### T41232

ACURA	MDX	V-6, 3.5 L	2006	-	2006
ACURA	MDX	V-6, 3.7 L	2007	-	2010
ACURA	RL	V-6, 3.5 L	2006	-	2008
ACURA	RL	V-6, 3.7 L	2009	-	2010
ACURA	TL	V-6, 3.2 L	2006	-	2008
ACURA	TL	V-6, 3.5 L	2008	-	2010
ACURA	TL	V-6, 3.7 L	2009	-	2010
ACURA	TSX	V-6, 3.5 L	2010	-	2010
HONDA	ACCORD	V-6, 3.0 L	2005	-	2007
HONDA	ACCORD	V-6, 3.5 L	2008	-	2010
HONDA	ODYSSEY	V-6, 3.5 L	2006	-	2010
HONDA	PILOT	V-6, 3.5 L	2006	-	2010
HONDA	RIDGELINE	V-6, 3.5 L	2006	-	2010

HYUNDAI ATOS  
HYUNDAI ATOS  
HYUNDAI ATOS

4 CIL, 1.0 L 2000 - 2004  
4 CIL, 1.1 L 2005 - 2008  
4 CIL, 1.1 L 2008 - 2010



### T41267

PONTIAC MATIZ G2

4 CIL, 1.0 L 2003 - 2009



### T42002



### T41235

ACURA	MDX	V-6, 3.5 L	2006	-	2006
ACURA	MDX	V-6, 3.7 L	2007	-	2010
ACURA	RL	V-6, 3.5 L	2006	-	2008
ACURA	RL	V-6, 3.7 L	2009	-	2010
ACURA	TL	V-6, 3.2 L	2006	-	2008
ACURA	TL	V-6, 3.5 L	2008	-	2010
ACURA	TL	V-6, 3.7 L	2009	-	2010
ACURA	TSX	V-6, 3.5 L	2010	-	2010
HONDA	ACCORD	V-6, 3.0 L	2005	-	2007
HONDA	ACCORD	V-6, 3.5 L	2008	-	2010
HONDA	ODYSSEY	V-6, 3.5 L	2006	-	2010
HONDA	PILOT	V-6, 3.5 L	2006	-	2010
HONDA	RIDGELINE	V-6, 3.5 L	2006	-	2010

HONDA PASSPORT

V-6, 3.2 L 1997 - 1997



### T42005

PEUGEOT 307 4 CIL, 2.0 L 2005 - 2008

### T41237



FORD ESCORT  
MAZDA MX-5 MIATA

4 CIL, 1.8 L 1994 - 1996  
4 CIL, 1.8 L 2005 - 2005



### T42016

NISSAN	APRIO	4 CIL, 1.6 L	2008	-	2010
NISSAN	PLATINA	4 CIL, 1.6 L	2002	-	2010
RENAULT	CLIO	4 CIL, 1.6 L	2003	-	2009
RENAULT	EUROCLIO	4 CIL, 1.6 L	2007	-	2008
RENAULT	KANGOO	4 CIL, 1.6 L	2003	-	2010
RENAULT	KANGOO EXPRESS	4 CIL, 1.6 L	2005	-	2009
RENAULT	SANDERO	4 CIL, 1.6 L	2010	-	2010

HYUNDAI ACCENT

4 CIL, 1.6 L 2001 - 2006





HYUNDAI	ATTITUDE	4 CIL, 1,4 L	2008	-	2010
HYUNDAI	ATTITUDE	4 CIL, 1,6 L	2008	-	2010
HYUNDAI	ATTITUDE	4 CIL, 1,6 L	2006	-	2007

### T42017



CHRYSLER	SEBRING	4 CIL, 2,4 L	2001	-	2004
DODGE	STRATUS	4 CIL, 2,4 L	2001	-	2004
MITSUBISHI	ECLIPSE	4 CIL, 2,4 L	2000	-	2005
MITSUBISHI	GALANT	4 CIL, 2,4 L	2000	-	2003
MITSUBISHI	LANCER	4 CIL, 2,0 L	2003	-	2003
MITSUBISHI	LANCER	4 CIL, 2,0 L	2004	-	2005
MITSUBISHI	OUTLANDER	4 CIL, 2,4 L	2003	-	2003

### T42018



CHRYSLER	CIRRUS	V-6, 2,5 L	1995	-	2000
CHRYSLER	SEBRING	V-6, 2,5 L	1995	-	1995
CHRYSLER	SEBRING	V-6, 2,5 L	1996	-	2000
CHRYSLER	SEBRING	V-6, 3,0 L	2001	-	2005
DODGE	STRATUS	V-6, 2,5 L	1995	-	2000
DODGE	STRATUS	V-6, 3,0 L	2001	-	2003
DODGE	STRATUS	V-6, 3,0 L	2004	-	2004
MITSUBISHI	DIAMANTE	V-6, 3,5 L	2000	-	2004
MITSUBISHI	ECLIPSE	V-6, 3,0 L	2000	-	2003
MITSUBISHI	ECLIPSE	V-6, 3,0 L	2004	-	2005
MITSUBISHI	ECLIPSE	V-6, 3,8 L	2007	-	2008
MITSUBISHI	ENDEAVOR	V-6, 3,8 L	2004	-	2007
MITSUBISHI	GALANT	V-6, 3,0 L	2000	-	2003
MITSUBISHI	GALANT	V-6, 3,8 L	2004	-	2005
MITSUBISHI	MONTERO	V-6, 3,5 L	2000	-	2002
MITSUBISHI	MONTERO	V-6, 3,8 L	2003	-	2003
MITSUBISHI	MONTERO	V-6, 3,8 L	2004	-	2007
MITSUBISHI	MONTERO SPORT	V-6, 3,0 L	2000	-	2003
MITSUBISHI	MONTERO SPORT	V-6, 3,5 L	2000	-	2003
MITSUBISHI	MONTERO SPORT	V-6, 3,5 L	2004	-	2004

### T42019



AUDI	A3	4 CIL, 2,0 L	2006	-	2008
AUDI	A4	4 CIL, 1,8 L	2006	-	2006
SEAT	ALTEA	4 CIL, 2,0 L	2006	-	2008
SEAT	LEON	4 CIL, 2,0 L	2006	-	2007
SEAT	TOLEDO	4 CIL, 2,0 L	2006	-	2007
VOLKSWAGEN	GLI	4 CIL, 2,0 L TURB	2007	-	2008
VOLKSWAGEN	GTI	4 CIL, 2,0 L TURB	2007	-	2008

### T42020



NISSAN	300ZX	V-6, 3,0 L	1990	-	1992
NISSAN	300ZX	V-6, 3,0 L	1993	-	1996

### T42021



NISSAN	300ZX	V-6, 3,0 L	1990	-	1992
NISSAN	300ZX	V-6, 3,0 L	1993	-	1996

### T42023



SUBARU	FORESTER	4 CIL, 2,5 L	2004	-	2004
SUBARU	FORESTER	4 CIL, 2,5 L	2006	-	2006
SUBARU	IMPREZA	4 CIL, 2,0 L	2004	-	2004
SUBARU	IMPREZA	4 CIL, 2,5 L	2004	-	2004
SUBARU	IMPREZA	4 CIL, 2,5 L	2006	-	2006
SUBARU	LEGACY	4 CIL, 2,5 L	2006	-	2006
SUBARU	OUTBACK	4 CIL, 2,5 L	2005	-	2005
SUBARU	OUTBACK	4 CIL, 2,5 L	2006	-	2006

### T42024



SUBARU	FORESTER	4 CIL, 2,5 L	2004	-	2004
SUBARU	FORESTER	4 CIL, 2,5 L	2006	-	2006
SUBARU	IMPREZA	4 CIL, 2,0 L	2004	-	2004
SUBARU	IMPREZA	4 CIL, 2,5 L	2004	-	2004
SUBARU	IMPREZA	4 CIL, 2,5 L	2006	-	2006
SUBARU	LEGACY	4 CIL, 2,5 L	2006	-	2006
SUBARU	OUTBACK	4 CIL, 2,5 L	2005	-	2005
SUBARU	OUTBACK	4 CIL, 2,5 L	2006	-	2006

### T42025



TOYOTA	CAMRY	4 CIL, 2,2 L	2000	-	2000
--------	-------	--------------	------	---	------



TOYOTA	CAMRY	4 CIL, 2.2 L	2001	-	2001
TOYOTA	CAMRY SOLARA	4 CIL, 2.2 L	2000	-	2000
TOYOTA	RAV 4	4 CIL, 2.0 L	2000	-	2000
TOYOTA	SOLARA	4 CIL, 2.2 L	2001	-	2001



**T42030**

TOYOTA	AVALON	V-6, 3.0 L	2000	-	2004
TOYOTA	CAMRY	V-6, 3.0 L	2000	-	2000
TOYOTA	CAMRY	V-6, 3.0 L	2001	-	2006
TOYOTA	CAMRY	V-6, 3.3 L	2004	-	2006
TOYOTA	CAMRY SOLARA	V-6, 3.0 L	2000	-	2000
TOYOTA	HIGHLANDER	V-6, 3.0 L	2001	-	2003
TOYOTA	HIGHLANDER	V-6, 3.3 L	2004	-	2007
TOYOTA	SIENNA	V-6, 3.0 L	2000	-	2003
TOYOTA	SIENNA	V-6, 3.3 L	2004	-	2006
TOYOTA	SOLARA	V-6, 3.0 L	2001	-	2003
TOYOTA	SOLARA	V-6, 3.3 L	2004	-	2007
TOYOTA	SOLARA	V-6, 3.3 L	2005	-	2006



**T42031**

TOYOTA	4 RUNNER	V-8, 4.7 L	2003	-	2007
TOYOTA	LAND CRUISER	V-8, 4.7 L	2000	-	2002
TOYOTA	LAND CRUISER	V-8, 4.7 L	2003	-	2006
TOYOTA	SEQUOIA	V-8, 4.7 L	2001	-	2006
TOYOTA	SEQUOIA	V-8, 4.7 L	2007	-	2008
TOYOTA	TUNDRA	V-8, 4.7 L	2000	-	2006
TOYOTA	TUNDRA	V-8, 4.7 L	2007	-	2008



**T42032**

FORD	CONTOUR	4 CIL, 2.0 L	1995	-	1997
FORD	CONTOUR	4 CIL, 2.0 L	1996	-	1996
MERCURY	MYSTIQUE	4 CIL, 2.0 L	1995	-	1997



**T42033**

FORD	CONTOUR	4 CIL, 2.0 L	1995	-	1997
FORD	CONTOUR	4 CIL, 2.0 L	1996	-	1996
MERCURY	MYSTIQUE	4 CIL, 2.0 L	1995	-	1997



**T42034**

FORD	CONTOUR	4 CIL, 2.0 L	1998	-	2000
FORD	ESCAPE	4 CIL, 2.0 L	2001	-	2002
FORD	ESCAPE	4 CIL, 2.0 L	2003	-	2004
FORD	ESCORT	4 CIL, 2.0 L	1998	-	2002
FORD	FOCUS	4 CIL, 2.0 L	2000	-	2004
FORD	ZX2	4 CIL, 2.0 L	2003	-	2003
MERCURY	MYSTIQUE	4 CIL, 2.0 L	1998	-	2000



**T42035**

FORD	CONTOUR	4 CIL, 2.0 L	1998	-	1999
FORD	ESCORT	4 CIL, 2.0 L	1998	-	1999
MERCURY	MYSTIQUE	4 CIL, 2.0 L	1998	-	1999



**T42036**

FORD	CONTOUR	4 CIL, 2.0 L	1999	-	2000
FORD	ESCAPE	4 CIL, 2.0 L	2001	-	2002
FORD	ESCAPE	4 CIL, 2.0 L	2003	-	2004
FORD	ESCORT	4 CIL, 2.0 L	1999	-	2002
FORD	FOCUS	4 CIL, 2.0 L	2000	-	2004
FORD	ZX2	4 CIL, 2.0 L	2003	-	2003
MERCURY	MYSTIQUE	4 CIL, 2.0 L	1999	-	2000



**T42038**

ACURA	TL	V-6, 3.2 L	1999	-	2000
HONDA	ACCORD	V-6, 3.0 L	1998	-	2001

**T42044**

VOLKSWAGEN	TOUAREG	V-6, 3.0 L DIESEL	2009	-	2010
------------	---------	-------------------	------	---	------

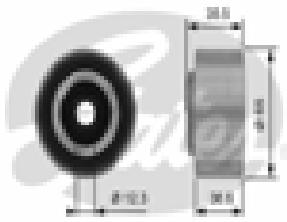

**T42061**

JEEP	LIBERTY	4 CIL, 2.4 L	2002	-	2005
JEEP	WRANGLER	4 CIL, 2.4 L	2003	-	2006

**T42129**

FIAT	PALIO	4 CIL, 1.6 L	2003	-	2006
FIAT	PALIO ADVENTURE	4 CIL, 1.6 L	2003	-	2006

**T42066**

HYUNDAI	H100	4 CIL, 2.5 L DIESE	2009	-	2010
HYUNDAI	H100 VAN/WAGON	4 CIL, 2.5 L DIESE	2009	-	2010

**T42137**



PEUGEOT	GRAND RAID	4 CIL, 1.6 L	2004	-	2008
PEUGEOT	PARTNER	4 CIL, 1.6 L	2006	-	2008

**T42097**

AUDI	A4	V-6, 3.0 L	2006	-	2006
------	----	------------	------	---	------

**T42138**



VOLVO	C30	5 CIL, 2.4 L	2008	-	2010
VOLVO	C30	5 CIL, 2.5 L	2008	-	2010
VOLVO	S40	5 CIL, 2.4 L	2005	-	2008
VOLVO	S40	5 CIL, 2.5 L	2007	-	2008
VOLVO	XC90	5 CIL, 2.5 L	2003	-	2006

**T42115**

AUDI	A4	V-6, 3.0 L	2006	-	2006
------	----	------------	------	---	------

**T42163**



ACURA	SLX	V-6, 3.5 L	1999	-	1999
HONDA	PASSPORT	V-6, 3.2 L	1998	-	2002

**T42121**

FIAT	DUCATO	4 CIL, 2.3 L DIESE	2008	-	2010
------	--------	--------------------	------	---	------

**T42166**



CHRYSLER	CIRRUS	4 CIL, 2.4 L	1995	-	2000
CHRYSLER	PT CRUISER	4 CIL, 2.4 L	2001	-	2010
CHRYSLER	SEBRING	4 CIL, 2.4 L	1996	-	2005
CHRYSLER	VOYAGER	4 CIL, 2.4 L	2000	-	2003
DODGE	CARAVAN	4 CIL, 2.4 L	1996	-	2006
DODGE	CARAVAN	4 CIL, 2.4 L	1997	-	2002
DODGE	GRAND CARAVAN	4 CIL, 2.4 L	1996	-	1997
DODGE	NEON	4 CIL, 2.4 L	2003	-	2005
DODGE	STRATUS	4 CIL, 2.4 L	1995	-	2006
DODGE	STRATUS	4 CIL, 2.4 L	2005	-	2005

RENAULT	CLIO	4 CIL, 2.0 L SPOR	2003	-	2006
RENAULT	MEGANE	4 CIL, 2.0 L	2009	-	2009
RENAULT	MEGANE	4 CIL, 2.0 L	2001	-	2008
RENAULT	SCENIC	4 CIL, 2.0 L	2009	-	2009
RENAULT	SCENIC	4 CIL, 2.0 L	2001	-	2007



### T42167



RENAULT	MEGANE	4 CIL, 2.0 L	2004	-	2009
RENAULT	SCENIC	4 CIL, 2.0 L	2004	-	2009

### T42170

CHEVROLET	AVEO	4 CIL, 1.6 L	2008	-	2009
SUZUKI	SWIFT	4 CIL, 1.6 L	2008	-	2008



### T42191

PEUGEOT	207	4 CIL, 1.6 L	2008	-	2009
---------	-----	--------------	------	---	------



### T43001

CHRYSLER	CIRRUS	4 CIL, 2.0 L	2000	-	2000
CHRYSLER	NEON	4 CIL, 2.0 L	2000	-	2002
CHRYSLER	SEBRING	4 CIL, 2.0 L	1996	-	1999
DODGE	NEON	4 CIL, 2.0 L	1996	-	2005
DODGE	STRATUS	4 CIL, 2.0 L	1996	-	2000



### T43003

FORD	CONTOUR	4 CIL, 2.0 L	1998	-	2000
FORD	ESCAPE	4 CIL, 2.0 L	2001	-	2002
FORD	ESCAPE	4 CIL, 2.0 L	2003	-	2004
FORD	ESCORT	4 CIL, 2.0 L	1998	-	2002
FORD	FOCUS	4 CIL, 2.0 L	2000	-	2004
FORD	ZX2	4 CIL, 2.0 L	2003	-	2003
MERCURY	MYSTIQUE	4 CIL, 2.0 L	1998	-	2000

### T43004



FORD	ESCORT	4 CIL, 2.0 L	1997	-	2002
FORD	FOCUS	4 CIL, 2.0 L	2000	-	2004



### T43005

CHRYSLER	CIRRUS	4 CIL, 2.4 L	1996	-	2000
CHRYSLER	PT CRUISER	4 CIL, 2.4 L	2001	-	2002
CHRYSLER	SEBRING	4 CIL, 2.4 L	1996	-	2002
CHRYSLER	VOYAGER	4 CIL, 2.4 L	2000	-	2002
DODGE	CARAVAN	4 CIL, 2.4 L	1996	-	2001
DODGE	CARAVAN	4 CIL, 2.4 L	1997	-	2002
DODGE	GRAND CARAVAN	4 CIL, 2.4 L	1996	-	1997
DODGE	STRATUS	4 CIL, 2.4 L	1996	-	2002
JEEP	LIBERTY	4 CIL, 2.4 L	2002	-	2002

### T43006



VOLKSWAGEN	GOLF	4 CIL, 1.9 L	1995	-	1998
VOLKSWAGEN	JETTA	4 CIL, 1.9 L	1995	-	1998
VOLKSWAGEN	PASSAT	4 CIL, 1.9 L	1995	-	1997

### T43007



VOLKSWAGEN	BEETLE	4 CIL, 1.9 L	1998	-	2004
VOLKSWAGEN	GOLF	4 CIL, 1.9 L	1999	-	2005
VOLKSWAGEN	JETTA	4 CIL, 1.9 L	1999	-	2004

### T43008



CHRYSLER	CIRRUS	4 CIL, 2.4 L	1997	-	2000
CHRYSLER	PT CRUISER	4 CIL, 2.4 L	2001	-	2010
CHRYSLER	SEBRING	4 CIL, 2.4 L	1997	-	2005
CHRYSLER	VOYAGER	4 CIL, 2.4 L	2000	-	2003



DODGE	CARAVAN	4 CIL, 2.4 L	1997	-	2002
DODGE	CARAVAN	4 CIL, 2.4 L	1998	-	2005
DODGE	GRAND CARAVAN	4 CIL, 2.4 L	1997	-	1997
DODGE	NEON	4 CIL, 2.4 L	2003	-	2005
DODGE	STRATUS	4 CIL, 2.4 L	1997	-	2006
DODGE	STRATUS	4 CIL, 2.4 L	2005	-	2005
JEEP	LIBERTY	4 CIL, 2.4 L	2003	-	2005
JEEP	WRANGLER	4 CIL, 2.4 L	2003	-	2006

**T43023**



**T43010**

SEAT	CORDOBA	4 CIL, 2.0 L	2003	-	2007
SEAT	IBIZA	4 CIL, 2.0 L	2003	-	2009
VOLKSWAGEN	BETLE	4 CIL, 2.0 L	1998	-	2005
VOLKSWAGEN	GOLF	4 CIL, 2.0 L	1999	-	2006
VOLKSWAGEN	JETTA	4 CIL, 2.0 L	1999	-	2005

**T43016**



SEAT	AHLAMBRA	4 CIL, 1.8 L	2003	-	2007
VOLKSWAGEN	SHARAN	4 CIL, 1.8 L	2003	-	2007

**T43017**



SEAT	AHLAMBRA	4 CIL, 1.8 L	2003	-	2007
SEAT	LEON	4 CIL, 1.8 L	2003	-	2005
SEAT	TOLEDO	4 CIL, 1.8 L	2003	-	2005
VOLKSWAGEN	SHARAN	4 CIL, 1.8 L	2003	-	2007

**T43018**



AUDI	A4	4 CIL, 1.8 L	2006	-	2006
------	----	--------------	------	---	------

**T43022**



PEUGEOT	307	4 CIL, 2.0 L	2005	-	2008
---------	-----	--------------	------	---	------

PEUGEOT	206	4 CIL, 1.4 L	1998	-	2008
---------	-----	--------------	------	---	------

**T43027**



AUDI	A4	V-6, 3.0 L	2006	-	2006
------	----	------------	------	---	------

**T43028**



AUDI	A4	4 CIL, 1.8 L	2006	-	2006
------	----	--------------	------	---	------

**T43032**



AUDI	A8	V-8, 4.2 L	2007	-	2007
VOLKSWAGEN	TOUAREG	V-8, 4.2 L	2006	-	2006

**T43039**



CHEVROLET	AVEO	4 CIL, 1.6 L	2008	-	2009
PONTIAC	G3	4 CIL, 1.6 L	2006	-	2008
SUZUKI	SWIFT	4 CIL, 1.6 L	2008	-	2008

**T43055**

FIAT	BRAVO	4 CIL, 1.4 L	2009	-	2010
FIAT	GRANDE PUNTO	4 CIL, 1.4 L	2009	-	2010



**T43064**

NISSAN	APRIO	4 CIL, 1.6 L	2008	-	2010
NISSAN	PLATINA	4 CIL, 1.6 L	2002	-	2010
RENAULT	CLIO	4 CIL, 1.6 L	2003	-	2009
RENAULT	EUROCLIO	4 CIL, 1.6 L	2007	-	2008
RENAULT	KANGOO	4 CIL, 1.6 L	2005	-	2010
RENAULT	KANGOO EXPRESS	4 CIL, 1.6 L	2005	-	2009
RENAULT	SANDERO	4 CIL, 1.6 L	2010	-	2010
RENAULT	STEPWAY	4 CIL, 1.6 L	2010	-	2010

**T43067**

VOLKSWAGEN CRAFTER

5 CIL, 2.5 L TDI 2008 - 2010

**T43068**

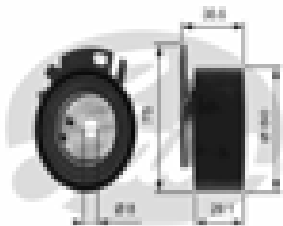

FIAT  
FIAT PALIO  
PALIO ADVENTURE

4 CIL, 1.6 L 2003 - 2006  
4 CIL, 1.6 L 2003 - 2006

**T43091**



VOLKSWAGEN BORA  
VOLKSWAGEN EUROVAN  
VOLKSWAGEN EUROVAN  
VOLKSWAGEN JETTA

4 CIL, 1.9 L DIESE2007 - 2007  
4 CIL, 1.9 L 2007 - 2008  
4 CIL, 1.9 L DIESE2005 - 2009  
4 CIL, 1.9 L DIESE2005 - 2007

**T43095**



HONDA PASSPORT

V-6, 3.2 L 1997 - 1997



**T43096**

TOYOTA	AVALON	V-6, 3.0 L	2000	-	2004
TOYOTA	CAMRY	V-6, 3.0 L	2000	-	2000
TOYOTA	CAMRY	V-6, 3.0 L	2001	-	2001
TOYOTA	CAMRY SOLARA	V-6, 3.0 L	2000	-	2000
TOYOTA	SIENNA	V-6, 3.0 L	2000	-	2003
TOYOTA	SOLARA	V-6, 3.0 L	2001	-	2003

**T43097**

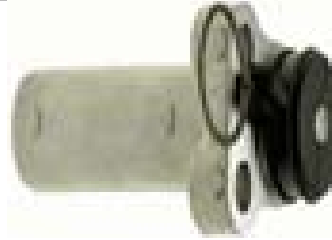

TOYOTA	4 RUNNER	V-8, 4.7 L	2003	-	2007
TOYOTA	LAND CRUISER	V-8, 4.7 L	2000	-	2002
TOYOTA	LAND CRUISER	V-8, 4.7 L	2003	-	2006
TOYOTA	SEQUOIA	V-8, 4.7 L	2001	-	2006
TOYOTA	TUNDRA	V-8, 4.7 L	2000	-	2006

**T43098**



TOYOTA	CAMRY	V-6, 3.0 L	2002	-	2006
TOYOTA	CAMRY	V-6, 3.3 L	2004	-	2006
TOYOTA	HIGHLANDER	V-6, 3.0 L	2001	-	2003
TOYOTA	HIGHLANDER	V-6, 3.3 L	2004	-	2007
TOYOTA	SIENNA	V-6, 3.3 L	2004	-	2006
TOYOTA	SOLARA	V-6, 3.3 L	2004	-	2007
TOYOTA	SOLARA	V-6, 3.3 L	2005	-	2006

**T43129**

ACURA	MDX	V-6, 3.5 L	2006	-	2006
ACURA	MDX	V-6, 3.7 L	2007	-	2010
ACURA	RL	V-6, 3.5 L	2006	-	2008
ACURA	RL	V-6, 3.7 L	2009	-	2010
ACURA	TL	V-6, 3.2 L	2006	-	2008
ACURA	TL	V-6, 3.5 L	2008	-	2010
ACURA	TL	V-6, 3.7 L	2009	-	2010
ACURA	TSX	V-6, 3.5 L	2010	-	2010
HONDA	ACCORD	V-6, 3.5 L	2008	-	2010
HONDA	ODYSSEY	V-6, 3.5 L	2008	-	2010
HONDA	PILOT	V-6, 3.5 L	2008	-	2010
HONDA	RIDGELINE	V-6, 3.5 L	2008	-	2010



**T43131**

CHRYSLER PT CRUISER 4 CIL, 2.4 L 2008 - 2010

**T43139**

VOLVO C30 5 CIL, 2.4 L 2008 - 2010  
 VOLVO C30 5 CIL, 2.5 L 2008 - 2010  
 VOLVO S40 5 CIL, 2.4 L 2005 - 2008  
 VOLVO S40 5 CIL, 2.5 L 2007 - 2008  
 VOLVO XC90 5 CIL, 2.5 L 2003 - 2006

**T43142**



SEAT ALTEA 4 CIL, 2.0 L 2006 - 2008  
 SEAT LEON 4 CIL, 2.0 L 2006 - 2007  
 SEAT TOLEDO 4 CIL, 2.0 L 2006 - 2007

**T43157**



PEUGEOT GRAND RAID 4 CIL, 1.6 L 2004 - 2008  
 PEUGEOT PARTNER 4 CIL, 1.6 L 2006 - 2008

**T43159**

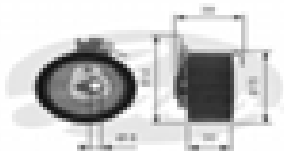

PEUGEOT 207 4 CIL, 1.6 L 2008 - 2009

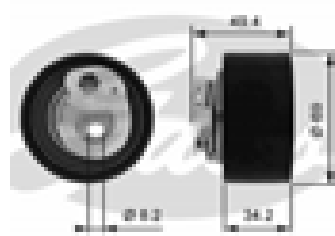

**T43163**

FIAT DUCATO 4 CIL, 2.3 L DIESE2008 - 2008  
FIAT DUCATO 4 CIL, 2.3 L DIESE2008 - 2010

**T43166**

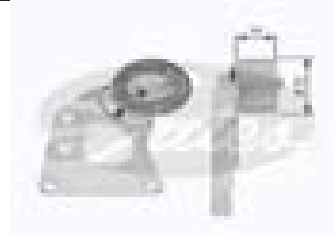

RENAULT LAGUNA V-6, 2.4 L 2004 - 2006

**T43189**

mitsubishi OUTLANDER V-6, 3.0 L 2007 - 2008

**T43190**

mitsubishi ECLIPSE V-6, 3.8 L 2007 - 2008

**T43197**

CHRYSLER 300 C V-6, 3.5 L 2007 - 2009  
 CHRYSLER TOWN & COUNTRY V-6, 4.0 L 2008 - 2010  
 DODGE CHARGER V-6, 3.5 L 2009 - 2009  
 DODGE JOURNEY V-6, 3.5 L 2009 - 2010  
 DODGE NITRO V-6, 4.0 L 2009 - 2010



**TMV-13001**



FORD	FIESTA	4 CIL, 1.6 L	2000 - 2010
FORD	IKON	4 CIL, 1.6 L	1998 - 1999
FORD	IKON	4 CIL, 1.6 L	2000 - 2007
FORD	KA	4 CIL, 1.6 L	2001 - 2007



**TMV-14001**

CHEVROLET	ASTRA	4 CIL, 1.8 L	2000 - 2003
CHEVROLET	CORSA	4 CIL, 1.4 L	2002 - 2003
CHEVROLET	CORSA	4 CIL, 1.8 L	2003 - 2009
CHEVROLET	MERIVA	4 CIL, 1.8 L	2005 - 2007
CHEVROLET	MERIVA	4 CIL, 1.8 L	2008 - 2008
CHEVROLET	TORNADO	4 CIL, 1.8 L	2003 - 2009
CHEVROLET	ZAFIRA	4 CIL, 1.8 L	2000 - 2003
FIAT	PALIO	4 CIL, 1.8 L	2006 - 2008
FIAT	PALIO ADVENTURE	4 CIL, 1.8 L	2006 - 2008



**TMV-22001**

VOLKSWAGEN	PANEL	4 CIL, 1.8 L	1998 - 2001
VOLKSWAGEN	POINTER	4 CIL, 1.8 L	1998 - 2008
VOLKSWAGEN	POINTER	4 CIL, 2.0 L	1998 - 2006
VOLKSWAGEN	POINTER PICK-UP	4 CIL, 1.8 L	1998 - 2005
VOLKSWAGEN	POINTER PICK-UP	4 CIL, 1.8 L	2006 - 2006
VOLKSWAGEN	POINTER PICK-UP	4 CIL, 2.0 L	1998 - 2006



**TMV-22002**

VOLKSWAGEN	PANEL	4 CIL, 1.8 L	1998 - 2001
VOLKSWAGEN	POINTER	4 CIL, 1.8 L	1998 - 2008
VOLKSWAGEN	POINTER	4 CIL, 2.0 L	1998 - 2006
VOLKSWAGEN	POINTER PICK-UP	4 CIL, 1.8 L	1998 - 2005
VOLKSWAGEN	POINTER PICK-UP	4 CIL, 1.8 L	2006 - 2006
VOLKSWAGEN	POINTER PICK-UP	4 CIL, 2.0 L	1998 - 2006



**TMV-23001**

SEAT	CORDOBA	4 CIL, 1.6 L	2003 - 2008
SEAT	IBIZA	4 CIL, 1.6 L	2003 - 2009
VOLKSWAGEN	CROSSFOX	4 CIL, 1.6 L	2006 - 2008
VOLKSWAGEN	DERBY	4 CIL, 1.6 L	2000 - 2005
VOLKSWAGEN	LUPO	4 CIL, 1.6 L	2004 - 2008
VOLKSWAGEN	POLO	4 CIL, 1.6 L	2003 - 2007
VOLKSWAGEN	SPORTVAN	4 CIL, 1.6 L	2006 - 2008

VOLKSWAGEN	VW VAN	4 CIL, 1.6 L	2003 - 2006
------------	--------	--------------	-------------



**TPG-14001**

CHEVROLET	ASTRA	4 CIL, 2.0 L	2004 - 2006
CHEVROLET	OPTRA	4 CIL, 2.0 L	2006 - 2010
CHEVROLET	VECTRA	4 CIL, 2.0 L	2004 - 2005
CHEVROLET	ZAFIRA	4 CIL, 2.0 L	2004 - 2006



**TPG-14002**

CHEVROLET	ASTRA	4 CIL, 2.4 L	2004 - 2006
CHEVROLET	ZAFIRA	4 CIL, 2.4 L	2004 - 2006



**TPG-14003**

CHEVROLET	CHEVY	4 CIL, 1.6 L	2000 - 2005
CHEVROLET	CHEVY	4 CIL, 1.6 L	2009 - 2010
CHEVROLET	CHEVY C2	4 CIL, 1.6 L	2004 - 2008
CHEVROLET	CHEVY C2 SEDAN	4 CIL, 1.6 L	2004 - 2008
CHEVROLET	CHEVY JOY	4 CIL, 1.6 L	1994 - 2003
CHEVROLET	CHEVY MILENIO	4 CIL, 1.6 L	2000 - 2000
CHEVROLET	CHEVY PICK-UP	4 CIL, 1.6 L	2002 - 2006
CHEVROLET	CHEVY POP	4 CIL, 1.6 L	1994 - 2003
CHEVROLET	CHEVY SWING	4 CIL, 1.6 L	1994 - 2003
CHEVROLET	CHEVY WAGON	4 CIL, 1.6 L	2000 - 2003
CHEVROLET	MONZA	4 CIL, 1.6 L	1994 - 2004



**TPG-14004**

CHEVROLET	ASTRA	4 CIL, 1.8 L	2000 - 2003
CHEVROLET	CORSA	4 CIL, 1.4 L	2002 - 2003
CHEVROLET	CORSA	4 CIL, 1.8 L	2003 - 2009
CHEVROLET	MERIVA	4 CIL, 1.8 L	2005 - 2007
CHEVROLET	MERIVA	4 CIL, 1.8 L	2008 - 2008
CHEVROLET	TORNADO	4 CIL, 1.8 L	2003 - 2007
CHEVROLET	TORNADO	4 CIL, 1.8 L	2008 - 2009
CHEVROLET	ZAFIRA	4 CIL, 1.8 L	2000 - 2003
FIAT	PALIO	4 CIL, 1.8 L	2006 - 2008
FIAT	PALIO ADVENTURE	4 CIL, 1.8 L	2006 - 2008





## TPG-20001

RENAULT	CLIO	4 CIL, 2.0 L SPOR	2003	-	2006
RENAULT	LAGUNA	4 CIL, 2.0 L	2001	-	2004
RENAULT	MEGANE	4 CIL, 2.0 L	2009	-	2009
RENAULT	MEGANE	4 CIL, 2.0 L	2001	-	2008
RENAULT	MEGANE I y II	4 CIL, 2.0 L	2001	-	2006
RENAULT	SCENIC	4 CIL, 2.0 L	2009	-	2009
RENAULT	SCENIC	4 CIL, 2.0 L	2001	-	2007
RENAULT	SCENIC I y II	4 CIL, 2.0 L	2001	-	2006



## TPG-22001

VOLKSWAGEN	EUROVAN	5 CIL, 2.5 L	2000	-	2000
VOLKSWAGEN	EUROVAN	5 CIL, 2.5 L	2001	-	2005



## TPG-23001

SEAT	CORDOBA	4 CIL, 1.6 L	2003	-	2008
SEAT	IBIZA	4 CIL, 1.6 L	2003	-	2009
VOLKSWAGEN	DERBY	4 CIL, 1.6 L	2000	-	2005
VOLKSWAGEN	GOL	4 CIL, 1.6 L	2009	-	2010
VOLKSWAGEN	LUPO	4 CIL, 1.6 L	2004	-	2008
VOLKSWAGEN	POLO	4 CIL, 1.6 L	2003	-	2007
VOLKSWAGEN	SAVEIRO	4 CIL, 1.6 L	2010	-	2010
VOLKSWAGEN	VW VAN	4 CIL, 1.6 L	2003	-	2005



A Tomkins Company

# Aplicación por producto servicio pesado



La marca de más prestigio en bandas, Mangueras, Hidráulica y Neumática



Tensores y Poleas

36091



BLUEBIRD	All American RE	Caterpillar 3126 Diesel	2003 - 2004
BLUEBIRD	All American RE	Caterpillar C7 Diesel	2005 - 2006
BLUEBIRD	All American RE	Cummins ISC Diesel	1998 - 2000
BLUEBIRD	All American RE	John Deere 6-Cyl. 8.1 L CNG	2000 - 2003
BLUEBIRD	Conventional	International/Navistar DT466 Diesel	1999 - 2004
BLUEBIRD	TC2000	Caterpillar 3126 Diesel	1998 - 1998
CHEVROLET	C5500	Caterpillar 3116 Diesel	1999 - 1999
CHEVROLET	C5500	Caterpillar 3126 Diesel	1998 - 2002
CHEVROLET	C6500	Caterpillar 3116 Diesel	1997 - 2000
CHEVROLET	C6500	Caterpillar 3126 Diesel	1998 - 2003
CHEVROLET	C7500	Caterpillar 3116 Diesel	1997 - 2000
CHEVROLET	C7500	Caterpillar 3126 Diesel	1998 - 2003
CHEVROLET	C8500	Caterpillar 3116 Diesel	1997 - 2000
CHEVROLET	C8500	Caterpillar 3126 Diesel	1998 - 2003
CHEVROLET	KODIAK	CATERPILLAR 3116 DIESEL	1997 - 2000
CHEVROLET	KODIAK	CATERPILLAR 3126 DIESEL	2000 - 2008
CHEVROLET	Kodiak C6500	Caterpillar 3116 Diesel	1991 - 1996
CHEVROLET	Kodiak C7500	Caterpillar 3116 Diesel	1991 - 1996
CHEVROLET	Kodiak C8500	Caterpillar 3116 Diesel	1991 - 1996
FORD	F650 Super Duty	Caterpillar 3126 Diesel	2000 - 2004
FORD	F750 Super Duty	Caterpillar 3126 Diesel	2000 - 2004
FREIGHTLINER	Argosy	Caterpillar C10 Diesel	1999 - 2003
FREIGHTLINER	Argosy	Caterpillar C12 Diesel	1999 - 2004
FREIGHTLINER	Argosy	Caterpillar C15 Diesel	2001 - 2004
FREIGHTLINER	Business Class M2	Caterpillar 3126 Diesel	2007 - 2007
FREIGHTLINER	Business Class M2	Caterpillar C7 Diesel	2004 - 2007
FREIGHTLINER	Century Class	Caterpillar 3406 Diesel	1998 - 1999
FREIGHTLINER	Century Class	Caterpillar C10 Diesel	1998 - 2003
FREIGHTLINER	Century Class	Caterpillar C12 Diesel	1998 - 2004
FREIGHTLINER	Century Class	Caterpillar C15 Diesel	2001 - 2007
FREIGHTLINER	Century Class	Cummins ISM Diesel	1998 - 2001
FREIGHTLINER	Classic	Caterpillar C10 Diesel	2001 - 2003
FREIGHTLINER	Classic	Caterpillar C12 Diesel	2001 - 2004
FREIGHTLINER	Classic	Caterpillar C15 Diesel	2001 - 2007
FREIGHTLINER	Classic	Caterpillar C16 Diesel	2001 - 2003
FREIGHTLINER	Classic	Cummins ISM Diesel	2001 - 2003
FREIGHTLINER	Classic XL	Caterpillar C10 Diesel	2001 - 2003
FREIGHTLINER	Classic XL	Caterpillar C12 Diesel	2001 - 2003
FREIGHTLINER	Classic XL	Caterpillar C15 Diesel	2001 - 2007
FREIGHTLINER	Classic XL	Caterpillar C16 Diesel	2001 - 2003
FREIGHTLINER	Classic XL	Cummins ISM Diesel	2001 - 2003
FREIGHTLINER	Columbia	Caterpillar C10 Diesel	2001 - 2003
FREIGHTLINER	Columbia	Caterpillar C12 Diesel	2001 - 2004
FREIGHTLINER	Columbia	Caterpillar C15 Diesel	2001 - 2008
FREIGHTLINER	Columbia	Caterpillar C16 Diesel	2001 - 2004
FREIGHTLINER	Columbia	Cummins ISM Diesel	2001 - 2003
FREIGHTLINER	Condor	Caterpillar C10 Diesel	2001 - 2004
FREIGHTLINER	Condor	Caterpillar C12 Diesel	2001 - 2004
FREIGHTLINER	Condor	Caterpillar C7 Diesel	2005 - 2005
FREIGHTLINER	Condor	Cummins ISM Diesel	2001 - 2002
FREIGHTLINER	Coronado	Caterpillar C15 Diesel	2002 - 2007
FREIGHTLINER	Coronado	Caterpillar C16 Diesel	2002 - 2003
FREIGHTLINER	FL112	Caterpillar C10 Diesel	1999 - 2004
FREIGHTLINER	FL112	Caterpillar C12 Diesel	1999 - 2004
FREIGHTLINER	FL112	Cummins ISM Diesel	1999 - 2003
FREIGHTLINER	FL50	Caterpillar 3126 Diesel	1995 - 2004
FREIGHTLINER	FL50	Caterpillar C7 Diesel	2004 - 2004
FREIGHTLINER	FL50	Cummins ISC Diesel	1998 - 1998
FREIGHTLINER	FL60	Caterpillar 3126 Diesel	1995 - 2004
FREIGHTLINER	FL60	Caterpillar C7 Diesel	2004 - 2005
FREIGHTLINER	FL60	Cummins ISC Diesel	1998 - 1998
FREIGHTLINER	FL70	Caterpillar 3126 Diesel	1995 - 2004
FREIGHTLINER	FL70	Caterpillar C7 Diesel	2004 - 2005
FREIGHTLINER	FL70	Cummins ISC Diesel	1998 - 1998

FREIGHTLINER	FL80	Caterpillar 3126 Diesel	1995 - 2005
FREIGHTLINER	FL80	Caterpillar C7 Diesel	2004 - 2005
FREIGHTLINER	FL80	Cummins C Series 8.3 L Diesel	1997 - 1997
FREIGHTLINER	FL80	Cummins ISC Diesel	1998 - 1999
FREIGHTLINER	FLD	Caterpillar 3406 Diesel	1998 - 2000
FREIGHTLINER	FLD	Caterpillar C10 Diesel	1997 - 2004
FREIGHTLINER	FLD	Caterpillar C12 Diesel	1996 - 2004
FREIGHTLINER	FLD	Caterpillar C15 Diesel	2000 - 2008
FREIGHTLINER	FLD	Caterpillar C16 Diesel	2000 - 2004
FREIGHTLINER	FLD	Cummins ISM Diesel	1999 - 2003
FREIGHTLINER	FLD	Cummins ISX Diesel	2001 - 2001
INTERNATIONAL/NAVIS	3300	International/Navistar DT466 Diesel	2004 - 2004
INTERNATIONAL/NAVIS	3800	International/Navistar DT466 Diesel	1998 - 2001
INTERNATIONAL/NAVIS	4300	International/Navistar DT466 Diesel	2002 - 2004
INTERNATIONAL/NAVIS	4400	International/Navistar 530 Diesel	2002 - 2005
INTERNATIONAL/NAVIS	4400	International/Navistar DT466 Diesel	2002 - 2005
INTERNATIONAL/NAVIS	4700	International/Navistar 530 Diesel	1999 - 2002
INTERNATIONAL/NAVIS	4700	International/Navistar DT408 Diesel	1995 - 1997
INTERNATIONAL/NAVIS	4700	International/Navistar DT466 Diesel	1995 - 2002
INTERNATIONAL/NAVIS	4800	International/Navistar 530 Diesel	2002 - 2002
INTERNATIONAL/NAVIS	4800	International/Navistar DT408 Diesel	1995 - 1997
INTERNATIONAL/NAVIS	4800	International/Navistar DT466 Diesel	1995 - 2003
INTERNATIONAL/NAVIS	4900	International/Navistar 530 Diesel	1995 - 2002
INTERNATIONAL/NAVIS	4900	International/Navistar DT408 Diesel	1995 - 1997
INTERNATIONAL/NAVIS	4900	International/Navistar DT466 Diesel	1995 - 2002
INTERNATIONAL/NAVIS	5000	Caterpillar C12 Diesel	1998 - 1999
INTERNATIONAL/NAVIS	5500i	Caterpillar C10 Diesel	2003 - 2004
INTERNATIONAL/NAVIS	5500i	Caterpillar C12 Diesel	2003 - 2004
INTERNATIONAL/NAVIS	5500i	Cummins ISM Diesel	2002 - 2006
INTERNATIONAL/NAVIS	5500i	International/Navistar DT466 Diesel	2001 - 2002
INTERNATIONAL/NAVIS	5600i	Caterpillar C10 Diesel	2002 - 2004
INTERNATIONAL/NAVIS	5600i	Caterpillar C12 Diesel	2003 - 2004
INTERNATIONAL/NAVIS	5600i	Caterpillar C15 Diesel	2004 - 2004
INTERNATIONAL/NAVIS	5600i	Cummins ISM Diesel	2002 - 2007
INTERNATIONAL/NAVIS	5600i	International/Navistar DT466 Diesel	2001 - 2002
INTERNATIONAL/NAVIS	5900i	Caterpillar C10 Diesel	2000 - 2003
INTERNATIONAL/NAVIS	5900i	Caterpillar C12 Diesel	2002 - 2004
INTERNATIONAL/NAVIS	5900i	Caterpillar C15 Diesel	2004 - 2006
INTERNATIONAL/NAVIS	5900i	Cummins ISM Diesel	2001 - 2006
INTERNATIONAL/NAVIS	5900i	International/Navistar DT466 Diesel	1995 - 1995
INTERNATIONAL/NAVIS	7100	International/Navistar DT466 Diesel	2002 - 2003
INTERNATIONAL/NAVIS	7300	Cummins ISM Diesel	2005 - 2005
INTERNATIONAL/NAVIS	7400	International/Navistar 530 Diesel	2002 - 2003
INTERNATIONAL/NAVIS	7400	International/Navistar DT466 Diesel	2002 - 2003
INTERNATIONAL/NAVIS	7400	International/Navistar DT530 Diesel	2004 - 2005
INTERNATIONAL/NAVIS	7400	International/Navistar 530 Diesel	2002 - 2003
INTERNATIONAL/NAVIS	7500	International/Navistar DT466 Diesel	2002 - 2002
INTERNATIONAL/NAVIS	7500	International/Navistar DT530 Diesel	2004 - 2005
INTERNATIONAL/NAVIS	7500	Caterpillar C10 Diesel	2002 - 2004
INTERNATIONAL/NAVIS	7600	Caterpillar C12 Diesel	2002 - 2004
INTERNATIONAL/NAVIS	7600	Cummins ISM Diesel	2003 - 2007
INTERNATIONAL/NAVIS	7600	Cummins ISM Diesel	2005 - 2006
INTERNATIONAL/NAVIS	7700	Caterpillar 3176 Diesel	1995 - 1997
INTERNATIONAL/NAVIS	8100	Caterpillar C10 Diesel	2002 - 2003
INTERNATIONAL/NAVIS	8100	International/Navistar 530 Diesel	1995 - 2003
INTERNATIONAL/NAVIS	8100	International/Navistar DT466 Diesel	1995 - 2000
INTERNATIONAL/NAVIS	8200	Detroit Diesel 6-Cyl. 11.1 L Diesel	1995 - 1995
INTERNATIONAL/NAVIS	8200	Detroit Diesel 6-Cyl. 12.7 L Diesel	1995 - 1995
INTERNATIONAL/NAVIS	8200	International/Navistar 530 Diesel	1996 - 1997
INTERNATIONAL/NAVIS	8200	International/Navistar DT466 Diesel	1997 - 1997
INTERNATIONAL/NAVIS	8500	International/Navistar 530 Diesel	2002 - 2005
INTERNATIONAL/NAVIS	8600	Caterpillar C10 Diesel	2003 - 2004
INTERNATIONAL/NAVIS	8600	Caterpillar C12 Diesel	2003 - 2004
INTERNATIONAL/NAVIS	8600	Cummins ISM Diesel	2003 - 2007
INTERNATIONAL/NAVIS	9200	Caterpillar 3176 Diesel	1995 - 1995
INTERNATIONAL/NAVIS	9200i	Caterpillar C10 Diesel	2004 - 2004
INTERNATIONAL/NAVIS	9200i	Caterpillar C12 Diesel	2003 - 2004
INTERNATIONAL/NAVIS	9200i	Cummins ISM Diesel	2003 - 2007
INTERNATIONAL/NAVIS	9300	Caterpillar 3176 Diesel	1995 - 1995
INTERNATIONAL/NAVIS	9400	Caterpillar 3176 Diesel	1995 - 1995
INTERNATIONAL/NAVIS	9400i	Caterpillar C15 Diesel	2004 - 2007
INTERNATIONAL/NAVIS	9400i	Cummins ISM Diesel	2004 - 2007
INTERNATIONAL/NAVIS	9900i	Caterpillar C12 Diesel	2003 - 2004
INTERNATIONAL/NAVIS	9900i	Caterpillar C15 Diesel	2004 - 2007
INTERNATIONAL/NAVIS	9900ix	Caterpillar C12 Diesel	2003 - 2003
INTERNATIONAL/NAVIS	9900ix	Caterpillar C15 Diesel	2004 - 2007
INTERNATIONAL/NAVIS	CE	International/Navistar DT466 Diesel	2003 - 2004
INTERNATIONAL/NAVIS	Conventional IC	International/Navistar DT466 Diesel	2002 - 2003



INTERNATIONAL/NAVIS' FE	International/Navistar DT466 Diesel	2002 - 2004
INTERNATIONAL/NAVIS' PayStar 5600i	Caterpillar C15 Diesel	2008 - 2008
INTERNATIONAL/NAVIS' RE	International/Navistar 530 Diesel	1998 - 2004
INTERNATIONAL/NAVIS' TranStar 8600	Cummins ISM Diesel	2008 - 2008
INTERNATIONAL/NAVIS' WorkStar 7600	Cummins ISM Diesel	2008 - 2008
KENWORTH T2000	Caterpillar C10 Diesel	1997 - 1999
KENWORTH T2000	Caterpillar C12 Diesel	1997 - 1999
KENWORTH T2000	Caterpillar C15 Diesel	2004 - 2007
KENWORTH T300	Caterpillar 3126 Diesel	1996 - 2003
KENWORTH T300	Caterpillar C7 Diesel	2004 - 2006
KENWORTH T600	Caterpillar C10 Diesel	1997 - 2004
KENWORTH T600	Caterpillar C12 Diesel	1996 - 2004
KENWORTH T600	Caterpillar C15 Diesel	2000 - 2007
KENWORTH T600	Cummins ISM Diesel	2006 - 2008
KENWORTH T660	Caterpillar C15 Diesel	2007 - 2007
KENWORTH T800	Caterpillar C10 Diesel	1997 - 2004
KENWORTH T800	Caterpillar C12 Diesel	1996 - 2004
KENWORTH T800	Caterpillar C15 Diesel	2004 - 2007
KENWORTH T800	Cummins ISM Diesel	2003 - 2006
KENWORTH W900	Caterpillar C10 Diesel	1997 - 2004
KENWORTH W900	Caterpillar C12 Diesel	2000 - 2004
KENWORTH W900	Caterpillar C15 Diesel	2004 - 2008
KENWORTH W900	Cummins ISM Diesel	2003 - 2006
PETERBILT 320	Caterpillar C7 Diesel	2004 - 2007
PETERBILT 320	Cummins ISM Diesel	2007 - 2007
PETERBILT 330	Caterpillar 3126 Diesel	1998 - 2003
PETERBILT 330	Caterpillar C7 Diesel	2004 - 2007
PETERBILT 335	Caterpillar C7 Diesel	2005 - 2007
PETERBILT 357	Caterpillar C10 Diesel	1997 - 2004
PETERBILT 357	Caterpillar C12 Diesel	1997 - 2004
PETERBILT 357	Caterpillar C15 Diesel	2004 - 2007
PETERBILT 357	Cummins ISC Diesel	2001 - 2001
PETERBILT 357	Cummins ISM Diesel	2003 - 2007
PETERBILT 362	Caterpillar C10 Diesel	1996 - 1998
PETERBILT 362	Caterpillar C12 Diesel	1996 - 1998
PETERBILT 365	Cummins ISM Diesel	2007 - 2007
PETERBILT 377	Caterpillar C10 Diesel	1997 - 1998
PETERBILT 377	Caterpillar C12 Diesel	1997 - 1998
PETERBILT 378	Caterpillar C10 Diesel	2000 - 2004
PETERBILT 378	Caterpillar C12 Diesel	2000 - 2004
PETERBILT 378	Caterpillar C15 Diesel	2003 - 2007
PETERBILT 378	Cummins ISM Diesel	2001 - 2007
PETERBILT 379	Caterpillar C10 Diesel	2000 - 2004
PETERBILT 379	Caterpillar C12 Diesel	2000 - 2004
PETERBILT 379	Caterpillar C15 Diesel	2004 - 2007
PETERBILT 385	Caterpillar C10 Diesel	1997 - 2004
PETERBILT 385	Caterpillar C12 Diesel	1996 - 2004
PETERBILT 385	Cummins ISM Diesel	2002 - 2005
PETERBILT 386	Caterpillar C15 Diesel	2006 - 2007
PETERBILT 387	Caterpillar C10 Diesel	2000 - 2002
PETERBILT 387	Caterpillar C12 Diesel	2000 - 2002
PETERBILT 387	Caterpillar C15 Diesel	2001 - 2007
PETERBILT 387	Caterpillar C16 Diesel	2001 - 2003
PETERBILT 387	Cummins ISM Diesel	2000 - 2000
PETERBILT 388	Caterpillar C15 Diesel	2007 - 2007
STERLING Acterra	Caterpillar 3126 Diesel	2001 - 2003
STERLING Acterra	Caterpillar C7 Diesel	2004 - 2007
STERLING A-Line	Caterpillar C10 Diesel	2002 - 2004
STERLING A-Line	Caterpillar C12 Diesel	2002 - 2004
STERLING A-Line	Caterpillar C15 Diesel	2004 - 2007
STERLING L-LINE	CATERPILLAR 3126 DIESEL	2001 - 2004
STERLING L-Line	Caterpillar C15 Diesel	2004 - 2007
STERLING L-Line	Caterpillar C7 Diesel	2004 - 2007
STERLING L-Line	Caterpillar C9 Diesel	2006 - 2006
STERLING L-Line	Cummins ISC Diesel	2000 - 2003
THOMAS BUILT Conventional	Caterpillar 3126 Diesel	1998 - 2003
THOMAS BUILT Saf-T-Liner C2	Caterpillar C7 Diesel	2008 - 2008
THOMAS BUILT Saf-T-Liner MVP EF	Caterpillar 3126 Diesel	1998 - 2004
THOMAS BUILT Saf-T-Liner MVP EF	Cummins ISB Diesel	2000 - 2002
THOMAS BUILT Saf-T-Liner MVP ER	Caterpillar 3126 Diesel	2001 - 2004
THOMAS BUILT Saf-T-Liner MVP ER	Cummins ISC Diesel	1998 - 1998
THOMAS BUILT Saf-T-Liner MVP ER	John Deere 6-Cyl. 8.1 L CNG	2001 - 2003
VOLVO Autocar	Detroit Diesel 6-Cyl. 11.1 L Diesel	1998 - 1998
VOLVO Autocar	Detroit Diesel 6-Cyl. 12.7 L Diesel	1998 - 1998
VOLVO VN Series	Caterpillar 3406 Diesel	1999 - 1999
VOLVO VN Series	Detroit Diesel 6-Cyl. 11.1 L Diesel	1998 - 2001
VOLVO VN Series	Detroit Diesel 6-Cyl. 12.7 L Diesel	1998 - 2001

FREIGHTLINER Argosy	1999 - 2003	
FREIGHTLINER Century Class	2000 - 2001	
FREIGHTLINER Columbia	2001 - 2001	
FREIGHTLINER FLD	1999 - 2003	
INTERNATIONAL/NAVIS' 9100	Detroit Diesel Series 60 Diesel	1998 - 1999
INTERNATIONAL/NAVIS' 9100i	Cummins ISX Diesel	2001 - 2003
INTERNATIONAL/NAVIS' 9100i	Detroit Diesel 6-Cyl. 12.7 L Diesel	2001 - 2003
INTERNATIONAL/NAVIS' 9100i	Detroit Diesel Series 60 Diesel	2000 - 2000
INTERNATIONAL/NAVIS' 9100i	Detroit Diesel 6-Cyl. 11.1 L Diesel	1995 - 1997
INTERNATIONAL/NAVIS' 9200	Detroit Diesel 6-Cyl. 12.7 L Diesel	1995 - 1997
INTERNATIONAL/NAVIS' 9200	Detroit Diesel Series 60 Diesel	1998 - 1999
INTERNATIONAL/NAVIS' 9200i	Cummins Signature 600 Diesel	2000 - 2002
INTERNATIONAL/NAVIS' 9200i	Detroit Diesel 6-Cyl. 12.7 L Diesel	2001 - 2001
INTERNATIONAL/NAVIS' 9200i	Detroit Diesel Series 60 Diesel	2000 - 2000
INTERNATIONAL/NAVIS' 9400	Detroit Diesel 6-Cyl. 11.1 L Diesel	1995 - 1996
INTERNATIONAL/NAVIS' 9400	Detroit Diesel 6-Cyl. 12.7 L Diesel	1995 - 1996
INTERNATIONAL/NAVIS' 9400	Detroit Diesel Series 60 Diesel	1997 - 1999
INTERNATIONAL/NAVIS' 9400i	Cummins ISX Diesel	2000 - 2002
INTERNATIONAL/NAVIS' 9400i	Detroit Diesel 6-Cyl. 12.7 L Diesel	2001 - 2001
INTERNATIONAL/NAVIS' 9400i	Detroit Diesel Series 60 Diesel	2000 - 2000
INTERNATIONAL/NAVIS' 9400i	Detroit Diesel 6-Cyl. 11.1 L Diesel	1996 - 1996
INTERNATIONAL/NAVIS' 9600	Detroit Diesel 6-Cyl. 12.7 L Diesel	1995 - 1995
INTERNATIONAL/NAVIS' 9600	Detroit Diesel 6-Cyl. 11.1 L Diesel	1996 - 1996
INTERNATIONAL/NAVIS' 9700	Detroit Diesel 6-Cyl. 12.7 L Diesel	1996 - 1996
INTERNATIONAL/NAVIS' 9700	Detroit Diesel Series 60 Diesel	1997 - 1997
INTERNATIONAL/NAVIS' 9800	Detroit Diesel Series 60 Diesel	1999 - 1999
INTERNATIONAL/NAVIS' 9900	Cummins ISX Diesel	2000 - 2003
INTERNATIONAL/NAVIS' 9900i	Detroit Diesel 6-Cyl. 12.7 L Diesel	2001 - 2001
INTERNATIONAL/NAVIS' 9900i	Detroit Diesel Series 60 Diesel	2000 - 2000
INTERNATIONAL/NAVIS' 9900i	Cummins ISX Diesel	2000 - 2003
INTERNATIONAL/NAVIS' 9900ix	Detroit Diesel 6-Cyl. 12.7 L Diesel	2001 - 2001
INTERNATIONAL/NAVIS' 9900ix	Detroit Diesel Series 60 Diesel	2000 - 2000
INTERNATIONAL/NAVIS' Conventional IC	International/Navistar T444 Diesel	2003 - 2003
KENWORTH T2000	Cummins ISX Diesel	1999 - 2003
KENWORTH T600	Cummins ISX Diesel	2002 - 2003
KENWORTH T600	Cummins Signature 600 Diesel	2003 - 2003
KENWORTH T800	Cummins ISX Diesel	1999 - 2003
KENWORTH W900	Cummins ISX Diesel	1999 - 2003
KENWORTH W900	Cummins Signature 600 Diesel	2000 - 2002
MACK CH Series	Cummins Signature 600 Diesel	2001 - 2003
MACK CH Series	Mack 6-Cyl. 12.0 L Diesel	2001 - 2002
MACK CH Series	Mack AC Diesel	2003 - 2006
MACK CHN Series	Mack AC Diesel	2006 - 2007
MACK CL Series	Cummins Signature 600 Diesel	2001 - 2003
MACK CL Series	Mack 6-Cyl. 12.0 L Diesel	2001 - 2001
MACK CS Series	Mack AC Diesel	2003 - 2003
MACK CT Series	Mack AI Diesel	2006 - 2007
MACK CT Series	Mack AMI Diesel	2006 - 2006
MACK CV Series	Mack 6-Cyl. 12.0 L Diesel	2001 - 2002
MACK CV Series	Mack AI Diesel	2003 - 2007
MACK CV Series	Mack AMI Diesel	2003 - 2006
MACK CX Series	Mack 6-Cyl. 12.0 L Diesel	2001 - 2002
MACK CX Series	Mack AC Diesel	2003 - 2006
MACK CXN Series	Mack AC Diesel	2006 - 2007
MACK DM Series	Mack 6-Cyl. 12.0 L Diesel	2001 - 2001
MACK LE Series	Mack AI Diesel	2003 - 2005
MACK MR Series	Mack 6-Cyl. 12.0 L Diesel	2001 - 2002
MACK RD Series	Mack 6-Cyl. 12.0 L Diesel	2001 - 2002
MACK RD Series	Mack E7 Diesel	2003 - 2003
PETERBILT 378	Cummins ISX Diesel	2000 - 2002
PETERBILT 378	Cummins Signature 600 Diesel	2000 - 2002
PETERBILT 379	Cummins ISX Diesel	1998 - 2002
PETERBILT 379	Cummins Signature 600 Diesel	2000 - 2002
PETERBILT 387	Cummins ISX Diesel	2001 - 2002
PETERBILT 387	Cummins Signature 600 Diesel	2001 - 2002
PETERBILT 387	Cummins ISX Diesel	2001 - 2002
STERLING L-Line	Cummins Signature 600 Diesel	2001 - 2002
STERLING L-LINE	Cummins ISX Diesel	2001 - 2001
STERLING L-LINE	CUMMINS SIGNATURE 600	2001 - 2001



STERLING	L-Line	Cummins Signature 600 Diesel	2001 - 2001	KENWORTH	T800	Cummins ISL Diesel	2001 - 2008
VOLVO	VHD	Cummins ISM Diesel	2002 - 2003	KENWORTH	W900	Caterpillar C11 Diesel	2005 - 2007
VOLVO	VN Series	Cummins ISM Diesel	2002 - 2003	KENWORTH	W900	Caterpillar C13 Diesel	2004 - 2007
VOLVO	VN Series	Cummins ISX Diesel	2000 - 2003	KENWORTH	W900	Caterpillar C15 Diesel	2004 - 2008
VOLVO	VN Series	Cummins Signature 600 Diesel	2003 - 2003	KENWORTH	W900	Cummins ISC Diesel	2003 - 2004

**36093**



BLUEBIRD	All American RE	Cummins ISB Diesel	1999 - 1999	PETERBILT	330	Cummins ISC Diesel	1999 - 2005
BLUEBIRD	All American RE	Cummins ISC Diesel	2001 - 2003	PETERBILT	335	Cummins ISC Diesel	2005 - 2006
BLUEBIRD	Conventional	Cummins ISB Diesel	2001 - 2001	PETERBILT	357	Caterpillar C11 Diesel	2005 - 2007
BLUEBIRD	TC2000	Cummins ISB Diesel	1998 - 2000	PETERBILT	357	Caterpillar C13 Diesel	2005 - 2007
FORD	F650 Super Duty	Cummins ISB Diesel	2000 - 2004	PETERBILT	357	Caterpillar C15 Diesel	2004 - 2007
FORD	F750 Super Duty	Cummins ISB Diesel	2000 - 2004	PETERBILT	378	Caterpillar C11 Diesel	2004 - 2007
FREIGHTLINER	Business Class M2	Caterpillar C13 Diesel	2004 - 2007	PETERBILT	378	Caterpillar C13 Diesel	2005 - 2006
FREIGHTLINER	Business Class M2	Cummins ISC Diesel	2004 - 2004	PETERBILT	378	Caterpillar C15 Diesel	2004 - 2007
FREIGHTLINER	Century Class	Caterpillar C11 Diesel	2004 - 2006	PETERBILT	379	Caterpillar C11 Diesel	2005 - 2006
FREIGHTLINER	Century Class	Caterpillar C13 Diesel	2004 - 2007	PETERBILT	379	Caterpillar C13 Diesel	2004 - 2006
FREIGHTLINER	Century Class	Caterpillar C15 Diesel	2004 - 2007	PETERBILT	385	Caterpillar C15 Diesel	2004 - 2007
FREIGHTLINER	Classic	Caterpillar C11 Diesel	2004 - 2006	PETERBILT	385	Caterpillar C11 Diesel	2005 - 2007
FREIGHTLINER	Classic	Caterpillar C13 Diesel	2004 - 2007	PETERBILT	386	Caterpillar C13 Diesel	2007 - 2007
FREIGHTLINER	Classic	Caterpillar C15 Diesel	2004 - 2007	PETERBILT	386	Caterpillar C15 Diesel	2006 - 2007
FREIGHTLINER	Classic XL	Caterpillar C11 Diesel	2004 - 2006	PETERBILT	387	Caterpillar C11 Diesel	2006 - 2006
FREIGHTLINER	Classic XL	Caterpillar C13 Diesel	2004 - 2006	PETERBILT	387	Caterpillar C13 Diesel	2004 - 2006
FREIGHTLINER	Classic XL	Caterpillar C15 Diesel	2004 - 2007	PETERBILT	387	Caterpillar C15 Diesel	2007 - 2007
FREIGHTLINER	Columbia	Caterpillar C11 Diesel	2004 - 2007	STERLING	Acterra	Caterpillar C13 Diesel	2004 - 2006
FREIGHTLINER	Columbia	Caterpillar C13 Diesel	2004 - 2008	STERLING	Acterra	Cummins ISC Diesel	2005 - 2008
FREIGHTLINER	Columbia	Caterpillar C15 Diesel	2004 - 2008	STERLING	A-Line	Caterpillar C11 Diesel	2004 - 2007
FREIGHTLINER	Condor	Caterpillar C11 Diesel	2004 - 2005	STERLING	A-Line	Caterpillar C13 Diesel	2004 - 2007
FREIGHTLINER	Condor	Caterpillar C13 Diesel	2004 - 2005	STERLING	A-Line	Caterpillar C15 Diesel	2004 - 2007
FREIGHTLINER	Condor	Caterpillar C15 Diesel	2004 - 2005	STERLING	L-Line	Caterpillar C11 Diesel	2004 - 2007
FREIGHTLINER	Coronado	Caterpillar C11 Diesel	2004 - 2007	STERLING	L-Line	Caterpillar C13 Diesel	2004 - 2007
FREIGHTLINER	FL50	Cummins B Series 5.9 L Diesel	1997 - 1997	STERLING	L-Line	Caterpillar C15 Diesel	2004 - 2007
FREIGHTLINER	FL50	Cummins ISB Diesel	1998 - 2003	STERLING	L-Line	Cummins ISB Diesel	2000 - 2000
FREIGHTLINER	FL50	Cummins ISC Diesel	1999 - 2005	THOMAS BUILT	Conventional	Cummins ISB Diesel	2000 - 2003
FREIGHTLINER	FL60	Cummins B Series 5.9 L Diesel	1997 - 1997	THOMAS BUILT	Saf-T-Liner C2	Caterpillar C7 Diesel	2008 - 2008
FREIGHTLINER	FL60	Cummins ISB Diesel	1998 - 2003	THOMAS BUILT	Saf-T-Liner MVP EF	Cummins ISB Diesel	2000 - 2002
FREIGHTLINER	FL60	Cummins ISC Diesel	1999 - 2004	THOMAS BUILT	Saf-T-Liner MVP ER	Cummins ISB Diesel	1999 - 2000
FREIGHTLINER	FL70	Cummins B Series 5.9 L Diesel	1997 - 1997	THOMAS BUILT	Saf-T-Liner MVP ER	Cummins ISC Diesel	2000 - 2000
FREIGHTLINER	FL70	Cummins ISB Diesel	1998 - 2003				
FREIGHTLINER	FL70	Cummins ISC Diesel	1999 - 2005				
FREIGHTLINER	FL80	Cummins B Series 5.9 L Diesel	1997 - 1997				
FREIGHTLINER	FL80	Cummins ISB Diesel	1998 - 2003				
FREIGHTLINER	FL80	Cummins ISC Diesel	1999 - 2004				
FREIGHTLINER	FLD	Caterpillar C11 Diesel	2004 - 2007				
FREIGHTLINER	FLD	Caterpillar C13 Diesel	2004 - 2007				
FREIGHTLINER	FLD	Caterpillar C15 Diesel	2004 - 2008				
INTERNATIONAL/NAVIS	5500i	Caterpillar C13 Diesel	2005 - 2007				
INTERNATIONAL/NAVIS	5600i	Caterpillar C13 Diesel	2005 - 2007				
INTERNATIONAL/NAVIS	5900i	Caterpillar C13 Diesel	2005 - 2007				
INTERNATIONAL/NAVIS	7600	Caterpillar C13 Diesel	2004 - 2008				
INTERNATIONAL/NAVIS	7700	Caterpillar C13 Diesel	2005 - 2007				
INTERNATIONAL/NAVIS	8600	Caterpillar C13 Diesel	2004 - 2007				
INTERNATIONAL/NAVIS	9200i	Caterpillar C13 Diesel	2004 - 2007				
INTERNATIONAL/NAVIS	9400i	Caterpillar C13 Diesel	2004 - 2007				
INTERNATIONAL/NAVIS	9400i	Caterpillar C15 Diesel	2004 - 2007				
INTERNATIONAL/NAVIS	9900i	Caterpillar C13 Diesel	2004 - 2007				
INTERNATIONAL/NAVIS	9900i	Caterpillar C15 Diesel	2004 - 2007				
INTERNATIONAL/NAVIS	9900ix	Caterpillar C15 Diesel	2008 - 2008				
INTERNATIONAL/NAVIS	PayStar 5600i	Caterpillar C13 Diesel	2008 - 2008				
INTERNATIONAL/NAVIS	TranStar 8500	Caterpillar C13 Diesel	2008 - 2008				
INTERNATIONAL/NAVIS	TranStar 8600	Caterpillar C13 Diesel	2008 - 2008				
INTERNATIONAL/NAVIS	WorkStar 7700	Caterpillar C13 Diesel	2008 - 2008				
KENWORTH	T2000	Caterpillar C15 Diesel	2004 - 2007				
KENWORTH	T300	Cummins ISC Diesel	2001 - 2004				
KENWORTH	T600	Caterpillar C15 Diesel	2000 - 2007				
KENWORTH	T660	Caterpillar C15 Diesel	2007 - 2007				
KENWORTH	T800	Caterpillar C11 Diesel	2003 - 2008				
KENWORTH	T800	Caterpillar C13 Diesel	2004 - 2007				
KENWORTH	T800	Caterpillar C15 Diesel	2004 - 2007				
KENWORTH	T800	CUMMINS ISL	2006 - 2006				

**36095**



FORD	F600	Cummins B Series 5.9 L Diesel	1992 - 1994				
FREIGHTLINER	Argosy	Cummins ISX Diesel	1999 - 2003				
FREIGHTLINER	Century Class	Cummins ISX Diesel	2000 - 2001				
FREIGHTLINER	Columbia	Cummins ISX Diesel	2001 - 2001				
FREIGHTLINER	FC70	Cummins ISB Diesel	2003 - 2003				
FREIGHTLINER	FC80	Cummins ISB Diesel	2003 - 2003				
FREIGHTLINER	FLD	Cummins ISX Diesel	1999 - 2003				
INTERNATIONAL/NAVIS	9100i	Cummins ISX Diesel	2001 - 2003				
INTERNATIONAL/NAVIS	9200i	Cummins Signature 600 Diesel	2000 - 2002				
INTERNATIONAL/NAVIS	9400i	Cummins ISX Diesel	2000 - 2002				
INTERNATIONAL/NAVIS	9900i	Cummins ISX Diesel	2000 - 2003				
INTERNATIONAL/NAVIS	9900ix	Cummins ISX Diesel	2000 - 2003				
KENWORTH	T2000	Cummins ISX Diesel	1999 - 2003				
KENWORTH	T600	Cummins ISX Diesel	2002 - 2003				
KENWORTH	T600	Cummins Signature 600 Diesel	2003 - 2003				
KENWORTH	T800	Cummins ISX Diesel	1999 - 2003				
KENWORTH	W900	Cummins ISX Diesel	1999 - 2003				
KENWORTH	W900	Cummins Signature 600 Diesel	2000 - 2002				
MACK	CH Series	Cummins Signature 600 Diesel	2001 - 2003				
MACK	CL Series	Cummins Signature 600 Diesel	2001 - 2003				
PETERBILT	378	Cummins ISX Diesel	2000 - 2002				
PETERBILT	378	Cummins Signature 600 Diesel	2000 - 2002				
PETERBILT	379	Cummins ISX Diesel	1998 - 2002				
PETERBILT	379	Cummins Signature 600 Diesel	2000 - 2002				
PETERBILT	387	Cummins ISX Diesel	2001 - 2002				
PETERBILT	387	Cummins Signature 600 Diesel	2001 - 2002				
STERLING	L-Line	Cummins ISX Diesel	2001 - 2001				
STERLING	L-LINE	CUMMINS SIGNATURE 600	2001 - 2001				
STERLING	L-Line	Cummins Signature 600 Diesel	2001 - 2001				



VOLVO	VN Series	Cummins ISX Diesel	2000 - 2003
VOLVO	VN Series	Cummins Signature 600 Diesel	2003 - 2003

**36096**



CHEVROLET	C5500	Caterpillar 3126 Diesel	1998 - 2002
CHEVROLET	C6500	Caterpillar 3126 Diesel	1998 - 2003
CHEVROLET	C6500	Caterpillar C7 Diesel	2004 - 2007
CHEVROLET	C7500	Caterpillar 3126 Diesel	1998 - 2003
CHEVROLET	C7500	Caterpillar C7 Diesel	2004 - 2007
CHEVROLET	C8500	Caterpillar 3126 Diesel	1998 - 2003
CHEVROLET	C8500	Caterpillar C7 Diesel	2004 - 2007
CHEVROLET	KODIAK	CATERPILLAR 3116 DIESEL	1997 - 2000
CHEVROLET	KODIAK	CATERPILLAR 3126 DIESEL	2000 - 2008
FREIGHTLINER	Business Class M2	Caterpillar 3126 Diesel	2007 - 2007
FREIGHTLINER	Business Class M2	Caterpillar C7 Diesel	2007 - 2007
FREIGHTLINER	FL50	Caterpillar 3126 Diesel	1995 - 2004
FREIGHTLINER	FL60	Caterpillar 3126 Diesel	1995 - 2004
FREIGHTLINER	FL70	Caterpillar 3126 Diesel	1995 - 2004
FREIGHTLINER	FL80	Caterpillar 3126 Diesel	1995 - 2005
KENWORTH	T300	Caterpillar C7 Diesel	2004 - 2007
PETERBILT	320	Caterpillar C7 Diesel	2004 - 2007
PETERBILT	330	Caterpillar C7 Diesel	2004 - 2007
PETERBILT	335	Caterpillar C7 Diesel	2005 - 2007
STERLING	Acterra	Caterpillar 3126 Diesel	2001 - 2004
STERLING	Acterra	Caterpillar C7 Diesel	2004 - 2007

**36098**



VOLVO	VN Series	Cummins N14 Diesel	2000 - 2003
-------	-----------	--------------------	-------------

**36157**



FORD	E450 Super Duty	Ford V-10 6.8 L	2006 - 2007
FORD	F450 Super Duty	Ford V-10 6.8 L	2002 - 2006
FORD	F550 Super Duty	Ford V-10 6.8 L	2002 - 2006

**38001**



BLUEBIRD	Mini Bird	GM V-8 5.7 L	1998 - 1998
CHEVROLET	C4500	GM V-8 8.1 L	2003 - 2008
CHEVROLET	C5500	GM V-8 8.1 L	2003 - 2008
CHEVROLET	W3500	GM V-8 6.0 L	2006 - 2006
FORD	E450 Super Duty	Ford V-10 6.8 L	2002 - 2007

FORD	E550 Super Duty	Ford V-10 6.8 L	2002 - 2003
FORD	F450 Super Duty	Ford V-10 6.8 L	2002 - 2006
FORD	F550 Super Duty	Ford V-10 6.8 L	2002 - 2006
THOMAS BUILT	Minotour	GM V-8 4.8 L	2004 - 2004
THOMAS BUILT	Minotour	GM V-8 6.0 L	2005 - 2006

**38006**



CHEVROLET	C4500	GM V-8 8.1 L	2003 - 2008
CHEVROLET	C5500	GM V-8 8.1 L	2001 - 2008
CHEVROLET	C6500	GM V-8 8.1 L	2001 - 2008
CHEVROLET	C7500	GM V-8 8.1 L	2001 - 2008
CHEVROLET	C8500	GM V-8 8.1 L	2001 - 2008
FORD	E450 Super Duty	Ford V-10 6.8 L	2007 - 2007

**38008**



BLUEBIRD	Mini Bird	GM V-8 5.7 L	1998 - 1998
CHEVROLET	C4500	GM V-8 6.6 L Diesel	2003 - 2008
CHEVROLET	C4500	GM V-8 8.1 L	2003 - 2007
CHEVROLET	C5500	GM V-8 6.6 L Diesel	2003 - 2008
CHEVROLET	C5500	GM V-8 8.1 L	2003 - 2007
THOMAS BUILT	Minotour	GM V-8 5.7 L	2001 - 2001

**38009**



CHEVROLET	W3500	GM V-8 6.0 L	2006 - 2007
CHEVROLET	W4500	GM V-8 6.0 L	2006 - 2007
THOMAS BUILT	Minotour	GM V-8 4.8 L	2004 - 2004
THOMAS BUILT	Minotour	GM V-8 6.0 L	2005 - 2006

**38015**



FORD	F Super Duty	Ford V-8 7.3 L Diesel	1992 - 1994
------	--------------	-----------------------	-------------



### 38022



FORD	E450 Super Duty	Ford V-10 6.8 L	1999 - 2001
FORD	E450 Super Duty	Ford V-8 5.4 L	2000 - 2001
FORD	F Super Duty	Ford V-8 7.3 L Diesel	1995 - 1998
FORD	F450 Super Duty	Ford V-10 6.8 L	1999 - 2001
FORD	F550 Super Duty	Ford V-10 6.8 L	1999 - 2001

FORD	E550 Super Duty	Ford V-8 7.3 L Diesel	2002 - 2003
FORD	F450 Super Duty	Ford V-8 7.3 L Diesel	1999 - 2003
FORD	F550 Super Duty	Ford V-8 7.3 L Diesel	1999 - 2004
FORD	F650 Super Duty	Ford V-8 7.3 L Diesel	2000 - 2004
FORD	F750 Super Duty	Ford V-8 7.3 L Diesel	2000 - 2004

### 38075



### 38023

FORD	E450 Super Duty	Ford V-10 6.8 L	1999 - 2005
FORD	E450 Super Duty	Ford V-8 5.4 L	2000 - 2001
FORD	E550 Super Duty	Ford V-10 6.8 L	2002 - 2003
FORD	F450 Super Duty	Ford V-10 6.8 L	1999 - 2001
FORD	F550 Super Duty	Ford V-10 6.8 L	1999 - 2001

FREIGHTLINER	Argosy	Detroit Diesel 6-Cyl. 11.1 L Diesel	1999 - 2003
FREIGHTLINER	Argosy	Detroit Diesel 6-Cyl. 12.7 L Diesel	1999 - 2006
FREIGHTLINER	Argosy	Detroit Diesel 6-Cyl. 14.0 L Diesel	2003 - 2006
FREIGHTLINER	Business Class M2	Mercedes-Benz MBE 4000 Diesel	2004 - 2007
FREIGHTLINER	Cascadia	Detroit Diesel 6-Cyl. 14.0 L Diesel	2008 - 2008
FREIGHTLINER	Century Class	Detroit Diesel 6-Cyl. 11.1 L Diesel	1999 - 2003
FREIGHTLINER	Century Class	Detroit Diesel 6-Cyl. 12.7 L Diesel	1999 - 2007
FREIGHTLINER	Century Class	Detroit Diesel 6-Cyl. 14.0 L Diesel	2003 - 2007
FREIGHTLINER	CENTURY CLASS	DETROIT DIESEL SERIE 60	2002 - 2005
FREIGHTLINER	Century Class	Mercedes-Benz MBE 4000 Diesel	2001 - 2005
FREIGHTLINER	Classic	Detroit Diesel 6-Cyl. 11.1 L Diesel	2001 - 2002
FREIGHTLINER	Classic	Detroit Diesel 6-Cyl. 12.7 L Diesel	2001 - 2007
FREIGHTLINER	Classic	Detroit Diesel 6-Cyl. 14.0 L Diesel	2003 - 2008
FREIGHTLINER	CLASSIC	DETROIT DIESEL SERIE 60	2005 - 2005
FREIGHTLINER	Classic XL	Detroit Diesel 6-Cyl. 11.1 L Diesel	2001 - 2002
FREIGHTLINER	Classic XL	Detroit Diesel 6-Cyl. 12.7 L Diesel	2001 - 2007
FREIGHTLINER	Classic XL	Detroit Diesel 6-Cyl. 14.0 L Diesel	2001 - 2008
FREIGHTLINER	Columbia	Detroit Diesel 6-Cyl. 11.1 L Diesel	2000 - 2001
FREIGHTLINER	Columbia	Detroit Diesel 6-Cyl. 12.7 L Diesel	2000 - 2008
FREIGHTLINER	Columbia	Detroit Diesel 6-Cyl. 14.0 L Diesel	2002 - 2008
FREIGHTLINER	COLUMBIA	DETROIT DIESEL SERIE 60	2001 - 2005
FREIGHTLINER	Columbia	Mercedes-Benz MBE 4000 Diesel	2005 - 2005
FREIGHTLINER	Coronado	Detroit Diesel 6-Cyl. 12.7 L Diesel	2002 - 2008
FREIGHTLINER	Coronado	Detroit Diesel 6-Cyl. 14.0 L Diesel	2003 - 2008
FREIGHTLINER	CORONADO	DETROIT DIESEL SERIE 60	2004 - 2006
FREIGHTLINER	FLD	Detroit Diesel 6-Cyl. 11.1 L Diesel	2000 - 2002
FREIGHTLINER	FLD	Detroit Diesel 6-Cyl. 12.7 L Diesel	2000 - 2008
FREIGHTLINER	FLD	Detroit Diesel 6-Cyl. 14.0 L Diesel	2001 - 2008
FREIGHTLINER	FLD120	DETROIT DIESEL SERIE 60	1999 - 2001
FREIGHTLINER	T2000	Detroit Diesel 6-Cyl. 11.1 L Diesel	2000 - 2000
FREIGHTLINER	T2000	Detroit Diesel 6-Cyl. 12.7 L Diesel	2000 - 2000
FREIGHTLINER	T800	Detroit Diesel 6-Cyl. 11.1 L Diesel	2000 - 2001
FREIGHTLINER	T800	Detroit Diesel 6-Cyl. 12.7 L Diesel	2000 - 2001
FREIGHTLINER	T800	DETROIT DIESEL SERIE 60	2001 - 2001
FREIGHTLINER	W900	Detroit Diesel 6-Cyl. 11.1 L Diesel	2000 - 2001
FREIGHTLINER	W900	Detroit Diesel 6-Cyl. 12.7 L Diesel	2000 - 2001
FREIGHTLINER	PETERBILT	Detroit Diesel 6-Cyl. 11.1 L Diesel	2000 - 2001
FREIGHTLINER	PETERBILT	Detroit Diesel 6-Cyl. 12.7 L Diesel	2000 - 2001
FREIGHTLINER	STERLING	Detroit Diesel 6-Cyl. 11.1 L Diesel	2000 - 2001
FREIGHTLINER	STERLING	Detroit Diesel 6-Cyl. 12.7 L Diesel	2000 - 2006
FREIGHTLINER	STERLING	Detroit Diesel 6-Cyl. 14.0 L Diesel	2004 - 2006
FREIGHTLINER	STERLING	DETROIT DIESEL SERIE 60	2001 - 2006
FREIGHTLINER	STERLING	Mercedes-Benz MBE 4000 Diesel	2004 - 2006
FREIGHTLINER	STERLING	Detroit Diesel 6-Cyl. 11.1 L Diesel	2000 - 2001
FREIGHTLINER	STERLING	Detroit Diesel 6-Cyl. 12.7 L Diesel	2000 - 2008
FREIGHTLINER	STERLING	Detroit Diesel 6-Cyl. 14.0 L Diesel	2003 - 2008
FREIGHTLINER	STERLING	DETROIT DIESEL SERIE 60	2001 - 2006
FREIGHTLINER	STERLING	Mercedes-Benz MBE 4000 Diesel	2003 - 2007

### 38028



FORD	E450 Super Duty	Ford V-8 7.3 L Diesel	1998 - 2003
FORD	E550 Super Duty	Ford V-8 7.3 L Diesel	2002 - 2003
FORD	F450 Super Duty	Ford V-8 7.3 L Diesel	1999 - 2003
FORD	F550 Super Duty	Ford V-8 7.3 L Diesel	1999 - 2004
FORD	F650 Super Duty	Ford V-8 7.3 L Diesel	2000 - 2004
FORD	F750 Super Duty	Ford V-8 7.3 L Diesel	2000 - 2004

### 38033



CHEVROLET	C5500	GM V-8 8.1 L	2001 - 2002
CHEVROLET	C6500	GM V-8 8.1 L	2001 - 2008
CHEVROLET	C7500	GM V-8 8.1 L	2001 - 2008
CHEVROLET	C8500	GM V-8 8.1 L	2001 - 2008

### 38053



FORD	E450 Super Duty	Ford V-8 7.3 L Diesel	1998 - 2003
------	-----------------	-----------------------	-------------



### 38076

FREIGHTLINER	Argosy	Detroit Diesel 6-Cyl. 11.1 L Diesel	2000 - 2003
FREIGHTLINER	Argosy	Detroit Diesel 6-Cyl. 12.7 L Diesel	2000 - 2006



FREIGHTLINER	Argosy	Detroit Diesel 6-Cyl. 14.0 L Diesel	2003 - 2006
FREIGHTLINER	Cascadia	Detroit Diesel 6-Cyl. 14.0 L Diesel	2008 - 2008
FREIGHTLINER	Century Class	Detroit Diesel 6-Cyl. 12.7 L Diesel	2004 - 2007
FREIGHTLINER	Century Class	Detroit Diesel 6-Cyl. 14.0 L Diesel	2004 - 2007
FREIGHTLINER	CENTURY CLASS	DETROIT DIESEL SERIE 60	2005 - 2005
FREIGHTLINER	Classic	Detroit Diesel 6-Cyl. 12.7 L Diesel	2005 - 2007
FREIGHTLINER	Classic	Detroit Diesel 6-Cyl. 14.0 L Diesel	2005 - 2008
FREIGHTLINER	CLASSIC	DETROIT DIESEL SERIE 60	2005 - 2005
FREIGHTLINER	Classic XL	Detroit Diesel 6-Cyl. 12.7 L Diesel	2005 - 2007
FREIGHTLINER	Classic XL	Detroit Diesel 6-Cyl. 14.0 L Diesel	2005 - 2008
FREIGHTLINER	Columbia	Detroit Diesel 6-Cyl. 12.7 L Diesel	2004 - 2008
FREIGHTLINER	Columbia	Detroit Diesel 6-Cyl. 14.0 L Diesel	2004 - 2008
FREIGHTLINER	COLUMBIA	DETROIT DIESEL SERIE 60	2006 - 2005
FREIGHTLINER	Coronado	Detroit Diesel 6-Cyl. 12.7 L Diesel	2002 - 2008
FREIGHTLINER	Coronado	Detroit Diesel 6-Cyl. 14.0 L Diesel	2003 - 2008
FREIGHTLINER	CORONADO	DETROIT DIESEL SERIE 60	2005 - 2006
FREIGHTLINER	FLD	Detroit Diesel 6-Cyl. 12.7 L Diesel	2005 - 2008
FREIGHTLINER	FLD	Detroit Diesel 6-Cyl. 14.0 L Diesel	2005 - 2008
STERLING	A-Line	Detroit Diesel 6-Cyl. 12.7 L Diesel	2004 - 2006
STERLING	A-Line	Detroit Diesel 6-Cyl. 14.0 L Diesel	2004 - 2006
STERLING	A-LINE	DETROIT DIESEL SERIE 60	2004 - 2006
STERLING	L-Line	Detroit Diesel 6-Cyl. 12.7 L Diesel	2004 - 2008
STERLING	L-Line	Detroit Diesel 6-Cyl. 14.0 L Diesel	2004 - 2008
STERLING	L-LINE	DETROIT DIESEL SERIE 60	2004 - 2006
VOLVO	VNL 64T 420	DETROIT DIESEL SERIE 60	2001 - 2001
VOLVO	VNL 64T 420 6X4 TIPICO	DETROIT DIESEL SERIE 60	1999 - 2000
VOLVO	VNL 64T 420 STANDAR	DETROIT DIESEL SERIE 60	1999 - 2000
VOLVO	VNL 64T 610	DETROIT DIESEL SERIE 60	1999 - 2000

**38092**



FREIGHTLINER	Century Class	Caterpillar C10 Diesel	1999 - 2000
FREIGHTLINER	Century Class	Caterpillar C12 Diesel	1999 - 2000
FREIGHTLINER	FL112	Caterpillar C10 Diesel	1999 - 2000
FREIGHTLINER	FL112	Caterpillar C12 Diesel	1999 - 2000
FREIGHTLINER	FLD	Caterpillar C10 Diesel	1998 - 2000
FREIGHTLINER	FLD	Caterpillar C12 Diesel	1998 - 2000

**38103**



BLUEBIRD	Mini Bird	GM V-8 5.7 L	1998 - 1998
THOMAS BUILT	Minotour	GM V-8 5.7 L	2001 - 2001

**38133**



FORD	E450 Super Duty	Ford V-10 6.8 L	1999 - 2005
FORD	E450 Super Duty	Ford V-8 5.4 L	2000 - 2001
FORD	E550 Super Duty	Ford V-10 6.8 L	2002 - 2003
FORD	F450 Super Duty	Ford V-10 6.8 L	1999 - 2001
FORD	F550 Super Duty	Ford V-10 6.8 L	1999 - 2001

<b>38158</b>			
			
CHEVROLET	W3500	GM V-8 6.0 L	2006 - 2007
CHEVROLET	W4500	GM V-8 6.0 L	2006 - 2007
THOMAS BUILT	Minotour	GM V-8 4.8 L	2004 - 2005
THOMAS BUILT	Minotour	GM V-8 6.0 L	2005 - 2006

**38159**



CHEVROLET	W3500	GM V-8 6.0 L	2006 - 2007
CHEVROLET	W4500	GM V-8 6.0 L	2006 - 2007
THOMAS BUILT	Minotour	GM V-8 4.8 L	2004 - 2005
THOMAS BUILT	Minotour	GM V-8 6.0 L	2005 - 2006

**38172**



CHEVROLET	C4500	GM V-8 6.6 L Diesel	2003 - 2008
CHEVROLET	C5500	GM V-8 6.6 L Diesel	2003 - 2008

**38191**



FORD	F450 Super Duty	Ford V-8 7.3 L Diesel	1999 - 2003
FORD	F550 Super Duty	Ford V-8 7.3 L Diesel	1999 - 2004
FORD	F650 Super Duty	Ford V-8 7.3 L Diesel	2000 - 2004
FORD	F750 Super Duty	Ford V-8 7.3 L Diesel	2000 - 2004

**38256**



CHEVROLET	C5500	GM V-8 8.1 L	2001 - 2002
CHEVROLET	C6500	GM V-8 8.1 L	2001 - 2008
CHEVROLET	C7500	GM V-8 8.1 L	2001 - 2008
CHEVROLET	C8500	GM V-8 8.1 L	2001 - 2008
CHEVROLET	KODIAK	GM V-8, 8.1 L	2001 - 2008





**38257**



FORD	E450 Super Duty	Ford V-8 6.0 L Diesel	2003 - 2006
FORD	F450 Super Duty	Ford V-8 6.0 L Diesel	2003 - 2007
FORD	F550 Super Duty	Ford V-8 6.0 L Diesel	2003 - 2007

**38329**



FORD	E450 Super Duty	Ford V-10 6.8 L	2006 - 2007
FORD	E450 Super Duty	Ford V-8 5.4 L	2005 - 2005
FORD	F450 Super Duty	Ford V-10 6.8 L	2002 - 2006
FORD	F550 Super Duty	Ford V-10 6.8 L	2002 - 2006

**38258**



CHEVROLET	C4500	GM V-8 8.1 L	2003 - 2008
CHEVROLET	C5500	GM V-8 8.1 L	2003 - 2008

**38330**



FORD	E450 Super Duty	Ford V-10 6.8 L	1999 - 2005
FORD	E550 Super Duty	Ford V-10 6.8 L	2002 - 2003
FORD	F450 Super Duty	Ford V-10 6.8 L	1999 - 2001
FORD	F550 Super Duty	Ford V-10 6.8 L	1999 - 2001

**38261**



CHEVROLET	C5500	GM V-8 8.1 L	2001 - 2002
CHEVROLET	C6500	GM V-8 8.1 L	2001 - 2002
CHEVROLET	C7500	GM V-8 8.1 L	2001 - 2002
CHEVROLET	C8500	GM V-8 8.1 L	2001 - 2002
CHEVROLET	KODIAK	GM V-8, 8.1 L	2001 - 2008

**38501**



FREIGHTLINER	Argosy	Detroit Diesel 6-Cyl. 11.1 L Diesel	1999 - 2003
FREIGHTLINER	Argosy	Detroit Diesel 6-Cyl. 12.7 L Diesel	1999 - 2006
FREIGHTLINER	Argosy	Detroit Diesel 6-Cyl. 14.0 L Diesel	2003 - 2006
FREIGHTLINER	Business Class M2	Mercedes-Benz MBE 4000 Diesel	2004 - 2007
FREIGHTLINER	Cascadia	Detroit Diesel 6-Cyl. 14.0 L Diesel	2008 - 2008
FREIGHTLINER	Century Class	Detroit Diesel 6-Cyl. 11.1 L Diesel	1999 - 2003
FREIGHTLINER	Century Class	Detroit Diesel 6-Cyl. 12.7 L Diesel	1999 - 2007
FREIGHTLINER	Century Class	Detroit Diesel 6-Cyl. 14.0 L Diesel	2003 - 2007
FREIGHTLINER	CENTURY CLASS	DETROIT DIESEL SERIE 60	2002 - 2005
FREIGHTLINER	Century Class	Mercedes-Benz MBE 4000 Diesel	2001 - 2005
FREIGHTLINER	Classic	Detroit Diesel 6-Cyl. 11.1 L Diesel	2001 - 2002
FREIGHTLINER	Classic	Detroit Diesel 6-Cyl. 12.7 L Diesel	2001 - 2007
FREIGHTLINER	Classic	Detroit Diesel 6-Cyl. 14.0 L Diesel	2003 - 2008
FREIGHTLINER	CLASSIC	DETROIT DIESEL SERIE 60	2005 - 2005
FREIGHTLINER	Classic XL	Detroit Diesel 6-Cyl. 11.1 L Diesel	2001 - 2002
FREIGHTLINER	Classic XL	Detroit Diesel 6-Cyl. 12.7 L Diesel	2001 - 2007
FREIGHTLINER	Classic XL	Detroit Diesel 6-Cyl. 14.0 L Diesel	2001 - 2008
FREIGHTLINER	Columbia	Detroit Diesel 6-Cyl. 11.1 L Diesel	2000 - 2001
FREIGHTLINER	Columbia	Detroit Diesel 6-Cyl. 12.7 L Diesel	2000 - 2008
FREIGHTLINER	Columbia	Detroit Diesel 6-Cyl. 14.0 L Diesel	2002 - 2008
FREIGHTLINER	COLUMBIA	DETROIT DIESEL SERIE 60	2001 - 2005
FREIGHTLINER	Columbia	Mercedes-Benz MBE 4000 Diesel	2005 - 2007
FREIGHTLINER	Coronado	Detroit Diesel 6-Cyl. 12.7 L Diesel	2002 - 2008
FREIGHTLINER	Coronado	Detroit Diesel 6-Cyl. 14.0 L Diesel	2003 - 2008
FREIGHTLINER	CORONADO	DETROIT DIESEL SERIE 60	2004 - 2006
FREIGHTLINER	FLD	Detroit Diesel 6-Cyl. 11.1 L Diesel	2000 - 2002
FREIGHTLINER	FLD	Detroit Diesel 6-Cyl. 12.7 L Diesel	2000 - 2008
FREIGHTLINER	FLD	Detroit Diesel 6-Cyl. 14.0 L Diesel	2001 - 2008
FREIGHTLINER	FLD	DETROIT DIESEL SERIE 60	2002 - 2006
FREIGHTLINER	FLD120	DETROIT DIESEL SERIE 60	1999 - 2001
KENWORTH	T2000	Detroit Diesel 6-Cyl. 11.1 L Diesel	2000 - 2000
KENWORTH	T2000	Detroit Diesel 6-Cyl. 12.7 L Diesel	2000 - 2000
KENWORTH	T800	Detroit Diesel 6-Cyl. 11.1 L Diesel	2000 - 2001
KENWORTH	T800	Detroit Diesel 6-Cyl. 12.7 L Diesel	2000 - 2001
KENWORTH	T800	DETROIT DIESEL SERIE 60	2001 - 2001
KENWORTH	W900	Detroit Diesel 6-Cyl. 11.1 L Diesel	2000 - 2001

**38274**

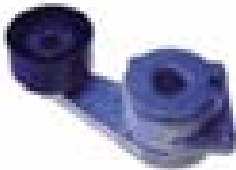

FORD	E450 Super Duty	Ford V-10 6.8 L	2006 - 2007
FORD	E450 Super Duty	Ford V-8 5.4 L	2002 - 2004
FORD	F450 Super Duty	Ford V-10 6.8 L	2002 - 2006
FORD	F550 Super Duty	Ford V-10 6.8 L	2002 - 2006

**38324**



CHEVROLET	C6500	GM V-8 8.1 L	2003 - 2008
CHEVROLET	C7500	GM V-8 8.1 L	2003 - 2008
CHEVROLET	C8500	GM V-8 8.1 L	2003 - 2008



# Catálogo de Poleas, Tensores y Kits 2009

KENWORTH	W900	Detroit Diesel 6-Cyl. 12.7 L Diesel	2000 - 2001
PETERBILT	379	Detroit Diesel 6-Cyl. 11.1 L Diesel	2000 - 2001
PETERBILT	379	Detroit Diesel 6-Cyl. 12.7 L Diesel	2000 - 2001
STERLING	A-Line	Detroit Diesel 6-Cyl. 11.1 L Diesel	2001 - 2002
STERLING	A-Line	Detroit Diesel 6-Cyl. 12.7 L Diesel	2001 - 2006
STERLING	A-Line	Detroit Diesel 6-Cyl. 14.0 L Diesel	2004 - 2006
STERLING	A-LINE	DETROIT DIESEL SERIE 60	2002 - 2006
STERLING	A-Line	Mercedes-Benz MBE 4000 Diesel	2004 - 2008
STERLING	L-Line	Detroit Diesel 6-Cyl. 11.1 L Diesel	2002 - 2002
STERLING	L-Line	Detroit Diesel 6-Cyl. 12.7 L Diesel	2002 - 2008
STERLING	L-Line	Detroit Diesel 6-Cyl. 14.0 L Diesel	2004 - 2008
STERLING	L-LINE	DETROIT DIESEL SERIE 60	2002 - 2006
STERLING	L-Line	Mercedes-Benz MBE 4000 Diesel	2003 - 2007

## 38504



FREIGHTLINER FL80 Cummins C Series 8.3 L Diesel 1997 - 1997

## 38502



STERLING	A-Line	Detroit Diesel 6-Cyl. 11.1 L Diesel	2000 - 2000
STERLING	A-Line	Detroit Diesel 6-Cyl. 12.7 L Diesel	2000 - 2000
STERLING	A-LINE	DETROIT DIESEL SERIE 60	2001 - 2001
STERLING	L-Line	Detroit Diesel 6-Cyl. 11.1 L Diesel	2000 - 2001
STERLING	L-Line	Detroit Diesel 6-Cyl. 12.7 L Diesel	2000 - 2003
STERLING	L-Line	Detroit Diesel 6-Cyl. 14.0 L Diesel	2003 - 2003
STERLING	L-LINE	DETROIT DIESEL SERIE 60	2001 - 2003

## 38505



STERLING	A-Line	Detroit Diesel 6-Cyl. 11.1 L Diesel	2000 - 2000	FREIGHTLINER	Century Class	Caterpillar C12 Diesel	1998 - 1998
STERLING	A-Line	Detroit Diesel 6-Cyl. 12.7 L Diesel	2000 - 2000	FREIGHTLINER	Century Class	Cummins ISM Diesel	1999 - 2001
STERLING	A-LINE	DETROIT DIESEL SERIE 60	2001 - 2001	FREIGHTLINER	Classic	Cummins ISM Diesel	2001 - 2003
STERLING	L-Line	Detroit Diesel 6-Cyl. 11.1 L Diesel	2000 - 2001	FREIGHTLINER	Classic XL	Cummins ISM Diesel	2001 - 2003
STERLING	L-Line	Detroit Diesel 6-Cyl. 12.7 L Diesel	2000 - 2003	FREIGHTLINER	Columbia	Cummins ISM Diesel	2001 - 2003
STERLING	L-Line	Detroit Diesel 6-Cyl. 14.0 L Diesel	2003 - 2003	FREIGHTLINER	Condor	Cummins ISM Diesel	2001 - 2002
STERLING	L-LINE	DETROIT DIESEL SERIE 60	2001 - 2003	FREIGHTLINER	FL112	Cummins ISM Diesel	1999 - 2003
				FREIGHTLINER	FL112	DETROIT DIESEL SERIE 50	1999 - 1999
				FREIGHTLINER	FLD	Cummins ISM Diesel	1999 - 2003
				INTERNATIONAL/NAVIS	5500	CUMMINS ISM DIESEL	2005 - 2005
				INTERNATIONAL/NAVIS	5500i	Cummins ISM Diesel	2002 - 2006
				INTERNATIONAL/NAVIS	5600	CUMMINS ISM DIESEL	2005 - 2005
				INTERNATIONAL/NAVIS	5600i	Cummins ISM Diesel	2002 - 2007
				INTERNATIONAL/NAVIS	5900i	Cummins ISM Diesel	2001 - 2006
				INTERNATIONAL/NAVIS	7400	Cummins ISM Diesel	2005 - 2005
				INTERNATIONAL/NAVIS	7600	Cummins ISM Diesel	2003 - 2007
				INTERNATIONAL/NAVIS	7700	Cummins ISM Diesel	2005 - 2006
				INTERNATIONAL/NAVIS	8600	Cummins ISM Diesel	2003 - 2007
				INTERNATIONAL/NAVIS	9200	CUMMINS ISM DIESEL	2005 - 2005
				INTERNATIONAL/NAVIS	9200i	Cummins ISM Diesel	2003 - 2007
				INTERNATIONAL/NAVIS	9400i	Cummins ISM Diesel	2004 - 2007
				INTERNATIONAL/NAVIS	TranStar 8600	Cummins ISM Diesel	2008 - 2008
				INTERNATIONAL/NAVIS	WorkStar 7600	Cummins ISM Diesel	2008 - 2008
FREIGHTLINER	Argosy	Detroit Diesel 6-Cyl. 11.1 L Diesel	2000 - 2003	KENWORTH	T2000	Caterpillar C10 Diesel	1997 - 1999
FREIGHTLINER	Argosy	Detroit Diesel 6-Cyl. 12.7 L Diesel	2000 - 2006	KENWORTH	T2000	Caterpillar C12 Diesel	1998 - 1999
FREIGHTLINER	Argosy	Detroit Diesel 6-Cyl. 14.0 L Diesel	2003 - 2006	KENWORTH	T600	Cummins ISM Diesel	2004 - 2004
FREIGHTLINER	Cascadia	Detroit Diesel 6-Cyl. 14.0 L Diesel	2008 - 2008	KENWORTH	T800	Cummins ISM Diesel	2003 - 2006
FREIGHTLINER	Century Class	Detroit Diesel 6-Cyl. 12.7 L Diesel	2004 - 2007	KENWORTH	T800B AEROCAB	CATERPILLAR C10 DIESEL	1999 - 2000
FREIGHTLINER	Century Class	Detroit Diesel 6-Cyl. 14.0 L Diesel	2004 - 2007	KENWORTH	T800B AEROCAB	CATERPILLAR C12 DIESEL	1999 - 2000
FREIGHTLINER	CENTURY CLASS	DETROIT DIESEL SERIE 60	2005 - 2005	KENWORTH	T800SH AEROCAB	CATERPILLAR C10 DIESEL	1999 - 2000
FREIGHTLINER	Classic	Detroit Diesel 6-Cyl. 12.7 L Diesel	2005 - 2007	KENWORTH	T800SH AEROCAB	CATERPILLAR C12 DIESEL	1999 - 2000
FREIGHTLINER	Classic	Detroit Diesel 6-Cyl. 14.0 L Diesel	2005 - 2008	KENWORTH	W900	Cummins ISM Diesel	2003 - 2006
FREIGHTLINER	CLASSIC	DETROIT DIESEL SERIE 60	2005 - 2005	KENWORTH	320	Cummins ISM Diesel	2007 - 2007
FREIGHTLINER	Classic XL	Detroit Diesel 6-Cyl. 12.7 L Diesel	2005 - 2007	PETERBILT	357	Cummins ISM Diesel	2001 - 2007
FREIGHTLINER	Classic XL	Detroit Diesel 6-Cyl. 14.0 L Diesel	2005 - 2008	PETERBILT	365	Cummins ISM Diesel	2007 - 2007
FREIGHTLINER	Columbia	Detroit Diesel 6-Cyl. 12.7 L Diesel	2004 - 2008	PETERBILT	378	Cummins ISM Diesel	2001 - 2007
FREIGHTLINER	Columbia	Detroit Diesel 6-Cyl. 14.0 L Diesel	2004 - 2008	PETERBILT	385	Cummins ISM Diesel	2002 - 2005
FREIGHTLINER	COLUMBIA	DETROIT DIESEL SERIE 60	2006 - 2005	PETERBILT	387	Cummins ISM Diesel	2000 - 2000
FREIGHTLINER	Coronado	Detroit Diesel 6-Cyl. 12.7 L Diesel	2002 - 2008	VOLVO	Autocar	Detroit Diesel 6-Cyl. 11.1 L Diesel	1998 - 1998
FREIGHTLINER	Coronado	Detroit Diesel 6-Cyl. 14.0 L Diesel	2003 - 2008	VOLVO	Autocar	Detroit Diesel 6-Cyl. 12.7 L Diesel	1998 - 1998
FREIGHTLINER	CORONADO	DETROIT DIESEL SERIE 60	2004 - 2006	VOLVO	VN Series	Caterpillar 3406 Diesel	1999 - 1999
FREIGHTLINER	FLD	Detroit Diesel 6-Cyl. 12.7 L Diesel	2005 - 2008	VOLVO	VN Series	Detroit Diesel 6-Cyl. 11.1 L Diesel	1998 - 2001
FREIGHTLINER	FLD	Detroit Diesel 6-Cyl. 14.0 L Diesel	2005 - 2008	VOLVO	VN Series	Detroit Diesel 6-Cyl. 12.7 L Diesel	1998 - 2001
FREIGHTLINER	FLD	DETROIT DIESEL SERIE 60	2006 - 2006	VOLVO	VN Series	DETROIT DIESEL SERIE 60	2001 - 2001
STERLING	A-Line	Detroit Diesel 6-Cyl. 12.7 L Diesel	2004 - 2006	VOLVO	VNL 64T 420	DETROIT DIESEL SERIE 60	1999 - 2000
STERLING	A-Line	Detroit Diesel 6-Cyl. 14.0 L Diesel	2004 - 2006	VOLVO	VNL 64T 420 6X4 TIPICO	DETROIT DIESEL SERIE 60	1999 - 2000
STERLING	A-LINE	DETROIT DIESEL SERIE 60	2004 - 2006	VOLVO	VNL 64T 420 STANDAR	DETROIT DIESEL SERIE 60	1999 - 2000
STERLING	L-Line	Detroit Diesel 6-Cyl. 12.7 L Diesel	2004 - 2008	VOLVO	VNL 64T 610	DETROIT DIESEL SERIE 60	1999 - 2000
STERLING	L-Line	Detroit Diesel 6-Cyl. 14.0 L Diesel	2004 - 2008				
STERLING	L-LINE	DETROIT DIESEL SERIE 60	2004 - 2006				



### 38506



FORD	F650 Super Duty	Caterpillar 3126 Diesel	2000 - 2004
FORD	F750 Super Duty	Caterpillar 3126 Diesel	2000 - 2004
FREIGHTLINER	Argosy	Caterpillar C10 Diesel	2000 - 2003
FREIGHTLINER	Argosy	Caterpillar C12 Diesel	2000 - 2004
FREIGHTLINER	Argosy	Caterpillar C15 Diesel	2001 - 2004
FREIGHTLINER	Century Class	Caterpillar 3406 Diesel	1998 - 1999
FREIGHTLINER	Century Class	Caterpillar C10 Diesel	1998 - 2003
FREIGHTLINER	Century Class	Caterpillar C12 Diesel	1999 - 2004
FREIGHTLINER	Century Class	Caterpillar C15 Diesel	2001 - 2004
FREIGHTLINER	CENTURY CLASS	DETROIT DIESEL SERIE 60	2003 - 2003
FREIGHTLINER	Classic	Caterpillar C15 Diesel	2001 - 2006
FREIGHTLINER	Classic	Caterpillar C16 Diesel	2001 - 2003
FREIGHTLINER	Classic XL	Caterpillar C15 Diesel	2001 - 2006
FREIGHTLINER	Classic XL	Caterpillar C16 Diesel	2001 - 2003
FREIGHTLINER	Columbia	Caterpillar C10 Diesel	2001 - 2003
FREIGHTLINER	Columbia	Caterpillar C12 Diesel	2003 - 2004
FREIGHTLINER	Columbia	Caterpillar C15 Diesel	2001 - 2003
FREIGHTLINER	Columbia	Caterpillar C16 Diesel	2001 - 2004
FREIGHTLINER	Condor	Caterpillar C10 Diesel	2001 - 2004
FREIGHTLINER	Condor	Caterpillar C12 Diesel	2001 - 2004
FREIGHTLINER	Coronado	Caterpillar C15 Diesel	2002 - 2004
FREIGHTLINER	Coronado	Caterpillar C16 Diesel	2002 - 2003
FREIGHTLINER	FL112	Caterpillar C10 Diesel	1999 - 2004
FREIGHTLINER	FL112	Caterpillar C12 Diesel	1999 - 2004
FREIGHTLINER	FLD	Caterpillar 3406 Diesel	1998 - 2000
FREIGHTLINER	FLD	CATERPILLAR 3406 E DIESEL	1999 - 2000
FREIGHTLINER	FLD	Caterpillar C10 Diesel	1998 - 2004
FREIGHTLINER	FLD	Caterpillar C12 Diesel	1998 - 2004
FREIGHTLINER	FLD	Caterpillar C15 Diesel	2000 - 2004
FREIGHTLINER	FLD	Caterpillar C16 Diesel	2000 - 2004
FREIGHTLINER	FLD	Caterpillar C12 Diesel	1998 - 1999
INTERNATIONAL/NAVIS	5000	Caterpillar C10 Diesel	2003 - 2004
INTERNATIONAL/NAVIS	5500i	Caterpillar C12 Diesel	2003 - 2004
INTERNATIONAL/NAVIS	5500i	Caterpillar C10 Diesel	2002 - 2004
INTERNATIONAL/NAVIS	5600i	Caterpillar C12 Diesel	2003 - 2004
INTERNATIONAL/NAVIS	5600i	Caterpillar C10 Diesel	2000 - 2003
INTERNATIONAL/NAVIS	5900i	Caterpillar C12 Diesel	2002 - 2004
INTERNATIONAL/NAVIS	5900i	Caterpillar C10 Diesel	2002 - 2004
INTERNATIONAL/NAVIS	7600	Caterpillar C12 Diesel	2002 - 2004
INTERNATIONAL/NAVIS	7600	Caterpillar C10 Diesel	2002 - 2003
INTERNATIONAL/NAVIS	8100	Caterpillar C10 Diesel	2003 - 2004
INTERNATIONAL/NAVIS	8600	Caterpillar C10 Diesel	2003 - 2004
INTERNATIONAL/NAVIS	8600	Caterpillar C12 Diesel	2003 - 2004
INTERNATIONAL/NAVIS	9200	Caterpillar 3176 Diesel	1995 - 1995
INTERNATIONAL/NAVIS	9200i	Caterpillar C10 Diesel	2004 - 2004
INTERNATIONAL/NAVIS	9200i	Caterpillar C12 Diesel	2004 - 2004
INTERNATIONAL/NAVIS	9300	Caterpillar 3176 Diesel	1995 - 1995
INTERNATIONAL/NAVIS	9400	Caterpillar C10 Diesel	1997 - 2004
KENWORTH	T600	Caterpillar C12 Diesel	1996 - 2004
KENWORTH	T600	Caterpillar C15 Diesel	2000 - 2006
KENWORTH	T800	Caterpillar C10 Diesel	1997 - 2004
KENWORTH	T800	Caterpillar C12 Diesel	1996 - 2004
KENWORTH	T800	Caterpillar C15 Diesel	2004 - 2004
PETERBILT	357	Caterpillar C10 Diesel	1997 - 2004
PETERBILT	357	Caterpillar C12 Diesel	1997 - 2004
PETERBILT	362	Caterpillar C10 Diesel	1996 - 1998
PETERBILT	362	Caterpillar C12 Diesel	1996 - 1998
PETERBILT	377	Caterpillar C10 Diesel	1997 - 1998
PETERBILT	377	Caterpillar C12 Diesel	1997 - 1998
PETERBILT	378	Caterpillar C10 Diesel	2002 - 2004
PETERBILT	378	Caterpillar C12 Diesel	2002 - 2004
PETERBILT	379	Caterpillar C10 Diesel	2002 - 2004
PETERBILT	379	Caterpillar C12 Diesel	2002 - 2004
PETERBILT	385	Caterpillar C10 Diesel	1997 - 2004
PETERBILT	385	Caterpillar C12 Diesel	1996 - 2004
PETERBILT	387	Caterpillar C10 Diesel	2000 - 2002
PETERBILT	387	Caterpillar C12 Diesel	2000 - 2002

PETERBILT	387	Caterpillar C15 Diesel	2001 - 2003
PETERBILT	387	Caterpillar C16 Diesel	2001 - 2003
STERLING	A-Line	Caterpillar C10 Diesel	2002 - 2004
STERLING	A-Line	Caterpillar C12 Diesel	2002 - 2004

### 38507



BLUEBIRD	All American RE	John Deere 6-Cyl. 8.1 L CNG	1998 - 2003
BLUEBIRD	All American RE	John Deere 6-Cyl. 8.1 L Diesel	2006 - 2006
FREIGHTLINER	Century Class	Cummins ISM Diesel	1998 - 1998
INTERNATIONAL/NAVIS	7600	Caterpillar C10 Diesel	2002 - 2003
INTERNATIONAL/NAVIS	7600	Caterpillar C12 Diesel	2002 - 2003
INTERNATIONAL/NAVIS	8100	Caterpillar C10 Diesel	2002 - 2003
INTERNATIONAL/NAVIS	8600	Caterpillar C10 Diesel	2003 - 2004
INTERNATIONAL/NAVIS	8600	Caterpillar C12 Diesel	2003 - 2004
INTERNATIONAL/NAVIS	9200i	Caterpillar C10 Diesel	2004 - 2004
INTERNATIONAL/NAVIS	9200i	Caterpillar C12 Diesel	2004 - 2004
PETERBILT	320	Cummins C Series 8.3 L Diesel	1996 - 1996
PETERBILT	320	Cummins ISC Diesel	1997 - 1997
PETERBILT	330	Caterpillar 3116 Diesel	1995 - 1998
PETERBILT	330	Caterpillar 3126 Diesel	1995 - 1997
PETERBILT	357	Caterpillar 3126 Diesel	1998 - 1999
THOMAS BUILT	Saf-T-Liner MVP ER	John Deere 6-Cyl. 8.1 L CNG	2001 - 2007

### 38508



FREIGHTLINER	Argosy	Caterpillar C15 Diesel	2001 - 2004
FREIGHTLINER	Century Class	Caterpillar 3406 Diesel	1998 - 1999
FREIGHTLINER	Century Class	Caterpillar C15 Diesel	2001 - 2004
FREIGHTLINER	Classic	Caterpillar C15 Diesel	2001 - 2006
FREIGHTLINER	Classic	Caterpillar C16 Diesel	2001 - 2003
FREIGHTLINER	Classic XL	Caterpillar C15 Diesel	2001 - 2006
FREIGHTLINER	Classic XL	Caterpillar C16 Diesel	2001 - 2003
FREIGHTLINER	Columbia	Caterpillar C15 Diesel	2001 - 2003
FREIGHTLINER	Columbia	Caterpillar C16 Diesel	2001 - 2004
FREIGHTLINER	Coronado	Caterpillar C15 Diesel	2002 - 2004
FREIGHTLINER	Coronado	Caterpillar C16 Diesel	2002 - 2003
FREIGHTLINER	FL50	Caterpillar C7 Diesel	2004 - 2004
FREIGHTLINER	FL60	Caterpillar C7 Diesel	2004 - 2005
FREIGHTLINER	FL70	Caterpillar C7 Diesel	2004 - 2005
FREIGHTLINER	FL80	Caterpillar C7 Diesel	2004 - 2005
FREIGHTLINER	FLD	Caterpillar 3406 Diesel	1998 - 2000
FREIGHTLINER	FLD	CATERPILLAR 3406 E DIESEL	1999 - 2000
FREIGHTLINER	FLD	Caterpillar C15 Diesel	2000 - 2004
FREIGHTLINER	FLD	Caterpillar C16 Diesel	2000 - 2004
KENWORTH	T600	Caterpillar C15 Diesel	2000 - 2006
KENWORTH	T800	Caterpillar C15 Diesel	2004 - 2004
PETERBILT	387	Caterpillar C15 Diesel	2001 - 2003
PETERBILT	387	Caterpillar C16 Diesel	2001 - 2003

### 38509



BLUEBIRD	All American FE	Caterpillar C7 Diesel	2005 - 2006
----------	-----------------	-----------------------	-------------



# Catálogo de Poleas, Tensores y Kits 2009

BLUEBIRD	All American RE	Caterpillar 3126 Diesel	2003 - 2004
BLUEBIRD	All American RE	Caterpillar C7 Diesel	2005 - 2006
CHEVROLET	C5500	Caterpillar 3116 Diesel	1999 - 1999
CHEVROLET	C5500	Caterpillar 3126 Diesel	1998 - 2002
CHEVROLET	C6500	Caterpillar 3116 Diesel	1997 - 2000
CHEVROLET	C6500	Caterpillar 3126 Diesel	1998 - 2002
CHEVROLET	C7500	Caterpillar 3116 Diesel	1997 - 2000
CHEVROLET	C7500	Caterpillar 3126 Diesel	1998 - 2002
CHEVROLET	C8500	Caterpillar 3116 Diesel	1997 - 2000
CHEVROLET	C8500	Caterpillar 3126 Diesel	1998 - 2002
CHEVROLET	KODIAK	CATERPILLAR 3116 DIESEL	1997 - 2000
CHEVROLET	KODIAK	CATERPILLAR 3126 DIESEL	2000 - 2008
CHEVROLET	Kodiak C6500	Caterpillar 3116 Diesel	1991 - 1996
CHEVROLET	Kodiak C7500	Caterpillar 3116 Diesel	1991 - 1996
CHEVROLET	Kodiak C8500	Caterpillar 3116 Diesel	1991 - 1996

## 38510



INTERNATIONAL/NAVIS' 3800	International/Navistar T444 Diesel	1998 - 2002
INTERNATIONAL/NAVIS' 4600	International/Navistar T444 Diesel	1995 - 1995
INTERNATIONAL/NAVIS' 4700	International/Navistar T444 Diesel	1995 - 2002
INTERNATIONAL/NAVIS' 4800	International/Navistar T444 Diesel	1995 - 1997
INTERNATIONAL/NAVIS' 4900	International/Navistar T444 Diesel	1995 - 1997
INTERNATIONAL/NAVIS' CE	International/Navistar T444 Diesel	2003 - 2004
INTERNATIONAL/NAVIS' Conventional IC	International/Navistar T444 Diesel	2002 - 2003

## 38511



BLUEBIRD	TC2000	Caterpillar 3126 Diesel	1998 - 1998
FREIGHTLINER	Century Class	Caterpillar C15 Diesel	2005 - 2006
FREIGHTLINER	Classic XL	Caterpillar C15 Diesel	2005 - 2005
FREIGHTLINER	Columbia	Caterpillar C15 Diesel	2005 - 2005
FREIGHTLINER	Coronado	Caterpillar C15 Diesel	2005 - 2006
FREIGHTLINER	FL50	Caterpillar 3126 Diesel	1995 - 2004
FREIGHTLINER	FL60	Caterpillar 3126 Diesel	1995 - 2004
FREIGHTLINER	FL60	Caterpillar C7 Diesel	2004 - 2005
FREIGHTLINER	FL70	Caterpillar 3126 Diesel	1995 - 2004
FREIGHTLINER	FL70	Caterpillar C7 Diesel	2004 - 2005
FREIGHTLINER	FL80	Caterpillar 3126 Diesel	1995 - 2005
FREIGHTLINER	FL80	Caterpillar C7 Diesel	2004 - 2005
FREIGHTLINER	FLD	Caterpillar C15 Diesel	2005 - 2008
INTERNATIONAL/NAVIS' 4300	International/Navistar DT466 Diesel	2002 - 2004	
INTERNATIONAL/NAVIS' 4400	International/Navistar 530 Diesel	2002 - 2005	
INTERNATIONAL/NAVIS' 4400	International/Navistar DT466 Diesel	2002 - 2005	
INTERNATIONAL/NAVIS' 4700	International/Navistar DT408 Diesel	1995 - 1997	
INTERNATIONAL/NAVIS' 4700	International/Navistar DT466 Diesel	1995 - 1999	
INTERNATIONAL/NAVIS' 4800	International/Navistar DT408 Diesel	1995 - 1997	
INTERNATIONAL/NAVIS' 4800	International/Navistar DT466 Diesel	1995 - 2003	
INTERNATIONAL/NAVIS' 4900	International/Navistar DT408 Diesel	1995 - 1997	
INTERNATIONAL/NAVIS' 4900	International/Navistar DT466 Diesel	1995 - 1999	
INTERNATIONAL/NAVIS' 5600i	Caterpillar C15 Diesel	2004 - 2004	
INTERNATIONAL/NAVIS' 5900i	Caterpillar C15 Diesel	2004 - 2006	
INTERNATIONAL/NAVIS' 7100	International/Navistar DT466 Diesel	1995 - 1995	
INTERNATIONAL/NAVIS' 7300	International/Navistar DT466 Diesel	2002 - 2003	
INTERNATIONAL/NAVIS' 7400	International/Navistar 530 Diesel	2002 - 2003	
INTERNATIONAL/NAVIS' 7400	International/Navistar DT466 Diesel	2002 - 2003	
INTERNATIONAL/NAVIS' 7400	International/Navistar DT530 Diesel	2004 - 2005	
INTERNATIONAL/NAVIS' 7500	International/Navistar 530 Diesel	2002 - 2003	
INTERNATIONAL/NAVIS' 7500	International/Navistar DT466 Diesel	2002 - 2002	
INTERNATIONAL/NAVIS' 7500	International/Navistar DT530 Diesel	2004 - 2005	
INTERNATIONAL/NAVIS' 8100	International/Navistar 530 Diesel	1995 - 1998	

INTERNATIONAL/NAVIS' 8100	International/Navistar DT466 Diesel	1995 - 2000
INTERNATIONAL/NAVIS' 8200	Detroit Diesel 6-Cyl. 11.1 L Diesel	1995 - 1995
INTERNATIONAL/NAVIS' 8200	Detroit Diesel 6-Cyl. 12.7 L Diesel	1995 - 1995
INTERNATIONAL/NAVIS' 8200	International/Navistar 530 Diesel	1996 - 1997
INTERNATIONAL/NAVIS' 8200	International/Navistar DT466 Diesel	1997 - 1997
INTERNATIONAL/NAVIS' 8500	International/Navistar 530 Diesel	2002 - 2005
INTERNATIONAL/NAVIS' 9400i	Caterpillar C15 Diesel	2004 - 2007
INTERNATIONAL/NAVIS' 9900i	Caterpillar C15 Diesel	2004 - 2007
INTERNATIONAL/NAVIS' 9900ix	Caterpillar C15 Diesel	2004 - 2007
INTERNATIONAL/NAVIS' PayStar 5600i	Caterpillar C15 Diesel	2008 - 2008
KENWORTH T2000	Caterpillar C15 Diesel	2004 - 2007
KENWORTH T300	Caterpillar 3126 Diesel	1996 - 2003
KENWORTH T600	Caterpillar C15 Diesel	2007 - 2007
KENWORTH T800	Caterpillar C15 Diesel	2005 - 2007
KENWORTH W900	Caterpillar C15 Diesel	2004 - 2007
PETERBILT 330	Caterpillar 3126 Diesel	1998 - 2003
PETERBILT 357	Caterpillar C15 Diesel	2004 - 2007
PETERBILT 378	Caterpillar C15 Diesel	2003 - 2007
PETERBILT 379	Caterpillar C15 Diesel	2004 - 2007
PETERBILT 386	Caterpillar C15 Diesel	2006 - 2007
PETERBILT 387	Caterpillar C15 Diesel	2004 - 2007
STERLING Acterra	Caterpillar 3126 Diesel	2001 - 2003
STERLING Acterra	Caterpillar C7 Diesel	2004 - 2004
STERLING L-LINE	CATERPILLAR 3126 DIESEL	2001 - 2004
STERLING L-Line	Caterpillar C7 Diesel	2004 - 2004
THOMAS BUILT Conventional	Caterpillar 3126 Diesel	1998 - 2003
THOMAS BUILT Saf-T-Liner MVP EF	Caterpillar 3126 Diesel	1998 - 2004
THOMAS BUILT Saf-T-Liner MVP ER	Caterpillar 3126 Diesel	2001 - 2004

## 38512



INTERNATIONAL/NAVIS' 4700	International/Navistar 530 Diesel	1999 - 2002
INTERNATIONAL/NAVIS' 4700	International/Navistar DT466 Diesel	2000 - 2002
INTERNATIONAL/NAVIS' 4700 FBC	INTERNATIONAL/NAVISTAR DT466 DII	1999 - 2000
INTERNATIONAL/NAVIS' 4700 SCD	INTERNATIONAL/NAVISTAR DT466 DII	1999 - 2001
INTERNATIONAL/NAVIS' 4800	International/Navistar 530 Diesel	2002 - 2002
INTERNATIONAL/NAVIS' 4900	International/Navistar 530 Diesel	1995 - 2002
INTERNATIONAL/NAVIS' 4900	International/Navistar DT466 Diesel	2000 - 2002
INTERNATIONAL/NAVIS' 4900	INTERNATIONAL/NAVISTAR DT530E	2001 - 2001
INTERNATIONAL/NAVIS' 4900-210	INTERNATIONAL/NAVISTAR DT466 DII	1999 - 2000
INTERNATIONAL/NAVIS' 4900-250	INTERNATIONAL/NAVISTAR DT466 DII	1999 - 2000
INTERNATIONAL/NAVIS' 5500i	International/Navistar DT466 Diesel	2001 - 2002
INTERNATIONAL/NAVIS' 5600i	International/Navistar DT466 Diesel	2001 - 2002
INTERNATIONAL/NAVIS' 8100	International/Navistar 530 Diesel	1999 - 2003

## 38513



BLUEBIRD All American RE	Cummins ISC Diesel	1998 - 2000
FREIGHTLINER FL50	Cummins ISC Diesel	1998 - 1998
FREIGHTLINER FL60	Cummins ISC Diesel	1998 - 1998
FREIGHTLINER FL70	Cummins ISC Diesel	1998 - 1998
FREIGHTLINER FL80	Cummins ISC Diesel	1998 - 1999
FREIGHTLINER FLL70 - 14 TON	CUMMINS ISB DIESEL	2001 - 2001
KENWORTH T300	Cummins ISC Diesel	1999 - 1999
STERLING L-Line	Cummins ISC Diesel	2000 - 2003
THOMAS BUILT Saf-T-Liner MVP EF	Cummins ISB Diesel	2000 - 2002
THOMAS BUILT Saf-T-Liner MVP ER	Cummins ISC Diesel	1998 - 1998



### 38514



BLUEBIRD	Conventional	International/Navistar DT466 Diesel	1999 - 2004
FREIGHTLINER	FLD	Caterpillar C10 Diesel	1997 - 1997
FREIGHTLINER	FLD	Caterpillar C12 Diesel	1996 - 1997
INTERNATIONAL/NAVIS	3300	International/Navistar DT466 Diesel	2004 - 2004
INTERNATIONAL/NAVIS	3800	International/Navistar DT466 Diesel	1998 - 2001
INTERNATIONAL/NAVIS	4300	International/Navistar DT466 Diesel	2002 - 2004
INTERNATIONAL/NAVIS	4400	International/Navistar 530 Diesel	2002 - 2005
INTERNATIONAL/NAVIS	4400	International/Navistar DT466 Diesel	2002 - 2005
INTERNATIONAL/NAVIS	4700	International/Navistar 530 Diesel	1999 - 2002
INTERNATIONAL/NAVIS	4700	International/Navistar DT408 Diesel	1995 - 1997
INTERNATIONAL/NAVIS	4700	International/Navistar DT466 Diesel	1995 - 2002
INTERNATIONAL/NAVIS	4700 FBC	INTERNATIONAL/NAVISTAR DT466 DII	1999 - 2000
INTERNATIONAL/NAVIS	4700 SCD	INTERNATIONAL/NAVISTAR DT466 DII	1999 - 2001
INTERNATIONAL/NAVIS	4800	International/Navistar 530 Diesel	2002 - 2002
INTERNATIONAL/NAVIS	4800	International/Navistar DT408 Diesel	1995 - 1997
INTERNATIONAL/NAVIS	4800	International/Navistar DT466 Diesel	1995 - 2003
INTERNATIONAL/NAVIS	4900	International/Navistar 530 Diesel	1995 - 2002
INTERNATIONAL/NAVIS	4900	International/Navistar DT408 Diesel	1995 - 1997
INTERNATIONAL/NAVIS	4900	International/Navistar DT466 Diesel	1995 - 2002
INTERNATIONAL/NAVIS	4900	INTERNATIONAL/NAVISTAR DT530E	2001 - 2001
INTERNATIONAL/NAVIS	4900-210	INTERNATIONAL/NAVISTAR DT466 DII	1999 - 2000
INTERNATIONAL/NAVIS	4900-250	INTERNATIONAL/NAVISTAR DT466 DII	1999 - 2000
INTERNATIONAL/NAVIS	5500i	International/Navistar DT466 Diesel	2001 - 2002
INTERNATIONAL/NAVIS	5600i	International/Navistar DT466 Diesel	2001 - 2002
INTERNATIONAL/NAVIS	7100	International/Navistar DT466 Diesel	1995 - 1995
INTERNATIONAL/NAVIS	7300	International/Navistar DT466 Diesel	2002 - 2003
INTERNATIONAL/NAVIS	7400	International/Navistar 530 Diesel	2002 - 2003
INTERNATIONAL/NAVIS	7400	International/Navistar DT466 Diesel	2002 - 2003
INTERNATIONAL/NAVIS	7400	International/Navistar DT530 Diesel	2004 - 2005
INTERNATIONAL/NAVIS	7500	International/Navistar 530 Diesel	2002 - 2003
INTERNATIONAL/NAVIS	7500	International/Navistar DT466 Diesel	2002 - 2002
INTERNATIONAL/NAVIS	7500	International/Navistar DT530 Diesel	2004 - 2005
INTERNATIONAL/NAVIS	8100	Caterpillar 3176 Diesel	1995 - 1997
INTERNATIONAL/NAVIS	8100	International/Navistar 530 Diesel	1996 - 2003
INTERNATIONAL/NAVIS	8100	International/Navistar DT466 Diesel	1995 - 2000
INTERNATIONAL/NAVIS	8200	International/Navistar 530 Diesel	1996 - 1997
INTERNATIONAL/NAVIS	8200	International/Navistar DT466 Diesel	1997 - 1997
INTERNATIONAL/NAVIS	8500	International/Navistar 530 Diesel	2002 - 2005
INTERNATIONAL/NAVIS	CE	International/Navistar DT466 Diesel	2003 - 2004
INTERNATIONAL/NAVIS	Conventional IC	International/Navistar DT466 Diesel	2002 - 2003
INTERNATIONAL/NAVIS	FE	International/Navistar DT466 Diesel	2002 - 2004
INTERNATIONAL/NAVIS	RE	International/Navistar 530 Diesel	1998 - 2004
PETERBILT	378	Caterpillar C10 Diesel	2000 - 2001
PETERBILT	378	Caterpillar C12 Diesel	2000 - 2001
PETERBILT	379	Caterpillar C10 Diesel	2000 - 2001
PETERBILT	379	Caterpillar C12 Diesel	2000 - 2001

### 38516



BLUEBIRD	All American RE	Cummins ISB Diesel	1999 - 1999
BLUEBIRD	All American RE	Cummins ISC Diesel	2001 - 2003
BLUEBIRD	Conventional	Cummins ISB Diesel	2001 - 2001
BLUEBIRD	TC2000	Cummins ISB Diesel	1998 - 2000
DINA	102 F	CUMMINS ISB	2008 - 2008
DINA	104-F	CUMMINS ISB	2008 - 2008
DINA	104-SF	CUMMINS ISB	2008 - 2008
DINA	94 F	CUMMINS ISB	2008 - 2008
FORD	F650 Super Duty	Cummins ISB Diesel	2000 - 2004

FORD	F750 Super Duty	Cummins ISB Diesel	2000 - 2004
FREIGHTLINER	Business Class M2	Cummins ISC Diesel	2004 - 2006
FREIGHTLINER	FL50	Cummins B Series 5.9 L Diesel	1997 - 1997
FREIGHTLINER	FL50	Cummins ISB Diesel	1998 - 2003
FREIGHTLINER	FL50	Cummins ISC Diesel	1999 - 2005
FREIGHTLINER	FL60	Cummins B Series 5.9 L Diesel	1997 - 1997
FREIGHTLINER	FL60	Cummins ISB Diesel	1998 - 2003
FREIGHTLINER	FL60	Cummins ISC Diesel	1999 - 2004
FREIGHTLINER	FL70	Cummins B Series 5.9 L Diesel	1997 - 1997
FREIGHTLINER	FL70	Cummins ISB Diesel	1998 - 2003
FREIGHTLINER	FL70	Cummins ISC Diesel	1999 - 2005
FREIGHTLINER	FL80	Cummins B Series 5.9 L Diesel	1997 - 1997
FREIGHTLINER	FL80	Cummins ISB Diesel	1998 - 2003
FREIGHTLINER	FL80	Cummins ISC Diesel	2002 - 2005
FREIGHTLINER	UCBC	CUMMINS ISB DIESEL	2003 - 2003
KENWORTH	T300	Cummins ISC Diesel	2001 - 2006
KENWORTH	T800	CUMMINS ISL	2005 - 2006
KENWORTH	T800	Cummins ISL Diesel	2001 - 2008
KENWORTH	W900	Cummins ISB Diesel	2003 - 2004
PETERBILT	330	Cummins ISC Diesel	1999 - 2005
PETERBILT	335	Cummins ISC Diesel	2005 - 2006
STERLING	Acterra	Cummins ISC Diesel	2005 - 2008
STERLING	L-Line	Cummins ISB Diesel	2000 - 2000
THOMAS BUILT	Conventional	Cummins ISB Diesel	2000 - 2003
THOMAS BUILT	Saf-T-Liner MVP EF	Cummins ISB Diesel	2000 - 2002
THOMAS BUILT	Saf-T-Liner MVP ER	Cummins ISB Diesel	1999 - 2000
THOMAS BUILT	Saf-T-Liner MVP ER	Cummins ISC Diesel	2000 - 2000

### 38517



FORD	F600	Cummins B Series 5.9 L Diesel	1992 - 1994
FORD	F650 Super Duty	Cummins ISB Diesel	2005 - 2007
FORD	F750 Super Duty	Cummins ISB Diesel	2005 - 2007
FORD	F800	CUMMINS ISB DIESEL	1998 - 1998
FREIGHTLINER	FC70	Cummins ISB Diesel	2003 - 2003
FREIGHTLINER	FC80	Cummins ISB Diesel	2003 - 2003
FREIGHTLINER	UCBC	CUMMINS ISB DIESEL	2004 - 2004
KENWORTH	T300	Cummins ISB Diesel	2005 - 2005

### 38519



INTERNATIONAL/NAVIS	9100	Detroit Diesel Series 60 Diesel	1998 - 1998
INTERNATIONAL/NAVIS	9200	Detroit Diesel 6-Cyl. 11.1 L Diesel	1995 - 1997
INTERNATIONAL/NAVIS	9200	Detroit Diesel 6-Cyl. 12.7 L Diesel	1995 - 1997
INTERNATIONAL/NAVIS	9200	Detroit Diesel Series 60 Diesel	1998 - 1998
INTERNATIONAL/NAVIS	9400	Detroit Diesel 6-Cyl. 11.1 L Diesel	1995 - 1996
INTERNATIONAL/NAVIS	9400	Detroit Diesel 6-Cyl. 12.7 L Diesel	1995 - 1996
INTERNATIONAL/NAVIS	9400	Detroit Diesel Series 60 Diesel	1997 - 1999
INTERNATIONAL/NAVIS	9400i	Detroit Diesel 6-Cyl. 12.7 L Diesel	2001 - 2001
INTERNATIONAL/NAVIS	9400i	Detroit Diesel Series 60 Diesel	2000 - 2000
INTERNATIONAL/NAVIS	9600	Detroit Diesel 6-Cyl. 11.1 L Diesel	1996 - 1996
INTERNATIONAL/NAVIS	9600	Detroit Diesel 6-Cyl. 12.7 L Diesel	1995 - 1995
INTERNATIONAL/NAVIS	9700	Detroit Diesel 6-Cyl. 11.1 L Diesel	1996 - 1996
INTERNATIONAL/NAVIS	9700	Detroit Diesel 6-Cyl. 12.7 L Diesel	1996 - 1996
INTERNATIONAL/NAVIS	9800	Detroit Diesel Series 60 Diesel	1997 - 1997
INTERNATIONAL/NAVIS	9900	Detroit Diesel Series 60 Diesel	1999 - 1999
INTERNATIONAL/NAVIS	9900i	Detroit Diesel 6-Cyl. 12.7 L Diesel	2001 - 2001
INTERNATIONAL/NAVIS	9900i	Detroit Diesel Series 60 Diesel	2000 - 2000
INTERNATIONAL/NAVIS	9900ix	Detroit Diesel 6-Cyl. 12.7 L Diesel	2001 - 2001
INTERNATIONAL/NAVIS	9900ix	Detroit Diesel Series 60 Diesel	2000 - 2000



### 38521



FREIGHTLINER	Argosy	Cummins ISM Diesel	2000 - 2000
FREIGHTLINER	Century Class	Cummins ISM Diesel	1998 - 2001
FREIGHTLINER	Classic	Cummins ISM Diesel	2001 - 2003
FREIGHTLINER	Classic XL	Cummins ISM Diesel	2001 - 2003
FREIGHTLINER	Columbia	Cummins ISM Diesel	2001 - 2003
FREIGHTLINER	Condor	Cummins ISM Diesel	2001 - 2002
FREIGHTLINER	FL112	Cummins ISM Diesel	2000 - 2003
FREIGHTLINER	FLD	Cummins ISM Diesel	2000 - 2003
INTERNATIONAL/NAVIS	5500	CUMMINS ISM DIESEL	2005 - 2005
INTERNATIONAL/NAVIS	5500i	Cummins ISM Diesel	2002 - 2004
INTERNATIONAL/NAVIS	5600	CUMMINS ISM DIESEL	2005 - 2005
INTERNATIONAL/NAVIS	5600i	Cummins ISM Diesel	2002 - 2004
INTERNATIONAL/NAVIS	5900i	Cummins ISM Diesel	2001 - 2004
INTERNATIONAL/NAVIS	7600	Cummins ISM Diesel	2003 - 2004
INTERNATIONAL/NAVIS	8600	Cummins ISM Diesel	2003 - 2004
INTERNATIONAL/NAVIS	9000 SERIES	CUMMINS ISM DIESEL	2004 - 2004
INTERNATIONAL/NAVIS	9200	CUMMINS ISM DIESEL	2005 - 2005
INTERNATIONAL/NAVIS	9200i	Cummins ISM Diesel	2003 - 2004
INTERNATIONAL/NAVIS	9400i	Cummins ISM Diesel	2004 - 2005
INTERNATIONAL/NAVIS	ProStar Series	Cummins ISX Diesel	2008 - 2008
KENWORTH	T600	Cummins ISM Diesel	2001 - 2004
KENWORTH	T800	Cummins ISM Diesel	1999 - 2004
KENWORTH	W900	Cummins ISM Diesel	2002 - 2004
PETERBILT	320	Cummins ISM Diesel	2007 - 2007
PETERBILT	357	Cummins ISM Diesel	2001 - 2004
PETERBILT	378	Cummins ISM Diesel	2001 - 2001
PETERBILT	385	Cummins ISM Diesel	2002 - 2004
PETERBILT	387	Cummins ISM Diesel	2000 - 2000

FREIGHTLINER	Argosy	Caterpillar C10 Diesel	2000 - 2003
FREIGHTLINER	Argosy	Caterpillar C12 Diesel	2000 - 2004
FREIGHTLINER	Century Class	Caterpillar C10 Diesel	2001 - 2003
FREIGHTLINER	Century Class	Caterpillar C12 Diesel	2001 - 2004
FREIGHTLINER	Columbia	Caterpillar C10 Diesel	2001 - 2003
FREIGHTLINER	Columbia	Caterpillar C12 Diesel	2003 - 2004
FREIGHTLINER	Condor	Caterpillar C10 Diesel	2001 - 2004
FREIGHTLINER	Condor	Caterpillar C12 Diesel	2001 - 2004
FREIGHTLINER	FL112	Caterpillar C10 Diesel	2001 - 2004
FREIGHTLINER	FL112	Caterpillar C12 Diesel	2001 - 2004
FREIGHTLINER	FLD	Caterpillar C10 Diesel	2001 - 2004
FREIGHTLINER	FLD	Caterpillar C12 Diesel	2001 - 2004
STERLING	A-Line	Caterpillar C10 Diesel	2002 - 2004
STERLING	A-Line	Caterpillar C12 Diesel	2002 - 2004

### 38525



BLUEBIRD	All American RE	Cummins ISC Diesel	2004 - 2004
BLUEBIRD	Vision	Cummins ISB Diesel	2006 - 2006
FREIGHTLINER	FL50	Cummins ISC Diesel	2000 - 2001
FREIGHTLINER	FL60	Cummins ISC Diesel	2000 - 2001
FREIGHTLINER	FL70	Cummins ISC Diesel	2000 - 2001
FREIGHTLINER	FL80	Cummins ISC Diesel	2000 - 2001
PETERBILT	330	Cummins ISB Diesel	2000 - 2000

### 38527



KENWORTH	T300	Cummins ISC Diesel	2000 - 2000
----------	------	--------------------	-------------

### 38529



MACK	CH Series	Mack 6-Cyl. 12.0 L Diesel	2001 - 2002
MACK	CH Series	Mack AC Diesel	2003 - 2006
MACK	CHN Series	Mack AC Diesel	2006 - 2007
MACK	CL Series	Mack 6-Cyl. 12.0 L Diesel	2001 - 2001
MACK	CS Series	Mack AC Diesel	2003 - 2003
MACK	CV Series	Mack 6-Cyl. 12.0 L Diesel	2001 - 2002
MACK	CV SERIES	MACK AI DIESEL	2005 - 2007
MACK	CV Series	Mack AMI Diesel	2003 - 2006
MACK	CX Series	Mack 6-Cyl. 12.0 L Diesel	2001 - 2002
MACK	CXN Series	Mack AC Diesel	2006 - 2007
MACK	CXP Series	Mack MP7 Diesel	2006 - 2006
MACK	DM Series	Mack 6-Cyl. 12.0 L Diesel	2001 - 2001
MACK	LE Series	Mack AI Diesel	2003 - 2005
MACK	MR Series	Mack 6-Cyl. 12.0 L Diesel	2001 - 2002
MACK	RD Series	Mack 6-Cyl. 12.0 L Diesel	2001 - 2002
MACK	RD Series	Mack E7 Diesel	2003 - 2003

INTERNATIONAL/NAVIS	9100	Detroit Diesel Series 60 Diesel	1999 - 1999
INTERNATIONAL/NAVIS	9100i	Detroit Diesel 6-Cyl. 12.7 L Diesel	2001 - 2003
INTERNATIONAL/NAVIS	9100i	Detroit Diesel Series 60 Diesel	2000 - 2000
INTERNATIONAL/NAVIS	9200	Detroit Diesel Series 60 Diesel	1999 - 1999
INTERNATIONAL/NAVIS	9200i	Detroit Diesel 6-Cyl. 12.7 L Diesel	2001 - 2001
INTERNATIONAL/NAVIS	9200i	Detroit Diesel Series 60 Diesel	2000 - 2000

### 38531



VOLVO	7550	7550	2001 - 2006
VOLVO	7550 FL	7550 FL	2005 - 2008
VOLVO	9700	9700	2002 - 2006
VOLVO	WG Series	Volvo VE D12 Diesel	1998 - 2001

### 38524





### 38532



FREIGHTLINER	Argosy	Cummins ISX Diesel	1999 - 2003
FREIGHTLINER	Century Class	Cummins ISX Diesel	2000 - 2001
FREIGHTLINER	Columbia	Cummins ISX Diesel	2001 - 2001
FREIGHTLINER	FLD	Cummins ISX Diesel	1999 - 2003
INTERNATIONAL/NAVIS	9100i	Cummins ISX Diesel	2001 - 2003
INTERNATIONAL/NAVIS	9200i	Cummins Signature 600 Diesel	2000 - 2002
INTERNATIONAL/NAVIS	9400i	Cummins ISX Diesel	2000 - 2002
INTERNATIONAL/NAVIS	9900i	Cummins ISX Diesel	2000 - 2003
INTERNATIONAL/NAVIS	9900ix	Cummins ISX Diesel	2000 - 2003
KENWORTH	T2000	Cummins ISX Diesel	1999 - 2003
KENWORTH	T600	Cummins ISX Diesel	2002 - 2003
KENWORTH	T600	Cummins Signature 600 Diesel	2003 - 2003
KENWORTH	T800	Cummins ISX Diesel	1999 - 2003
KENWORTH	W900	Cummins ISX Diesel	1999 - 2003
KENWORTH	W900	Cummins Signature 600 Diesel	2000 - 2002
MACK	CH Series	Cummins Signature 600 Diesel	2001 - 2003
MACK	CL Series	Cummins Signature 600 Diesel	2001 - 2003
PETERBILT	378	Cummins ISX Diesel	2000 - 2002
PETERBILT	378	Cummins Signature 600 Diesel	2000 - 2002
PETERBILT	379	Cummins ISX Diesel	1998 - 2002
PETERBILT	379	Cummins Signature 600 Diesel	2000 - 2002
PETERBILT	387	Cummins ISX Diesel	2001 - 2002
PETERBILT	387	Cummins Signature 600 Diesel	2001 - 2002
STERLING	L-Line	Cummins ISX Diesel	2001 - 2001
STERLING	L-LINE	CUMMINS SIGNATURE 600	2001 - 2001
STERLING	L-Line	Cummins Signature 600 Diesel	2001 - 2001
VOLVO	VN Series	Cummins ISX Diesel	2000 - 2003
VOLVO	VN Series	Cummins Signature 600 Diesel	2003 - 2003

FREIGHTLINER	Columbia	Cummins ISX Diesel	2001 - 2001
FREIGHTLINER	FLD	Cummins ISX Diesel	1999 - 2003
INTERNATIONAL/NAVIS	9100i	Cummins ISX Diesel	2001 - 2003
INTERNATIONAL/NAVIS	9200i	Cummins Signature 600 Diesel	2000 - 2002
INTERNATIONAL/NAVIS	9400i	Cummins ISX Diesel	2000 - 2002
INTERNATIONAL/NAVIS	9900i	Cummins ISX Diesel	2000 - 2003
INTERNATIONAL/NAVIS	9900ix	Cummins ISX Diesel	2000 - 2003
KENWORTH	T2000	Cummins ISX Diesel	1999 - 2003
KENWORTH	T600	Cummins ISX Diesel	2002 - 2003
KENWORTH	T600	Cummins Signature 600 Diesel	2003 - 2003
KENWORTH	T800	Cummins ISX Diesel	1999 - 2003
KENWORTH	W900	Cummins ISX Diesel	1999 - 2003
KENWORTH	W900	Cummins Signature 600 Diesel	2000 - 2002
MACK	CH Series	Cummins Signature 600 Diesel	2001 - 2003
MACK	CL Series	Cummins Signature 600 Diesel	2001 - 2003
PETERBILT	378	Cummins ISX Diesel	2000 - 2002
PETERBILT	378	Cummins Signature 600 Diesel	2000 - 2002
PETERBILT	379	Cummins ISX Diesel	1998 - 2002
PETERBILT	379	Cummins Signature 600 Diesel	2000 - 2002
PETERBILT	387	Cummins ISX Diesel	2001 - 2002
PETERBILT	387	Cummins Signature 600 Diesel	2001 - 2002
STERLING	L-Line	Cummins ISX Diesel	2001 - 2001
STERLING	L-LINE	CUMMINS SIGNATURE 600	2001 - 2001
STERLING	L-Line	Cummins Signature 600 Diesel	2001 - 2001
VOLVO	VN Series	Cummins ISX Diesel	2000 - 2003
VOLVO	VN Series	Cummins Signature 600 Diesel	2003 - 2003

### 38536



VOLVO	VN Series	Cummins N14 Diesel	2000 - 2002
VOLVO	VNL	CUMMINS N14	2002 - 2003
VOLVO	VNM	CUMMINS N14	2002 - 2003

### 38534



FREIGHTLINER	Century Class	Caterpillar C10 Diesel	1999 - 2000
FREIGHTLINER	Century Class	Caterpillar C12 Diesel	1999 - 2000
FREIGHTLINER	FL112	Caterpillar C10 Diesel	1999 - 2000
FREIGHTLINER	FL112	Caterpillar C12 Diesel	1999 - 2000
FREIGHTLINER	FLD	Caterpillar C10 Diesel	1998 - 2000
FREIGHTLINER	FLD	Caterpillar C12 Diesel	1998 - 2000
INTERNATIONAL/NAVIS	5500i	Caterpillar C10 Diesel	2003 - 2004
INTERNATIONAL/NAVIS	5500i	Caterpillar C12 Diesel	2003 - 2004
INTERNATIONAL/NAVIS	5600i	Caterpillar C10 Diesel	2003 - 2004
INTERNATIONAL/NAVIS	5600i	Caterpillar C12 Diesel	2003 - 2004
INTERNATIONAL/NAVIS	5900i	Caterpillar C10 Diesel	2003 - 2003
INTERNATIONAL/NAVIS	5900i	Caterpillar C12 Diesel	2003 - 2004
INTERNATIONAL/NAVIS	7600	Caterpillar C10 Diesel	2004 - 2004
INTERNATIONAL/NAVIS	7600	Caterpillar C12 Diesel	2004 - 2004

### 38539



VOLVO	VHD	Cummins ISM Diesel	2002 - 2003
VOLVO	VN Series	Cummins ISM Diesel	2002 - 2003

### 38540



FREIGHTLINER	Century Class	Mercedes-Benz MBE 4000 Diesel	2004 - 2004
FREIGHTLINER	Columbia	Mercedes-Benz MBE 4000 Diesel	2003 - 2004
FREIGHTLINER	FL112	Mercedes-Benz MBE 4000 Diesel	2003 - 2004

### 38535



FREIGHTLINER	Argosy	Cummins ISX Diesel	1999 - 2003
FREIGHTLINER	Century Class	Cummins ISX Diesel	2000 - 2001



**38541**



FREIGHTLINER	Century Class	Mercedes-Benz MBE 4000 Diesel	2004 - 2004
FREIGHTLINER	Columbia	Mercedes-Benz MBE 4000 Diesel	2003 - 2004
FREIGHTLINER	FL112	Mercedes-Benz MBE 4000 Diesel	2003 - 2004

**38556**



FORD	F650 Super Duty	Ford V-8 6.0 L Diesel	2003 - 2006
FORD	F750 Super Duty	Ford V-8 6.0 L Diesel	2003 - 2006
INTERNATIONAL/NAVIS	4100	International/Navistar VT365 Diesel	2006 - 2007
INTERNATIONAL/NAVIS	4200	International/Navistar VT365 Diesel	2002 - 2007
INTERNATIONAL/NAVIS	4300	International/Navistar VT365 Diesel	2003 - 2003
INTERNATIONAL/NAVIS	4400	International/Navistar VT365 Diesel	2003 - 2003
INTERNATIONAL/NAVIS	BE	International/Navistar MaxxForce 7 Dies	2008 - 2008
INTERNATIONAL/NAVIS	BE	International/Navistar VT365 Diesel	2007 - 2008
INTERNATIONAL/NAVIS	CE	International/Navistar VT365 Diesel	2005 - 2007
INTERNATIONAL/NAVIS	DuraStar 4300	International/Navistar MaxxForce 7 Dies	2008 - 2008
INTERNATIONAL/NAVIS	DuraStar 4300	International/Navistar MaxxForce DT Di	2008 - 2008

**38545**



VOLVO	VN Series	Cummins ISM Diesel	2001 - 2001
-------	-----------	--------------------	-------------

**38557**



CHEVROLET	C6500	Caterpillar 3126 Diesel	2003 - 2003
CHEVROLET	C7500	Caterpillar 3126 Diesel	2003 - 2003
CHEVROLET	C8500	Caterpillar 3126 Diesel	2003 - 2003

**38547**



VOLVO	VHD	Volvo VE D12 Diesel	2001 - 2002
-------	-----	---------------------	-------------

**38567**



FREIGHTLINER	Business Class M2	Mercedes-Benz MBE 900 Diesel	2004 - 2008
STERLING	ACTERRA	MERCEDES-BENZ MBE 900 DIESEL	2003 - 2004
THOMAS BUILT	Conventional	Mercedes-Benz MBE 900 Diesel	2006 - 2006
THOMAS BUILT	Saf-T-Liner C2	Mercedes-Benz MBE 900 Diesel	2008 - 2009

**38548**



CHEVROLET	C6500	Isuzu 6HK1-TC Diesel	2003 - 2006
CHEVROLET	C7500	Isuzu 6HK1-TC Diesel	2003 - 2006
CHEVROLET	C8500	Isuzu 6HK1-TC Diesel	2003 - 2006

**38569**



FREIGHTLINER	Century Class	Caterpillar C15 Diesel	2005 - 2006
FREIGHTLINER	Classic XL	Caterpillar C15 Diesel	2005 - 2005
FREIGHTLINER	Columbia	Caterpillar C15 Diesel	2005 - 2005
FREIGHTLINER	Coronado	Caterpillar C15 Diesel	2005 - 2006
FREIGHTLINER	FLD	Caterpillar C15 Diesel	2005 - 2008
INTERNATIONAL/NAVIS	5600i	Caterpillar C15 Diesel	2004 - 2004
INTERNATIONAL/NAVIS	5900i	Caterpillar C15 Diesel	2004 - 2006
INTERNATIONAL/NAVIS	9400i	Caterpillar C15 Diesel	2004 - 2007
INTERNATIONAL/NAVIS	9900i	Caterpillar C15 Diesel	2004 - 2007
INTERNATIONAL/NAVIS	9900ix	Caterpillar C15 Diesel	2004 - 2007
INTERNATIONAL/NAVIS	PayStar 5600i	Caterpillar C15 Diesel	2008 - 2008
KENWORTH	T2000	Caterpillar C15 Diesel	2004 - 2007
KENWORTH	T600	Caterpillar C15 Diesel	2007 - 2007
KENWORTH	T800	Caterpillar C15 Diesel	2005 - 2007

**38550**



BLUEBIRD	Vision	Caterpillar C7 Diesel	2006 - 2007
FORD	F650 Super Duty	Caterpillar C7 Diesel	2004 - 2006
FORD	F750 Super Duty	Caterpillar C7 Diesel	2004 - 2006
FREIGHTLINER	Business Class M2	Caterpillar 3126 Diesel	2002 - 2007
FREIGHTLINER	Business Class M2	Caterpillar C7 Diesel	2004 - 2007
FREIGHTLINER	Business Class M2	Caterpillar C9 Diesel	2004 - 2007
STERLING	L-LINE	CATERPILLAR C7 DIESEL	2005 - 2005
THOMAS BUILT	Saf-T-Liner C2	Caterpillar C7 Diesel	2008 - 2008
THOMAS BUILT	Saf-T-Liner MVP EF	Caterpillar C7 Diesel	2005 - 2006
THOMAS BUILT	Saf-T-Liner MVP ER	Caterpillar C7 Diesel	2004 - 2005





# Catálogo de Poleas, Tensores y Kits 2009

KENWORTH	W900	Caterpillar C15 Diesel	2004 - 2007
PETERBILT	357	Caterpillar C15 Diesel	2004 - 2006
PETERBILT	378	Caterpillar C15 Diesel	2003 - 2006
PETERBILT	379	Caterpillar C15 Diesel	2004 - 2007
PETERBILT	387	Caterpillar C15 Diesel	2004 - 2007

## 38579



CHEVROLET	T6500	Isuzu 6HK1-TC Diesel	2005 - 2008
CHEVROLET	T7500	Isuzu 6HK1-TC Diesel	2005 - 2008
CHEVROLET	T8500	Isuzu 6HK1-TC Diesel	2005 - 2008

## 38581



VOLVO	VHD	Volvo VE 12 Diesel	2002 - 2002
VOLVO	VHD	Volvo VE D12 Diesel	2003 - 2008
VOLVO	VN Series	Volvo D16 Diesel	2008 - 2008
VOLVO	VN Series	Volvo VE D12 Diesel	2004 - 2008
VOLVO	VN Series	Volvo VE D16 Diesel	2006 - 2008
VOLVO	VT Series	Volvo VE D16 Diesel	2006 - 2008

## 38584



VOLKSWAGEN	15-190 WORKER	Cummins Interact 5.9 DIESEL (EURO III)	2005 - 2008
VOLKSWAGEN	17-210 VOLKSBUS	MWM de 6.2 DIESEL ELECTRONICO	2005 - 2008
VOLKSWAGEN	17-250 WORKER	Cummins Interact 5.9 DIESEL (EURO III)	2005 - 2008
VOLKSWAGEN	24-250 WORKER	Cummins Interact 5.9 DIESEL (EURO III)	2005 - 2008
VOLKSWAGEN	8-150 VOLKSBUS	Cummins Interact 3.9 DIESEL (EURO III)	2005 - 2008
VOLKSWAGEN	8-150 WORKER	Cummins Interact 3.9 DIESEL (EURO III)	2005 - 2008

## 38585



VOLVO	VHD	Volvo VE D12 Diesel	2005 - 2008
VOLVO	VN Series	Volvo D16 Diesel	2008 - 2008
VOLVO	VN Series	Volvo VE D12 Diesel	2004 - 2008
VOLVO	VN Series	Volvo VE D16 Diesel	2006 - 2008
VOLVO	VT Series	Volvo VE D16 Diesel	2006 - 2008

## 38586



CHEVROLET	C6500	Caterpillar C7 Diesel	2004 - 2007
CHEVROLET	C7500	Caterpillar C7 Diesel	2004 - 2007
CHEVROLET	C8500	Caterpillar C7 Diesel	2004 - 2007
KENWORTH	T300	Caterpillar C7 Diesel	2004 - 2007
PETERBILT	330	Caterpillar C7 Diesel	2004 - 2007
PETERBILT	335	Caterpillar C7 Diesel	2005 - 2007
STERLING	L-Line	Caterpillar C7 Diesel	2007 - 2007

## 38587



INTERNATIONAL/NAVIS	5500i	Cummins ISX Diesel	2003 - 2007
INTERNATIONAL/NAVIS	5600i	Cummins ISX Diesel	2005 - 2007
INTERNATIONAL/NAVIS	5900i	Cummins ISX Diesel	2003 - 2007
INTERNATIONAL/NAVIS	9200i	Cummins ISX Diesel	2003 - 2007
INTERNATIONAL/NAVIS	9400i	Cummins ISX Diesel	2003 - 2007
INTERNATIONAL/NAVIS	9900i	Cummins ISX Diesel	2003 - 2007
INTERNATIONAL/NAVIS	9900ix	Cummins ISX Diesel	2003 - 2007
INTERNATIONAL/NAVIS	PayStar 5500i	Cummins ISX Diesel	2008 - 2008
INTERNATIONAL/NAVIS	PayStar 5900i	Cummins ISX Diesel	2008 - 2008
KENWORTH	T2000	Cummins ISX Diesel	2004 - 2006
KENWORTH	T600	Cummins ISX Diesel	2004 - 2007
KENWORTH	T660	Cummins ISX Diesel	2007 - 2008
KENWORTH	T800	Cummins ISX Diesel	2004 - 2008
KENWORTH	W900	Cummins ISX Diesel	2003 - 2007
MACK	CL Series	Cummins ISX Diesel	2004 - 2007
PETERBILT	357	Cummins ISX Diesel	2006 - 2006
PETERBILT	367	Cummins ISX Diesel	2007 - 2008
PETERBILT	378	Cummins ISX Diesel	2004 - 2007
PETERBILT	379	Cummins ISX Diesel	2003 - 2007
PETERBILT	386	Cummins ISX Diesel	2008 - 2008
PETERBILT	387	Cummins ISX Diesel	2004 - 2006
PETERBILT	389	Cummins ISX Diesel	2008 - 2008
VOLVO	VN Series	Cummins ISX Diesel	2003 - 2007
VOLVO	VN Series	Cummins Signature 600 Diesel	2003 - 2003
VOLVO	VT Series	Cummins ISX Diesel	2006 - 2006

## 38589



MACK	CH Series	Mack AC Diesel	2003 - 2006
MACK	CHN Series	Mack AC Diesel	2006 - 2007
MACK	CT Series	Mack AI Diesel	2006 - 2007
MACK	CT Series	Mack AMI Diesel	2006 - 2006
MACK	CV Series	Mack AI Diesel	2006 - 2007
MACK	CV Series	Mack AMI Diesel	2004 - 2005
MACK	CX Series	Mack AC Diesel	2003 - 2006
MACK	CXN Series	Mack AC Diesel	2006 - 2007
MACK	CXP Series	Mack MP7 Diesel	2006 - 2006
MACK	MR Series	Mack AMI Diesel	2003 - 2005



**38590**



FREIGHTLINER	Business Class M2	Caterpillar C13 Diesel	2004 - 2007
FREIGHTLINER	Century Class	Caterpillar C11 Diesel	2006 - 2006
FREIGHTLINER	Century Class	Caterpillar C13 Diesel	2006 - 2006
FREIGHTLINER	Columbia	Caterpillar C11 Diesel	2004 - 2007
FREIGHTLINER	Columbia	Caterpillar C13 Diesel	2004 - 2008
FREIGHTLINER	Condor	Caterpillar C11 Diesel	2005 - 2005
FREIGHTLINER	Condor	Caterpillar C13 Diesel	2005 - 2005
FREIGHTLINER	FLD	Caterpillar C11 Diesel	2005 - 2007
FREIGHTLINER	FLD	Caterpillar C13 Diesel	2005 - 2007
INTERNATIONAL/NAVIS	5500i	Caterpillar C13 Diesel	2005 - 2007
INTERNATIONAL/NAVIS	5600i	Caterpillar C13 Diesel	2005 - 2005
INTERNATIONAL/NAVIS	7600	Caterpillar C11 Diesel	2004 - 2007
INTERNATIONAL/NAVIS	7600	Caterpillar C13 Diesel	2004 - 2008
INTERNATIONAL/NAVIS	7700	Caterpillar C11 Diesel	2005 - 2006
INTERNATIONAL/NAVIS	7700	Caterpillar C13 Diesel	2005 - 2006
INTERNATIONAL/NAVIS	8600	Caterpillar C11 Diesel	2004 - 2007
INTERNATIONAL/NAVIS	8600	Caterpillar C13 Diesel	2004 - 2007
INTERNATIONAL/NAVIS	9200i	Caterpillar C13 Diesel	2004 - 2006
INTERNATIONAL/NAVIS	9400i	Caterpillar C13 Diesel	2004 - 2007
KENWORTH	T800	Caterpillar C11 Diesel	2003 - 2008
KENWORTH	T800	Caterpillar C13 Diesel	2004 - 2007
KENWORTH	W900	Caterpillar C11 Diesel	2005 - 2007
KENWORTH	W900	Caterpillar C13 Diesel	2004 - 2007
PETERBILT	357	Caterpillar C11 Diesel	2006 - 2007
PETERBILT	357	Caterpillar C13 Diesel	2005 - 2007
PETERBILT	378	Caterpillar C13 Diesel	2005 - 2005
PETERBILT	379	Caterpillar C11 Diesel	2005 - 2006
PETERBILT	379	Caterpillar C13 Diesel	2004 - 2006
PETERBILT	385	Caterpillar C13 Diesel	2005 - 2006
PETERBILT	386	Caterpillar C13 Diesel	2007 - 2007
PETERBILT	387	Caterpillar C13 Diesel	2004 - 2005
STERLING	Acterra	Caterpillar C13 Diesel	2006 - 2006
STERLING	A-Line	Caterpillar C11 Diesel	2004 - 2006
STERLING	A-Line	Caterpillar C13 Diesel	2005 - 2006
STERLING	A-Line	Caterpillar C15 Diesel	2005 - 2006
STERLING	L-Line	Caterpillar C11 Diesel	2004 - 2007
STERLING	L-Line	Caterpillar C13 Diesel	2004 - 2007
STERLING	L-Line	Caterpillar C15 Diesel	2005 - 2007
STERLING	L-Line	Caterpillar C9 Diesel	2005 - 2007

**38597**

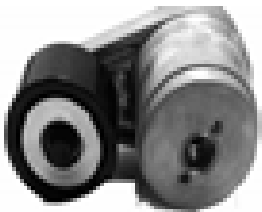

FREIGHTLINER	Business Class M2	Mercedes-Benz MBE 4000 Diesel	2004 - 2007
FREIGHTLINER	Century Class	Mercedes-Benz MBE 4000 Diesel	2005 - 2005
FREIGHTLINER	Columbia	Mercedes-Benz MBE 4000 Diesel	2005 - 2007
STERLING	A-Line	Mercedes-Benz MBE 4000 Diesel	2004 - 2008
STERLING	L-Line	Mercedes-Benz MBE 4000 Diesel	2003 - 2007

**38598**



FREIGHTLINER Business Class M2 Mercedes-Benz MBE 900 Diesel 2006 - 2007

**38599**



MACK	LE Series	Mack AI Diesel	2004 - 2006
MACK	MR Series	Mack AI Diesel	2005 - 2006
MACK	MR Series	Mack AMI Diesel	2003 - 2007

**38607**



MACK	CTP Series	Mack MP7 Diesel	2007 - 2007
MACK	CXP Series	Mack MP7 Diesel	2007 - 2007
VOLVO	9700 FL	9700 FL	2005 - 2008
VOLVO	VHD	Cummins ISM Diesel	2002 - 2003
VOLVO	VN Series	Cummins ISM Diesel	2002 - 2003

**38611**



MACK	CX Series	Mack AC Diesel	2003 - 2005
------	-----------	----------------	-------------

**38617**



MACK	CX Series	Mack AC Diesel	2006 - 2006
------	-----------	----------------	-------------

**38620**



INTERNATIONAL/NAVIS	4300	International/Navistar DT466 Diesel	2005 - 2008
INTERNATIONAL/NAVIS	4400	International/Navistar DT466 Diesel	2006 - 2008
INTERNATIONAL/NAVIS	4400	International/Navistar DT570 Diesel	2004 - 2008
INTERNATIONAL/NAVIS	7300	International/Navistar DT466 Diesel	2005 - 2006
INTERNATIONAL/NAVIS	7400	International/Navistar 570 Diesel	2006 - 2006
INTERNATIONAL/NAVIS	7400	International/Navistar DT466 Diesel	2005 - 2007
INTERNATIONAL/NAVIS	7400	International/Navistar DT570 Diesel	2005 - 2007
INTERNATIONAL/NAVIS	7500	International/Navistar HT570 Diesel	2005 - 2007
INTERNATIONAL/NAVIS	8500	International/Navistar DT570 Diesel	2006 - 2006
INTERNATIONAL/NAVIS	8500	International/Navistar HT570 Diesel	2005 - 2007



INTERNATIONAL/NAVIS' 8600	International/Navistar HT570 Diesel	2005 - 2005
INTERNATIONAL/NAVIS' CE	International/Navistar DT466 Diesel	2005 - 2008
INTERNATIONAL/NAVIS' CE	International/Navistar MaxxForce DT Die	2008 - 2008
INTERNATIONAL/NAVIS' CXT	International/Navistar DT466 Diesel	2005 - 2006
INTERNATIONAL/NAVIS' FE	International/Navistar DT466 Diesel	2005 - 2005
INTERNATIONAL/NAVIS' RE	International/Navistar DT466 Diesel	1998 - 2007
INTERNATIONAL/NAVIS' RXT	International/Navistar DT570 Diesel	2006 - 2006

**38622**



INTERNATIONAL/NAVIS' 5500i	Cummins ISM Diesel	2005 - 2006
INTERNATIONAL/NAVIS' 5600i	Cummins ISM Diesel	2005 - 2007
INTERNATIONAL/NAVIS' 5900i	Cummins ISM Diesel	2005 - 2006
INTERNATIONAL/NAVIS' 7400	Cummins ISM Diesel	2005 - 2005
INTERNATIONAL/NAVIS' 7600	Cummins ISM Diesel	2005 - 2007
INTERNATIONAL/NAVIS' 7700	Cummins ISM Diesel	2005 - 2006
INTERNATIONAL/NAVIS' 8600	Cummins ISM Diesel	2005 - 2007
INTERNATIONAL/NAVIS' 9200i	Cummins ISM Diesel	2005 - 2007
INTERNATIONAL/NAVIS' 9400i	Cummins ISM Diesel	2006 - 2007
INTERNATIONAL/NAVIS' TranStar 8600	Cummins ISM Diesel	2008 - 2008
INTERNATIONAL/NAVIS' WorkStar 7600	Cummins ISM Diesel	2008 - 2008
KENWORTH T800	Cummins ISM Diesel	2005 - 2006
KENWORTH W900	Cummins ISM Diesel	2005 - 2006
PETERBILT 357	Cummins ISM Diesel	2005 - 2007
PETERBILT 365	Cummins ISM Diesel	2007 - 2007
PETERBILT 378	Cummins ISM Diesel	2004 - 2007
PETERBILT 385	Cummins ISM Diesel	2005 - 2005

## Tablas de Equivalencias

Intercambio	Gates
21004	21014
21005	21008
21006	21013
21008	21017
21009	21025
21017	21020
21020	21024
21022	21021
21023	21018
21024	21040
21025	21023
21026	21027
21027	21032
21028	21026
21029	21030
21031	21037
21034	21028
21035	21022
21036	21027
21037	21035
21038	21031
21039	21034
21040	21029
21041	21033
21042	21038
21043	21036
21044	21039
21045	21037
21046	21035
21047	21031
21048	21034
21049	21039
21050	21033
21051	21038
21052	21036
21053	21039
21054	21037
21055	21035
21056	21031
21057	21034
21058	21039
21059	21033
21060	21038
21061	21036
21062	21039
21063	21037
21064	21035
21065	21031
21066	21034
21067	21039
21068	21033
21069	21038
21070	21036
21071	21039
21072	21037
21073	21035
21074	21031
21075	21034
21076	21039
21077	21033
21078	21038
21079	21036
21080	21039
21081	21037
21082	21035
21083	21031
21084	21034
21085	21039
21086	21033
21087	21038
21088	21036
21089	21039
21090	21037
21091	21035
21092	21031
21093	21034
21094	21039
21095	21033
21096	21038
21097	21036
21098	21039
21099	21037

Intercambio	Gates
21007	21015
21017	21009
21018	21017
21019	21008
21019	21012
21019	21021
21020	21020
21020	21028
21021	21019
21021	21025
21021	21032
21021	21038
21022	21024
21022	21031
21022	21037
21023	21026
21023	21033
21023	21039
21024	21022
21024	21029
21024	21035
21025	21023
21025	21030
21025	21036
21026	21027
21026	21034
21027	21032
21027	21038
21028	21020
21028	21027
21028	21033
21028	21039
21029	21025
21029	21032
21029	21038
21030	21021
21030	21028
21030	21034
21031	21019
21031	21026
21031	21032
21031	21038
21032	21021
21032	21028
21032	21034
21033	21019
21033	21026
21033	21032
21033	21038
21034	21022
21034	21029
21034	21035
21035	21023
21035	21030
21035	21036
21036	21027
21036	21033
21036	21039
21037	21025
21037	21032
21037	21038
21038	21021
21038	21028
21038	21034
21039	21019
21039	21026
21039	21032
21039	21038
21040	21022
21040	21029
21040	21035
21041	21023
21041	21030
21041	21036
21042	21027
21042	21033
21042	21039
21043	21025
21043	21032
21043	21038
21044	21021
21044	21028
21044	21034
21045	21019
21045	21026
21045	21032
21045	21038
21046	21022
21046	21029
21046	21035
21047	21023
21047	21030
21047	21036
21048	21027
21048	21033
21048	21039
21049	21025
21049	21032
21049	21038
21050	21021
21050	21028
21050	21034
21051	21019
21051	21026
21051	21032
21051	21038
21052	21022
21052	21029
21052	21035
21053	21023
21053	21030
21053	21036
21054	21027
21054	21033
21054	21039
21055	21025
21055	21032
21055	21038
21056	21021
21056	21028
21056	21034
21057	21019
21057	21026
21057	21032
21057	21038
21058	21022
21058	21029
21058	21035
21059	21023
21059	21030
21059	21036
21060	21027
21060	21033
21060	21039
21061	21025
21061	21032
21061	21038
21062	21021
21062	21028
21062	21034
21063	21019
21063	21026
21063	21032
21063	21038
21064	21022
21064	21029
21064	21035
21065	21023
21065	21030
21065	21036
21066	21027
21066	21033
21066	21039
21067	21025
21067	21032
21067	21038
21068	21021
21068	21028
21068	21034
21069	21019
21069	21026
21069	21032
21069	21038
21070	21022
21070	21029
21070	21035
21071	21023
21071	21030
21071	21036
21072	21027
21072	21033
21072	21039
21073	21025
21073	21032
21073	21038
21074	21021
21074	21028
21074	21034

Intercambio	Gates
21028	21020
21028	21028
21028	21033
21028	21039
21027	21033
21027	21038
21028	21034
21028	21040
21028	21046
21028	21052
21028	21058
21028	21064
21028	21070
21028	21076
21028	21082
21028	21088
21028	21094
21028	21100
21028	21106
21028	21112
21028	21118
21028	21124
21028	21130
21028	21136
21028	21142
21028	21148
21028	21154
21028	21160
21028	21166
21028	21172
21028	21178
21028	21184
21028	21190
21028	21196
21028	21202
21028	21208
21028	21214
21028	21220
21028	21226
21028	21232
21028	21238
21028	21244
21028	21250
21028	21256
21028	21262
21028	21268
21028	21274
21028	21280
21028	21286
21028	21292
21028	21298
21028	21304
21028	21310
21028	21316
21028	21322
21028	21328
21028	21334
21028	21340
21028	21346
21028	21352
21028	21358
21028	21364
21028	21370
21028	21376
21028	21382
21028	21388
21028	21394
21028	21400
21028	21406
21028	21412
21028	21418
21028	21424
21028	21430
21028	21436
21028	21442
21028	21448
21028	21454
21028	21460
21028	21466
21028	21472
21028	21478
21028	21484
21028	21490
21028	21496
21028	21502
21028	21508
21028	21514
21028	21520
21028	21526
21028	21532
21028	21538
21028	21544
21028	21550
21028	21556
21028	21562
21028	21568
21028	21574
21028	21580
21028	21586
21028	21592
21028	21598
21028	21604
21028	21610
21028	21616
21028	21622
21028	21628
21028	21634
21028	21640
21028	21646
21028	21652
21028	21658
21028	21664
21028	21670
21028	21676
21028	21682
21028	21688
21028	21694
21028	21700
21028	21706
21028	21712
21028	21718
21028	21724
21028	21730
21028	21736
21028	21742
21028	21748
21028	21754
21028	21760
21028	21766
21028	21772
21028	21778
21028	21784
21028	21790
21028	21796
21028	21802
21028	21808
21028	21814
21028	21820
21028	21826
21028	21832
21028	21838
21028	21844
21028	21850
21028	21856
21028	21862
21028	21868
21028	21874
21028	21880
21028	21886
21028	21892
21028	21898
21028	21904
21028	21910
21028	21916
21028	21922
21028	21928
21028	21934
21028	21940
21028	21946
21028	21952
21028	21958
21028	21964
21028	21970
21028	21976
21028	21982
21028	21988
21028	21994
21028	21999

Intercambio	Gates
21030	21018
21031	21026
21031	21035
21031	21047
21031	21056
21031	21068
21031	21080
21031	21092
21031	21104
21031	21116
21031	21128
21031	21140
21031	21152
21031	21164
21031	21176
21031	21188
21031	21200
21031	21212
21031	21224
21031	21236
21031	21248
21031	21260
21031	21272
21031	21284
21031	21296
21031	21308
21031	21320
21031	21332
21031	21344
21031	21356
21031	21368
21031	21380
21031	21392
21031	21404
21031	21416
21031	21428
21031	21440
21031	21452
21031	21464
21031	21476
21031	21488
21031	21500
21031	21512
21031	21524
21031	21536
21031	21548
21031	21560
21031	21572
21031	21584
21031	21596
21031	21608
21031	21620
21031	21632
21031	21

## Tablas de Equivalencias

Intercambio	Gates
0001	0001
0002	0002
0003	0003
0004	0004
0005	0005
0006	0006
0007	0007
0008	0008
0009	0009
0010	0010
0011	0011
0012	0012
0013	0013
0014	0014
0015	0015
0016	0016
0017	0017
0018	0018
0019	0019
0020	0020
0021	0021
0022	0022
0023	0023
0024	0024
0025	0025
0026	0026
0027	0027
0028	0028
0029	0029
0030	0030
0031	0031
0032	0032
0033	0033
0034	0034
0035	0035
0036	0036
0037	0037
0038	0038
0039	0039
0040	0040
0041	0041
0042	0042
0043	0043
0044	0044
0045	0045
0046	0046
0047	0047
0048	0048
0049	0049
0050	0050
0051	0051
0052	0052
0053	0053
0054	0054
0055	0055
0056	0056
0057	0057
0058	0058
0059	0059
0060	0060
0061	0061
0062	0062
0063	0063
0064	0064
0065	0065
0066	0066
0067	0067
0068	0068
0069	0069
0070	0070
0071	0071
0072	0072
0073	0073
0074	0074
0075	0075
0076	0076
0077	0077
0078	0078
0079	0079
0080	0080
0081	0081
0082	0082
0083	0083
0084	0084
0085	0085
0086	0086
0087	0087
0088	0088
0089	0089
0090	0090
0091	0091
0092	0092
0093	0093
0094	0094
0095	0095
0096	0096
0097	0097
0098	0098
0099	0099

Intercambio	Gates
0001	0014
0002	0001
0003	0018
0004	0008
0005	0012
0006	0006
0007	0017
0008	0011
0009	0013
0010	0009
0011	0016
0012	0012
0013	0004
0014	0003
0015	0015
0016	0024
0017	0012
0018	0002
0019	0017
0020	0013
0021	0001
0022	0010
0023	0002
0024	0018
0025	0001
0026	0012
0027	0008
0028	0016
0029	0006
0030	0011
0031	0013
0032	0009
0033	0015
0034	0004
0035	0003
0036	0017
0037	0012
0038	0002
0039	0016
0040	0001
0041	0010
0042	0002
0043	0018
0044	0001
0045	0012
0046	0008
0047	0016
0048	0006
0049	0011
0050	0013
0051	0009
0052	0015
0053	0004
0054	0003
0055	0017
0056	0012
0057	0002
0058	0016
0059	0001
0060	0010
0061	0002
0062	0018
0063	0001
0064	0012
0065	0008
0066	0016
0067	0006
0068	0011
0069	0013
0070	0009
0071	0015
0072	0004
0073	0003
0074	0017
0075	0012
0076	0002
0077	0016
0078	0001
0079	0010
0080	0002
0081	0018
0082	0001
0083	0012
0084	0008
0085	0016
0086	0006
0087	0011
0088	0013
0089	0009
0090	0015
0091	0004
0092	0003
0093	0017
0094	0012
0095	0002
0096	0016
0097	0001
0098	0010
0099	0002

Intercambio	Gates
0001	0018
0002	0007
0003	0008
0004	0012
0005	0003
0006	0016
0007	0012
0008	0018
0009	0006
0010	0013
0011	0009
0012	0015
0013	0004
0014	0003
0015	0017
0016	0012
0017	0002
0018	0016
0019	0001
0020	0010
0021	0002
0022	0018
0023	0001
0024	0012
0025	0008
0026	0016
0027	0006
0028	0011
0029	0013
0030	0009
0031	0015
0032	0004
0033	0003
0034	0017
0035	0012
0036	0002
0037	0016
0038	0001
0039	0010
0040	0002
0041	0018
0042	0001
0043	0012
0044	0008
0045	0016
0046	0006
0047	0011
0048	0013
0049	0009
0050	0015
0051	0004
0052	0003
0053	0017
0054	0012
0055	0002
0056	0016
0057	0001
0058	0010
0059	0002
0060	0018
0061	0001
0062	0012
0063	0008
0064	0016
0065	0006
0066	0011
0067	0013
0068	0009
0069	0015
0070	0004
0071	0003
0072	0017
0073	0012
0074	0002
0075	0016
0076	0001
0077	0010
0078	0002
0079	0018
0080	0001
0081	0012
0082	0008
0083	0016
0084	0006
0085	0011
0086	0013
0087	0009
0088	0015
0089	0004
0090	0003
0091	0017
0092	0012
0093	0002
0094	0016
0095	0001
0096	0010
0097	0002

Intercambio	Gates
0001	0021
0002	0008
0003	0018
0004	0006
0005	0012
0006	0003
0007	0017
0008	0013
0009	0009
0010	0015
0011	0004
0012	0003
0013	0017
0014	0012
0015	0002
0016	0016
0017	0001
0018	0010
0019	0002
0020	0018
0021	0001
0022	0012
0023	0008
0024	0016
0025	0006
0026	0011
0027	0013
0028	0009
0029	0015
0030	0004
0031	0003
0032	0017
0033	0012
0034	0002
0035	0016
0036	0001
0037	0010
0038	0002
0039	0018
0040	0001
0041	0012
0042	0008
0043	0016
0044	0006
0045	0011
0046	0013
0047	0009
0048	0015
0049	0004
0050	0003
0051	0017
0052	0012
0053	0002
0054	0016
0055	0001
0056	0010
0057	0002
0058	0018
0059	0001
0060	0012
0061	0008
0062	0016
0063	0006
0064	0011
0065	0013
0066	0009
0067	0015
0068	0004
0069	0003
0070	0017
0071	0012
0072	0002
0073	0016
0074	0001
0075	0010
0076	0002
0077	0018
0078	0001
0079	0012
0080	0008
0081	0016
0082	0006
0083	0011
0084	0013
0085	0009
0086	0015
0087	0004
0088	0003
0089	0017
0090	0012
0091	0002
0092	0016
0093	0001
0094	0010
0095	0002

Intercambio	Gates
0001	0001
0002	0017
0003	0008
0004	0012
0005	0006
0006	0011
0007	0017
0008	0003
0009	0013
0010	0009
0011	0015
0012	0004
0013	0003
0014	0017
0015	0012
0016	0002
0017	0016
0018	0001
0019	0010
0020	0002
0021	0018
0022	0001
0023	0012
0024	0008
0025	0016
0026	0006
0027	0011
0028	0013
0029	0009
0030	0015
0031	0004
0032	0003
0033	0017
0034	0012
0035	0002
0036	0016
0037	0001
0038	0010
0039	0002
0040	0018
0041	0001
0042	0012
0043	0008
0044	0016
0045	0006
0046	0011
0047	0013
0048	0009
0049	0015
0050	0004
0051	0003
0052	0017
0053	0012
0054	0002
0055	0016
0056	0001
0057	0010
0058	0002
0059	0018
0060	0001
0061	0012
0062	0008
0063	0016
0064	0006
0065	0011
0066	0013
0067	0009
0068	0015
0069	0004
0070	0003
0071	0017
0072	0012
0073	0002
0074	0016
0075	0001
0076	0010
0077	0002
0078	0018
0079	0001
0080	0012
0081	0008
0082	0016
0083	0006
0084	0011
0085	0013
0086	0009
0087	0015
0088	0004
0089	0003
0090	0017
0091	0012
0092	0002
0093	0016
0094	0001
0095	0010
0096	0002

## Tablas de Equivalencias

Intercambio	Gates	Intercambio	Gates	Intercambio	Gates	Intercambio	Gates	Intercambio	Gates
0001	0000	0040	0038	4001	0008	8001	0007	0000	0008
0001	0008	0040	0008	4001	0008	8008	0008	0000	0008
0001	0040	0040	0038	4002	0011	8008	0008	0000	0000
0001	0007	0040	0038	4002	0011	8008	0008	0000	0000
0001	0006	0040	0008	4002	0017	8008	0008	0000	0011
0001	0012	0040	0038	4002	0017	8008	0008	0000	0011
0007	0005	0047	0008	4004	0038	8008	0008	0000	0000
0007	0004	0048	0038	4004	0038	8008	0008	0000	0000
0001	0007	0040	0011	4005	0043	8001	0011	0000	0000
0040	0008	0040	0038	4005	0043	8008	0008	0000	0000
0040	0014	0048	0008	4006	0038	8008	0008	0000	0000
0040	0007	0047	0008	4006	0038	8008	0008	0000	0000
0040	0006	0048	0047	4007	0038	8008	0008	0000	0000
0040	0016	0000	0000	4007	0038	8004	0008	0000	0000
0040	0017	0000	0000	4008	0038	8004	0008	0000	0000
0040	0011	0000	0000	4008	0038	8008	0047	0000	0008
0040	0004	0000	0000	4009	0038	8008	0008	0000	0008
0040	0008	0000	0008	4009	0038	8008	0008	0000	0008
0041	0008	0000	0008	4009	0038	8008	0008	0000	0008
0041	0012	0004	0008	4009	0038	8008	0008	0000	0008
0041	0010	0004	0008	4009	0038	8008	0008	0000	0008
0041	0011	0004	0008	4009	0038	8008	0008	0000	0008
0041	0012	0004	0008	4009	0038	8008	0008	0000	0008
0041	0013	0004	0008	4009	0038	8008	0008	0000	0008
0041	0014	0004	0008	4009	0038	8008	0008	0000	0008
0041	0015	0004	0008	4009	0038	8008	0008	0000	0008
0041	0016	0004	0008	4009	0038	8008	0008	0000	0008
0041	0017	0004	0008	4009	0038	8008	0008	0000	0008
0041	0018	0004	0008	4009	0038	8008	0008	0000	0008
0041	0019	0004	0008	4009	0038	8008	0008	0000	0008
0041	0020	0004	0008	4009	0038	8008	0008	0000	0008
0041	0021	0004	0008	4009	0038	8008	0008	0000	0008
0041	0022	0004	0008	4009	0038	8008	0008	0000	0008
0041	0023	0004	0008	4009	0038	8008	0008	0000	0008
0041	0024	0004	0008	4009	0038	8008	0008	0000	0008
0041	0025	0004	0008	4009	0038	8008	0008	0000	0008
0041	0026	0004	0008	4009	0038	8008	0008	0000	0008
0041	0027	0004	0008	4009	0038	8008	0008	0000	0008
0041	0028	0004	0008	4009	0038	8008	0008	0000	0008
0041	0029	0004	0008	4009	0038	8008	0008	0000	0008
0041	0030	0004	0008	4009	0038	8008	0008	0000	0008
0041	0031	0004	0008	4009	0038	8008	0008	0000	0008
0041	0032	0004	0008	4009	0038	8008	0008	0000	0008
0041	0033	0004	0008	4009	0038	8008	0008	0000	0008
0041	0034	0004	0008	4009	0038	8008	0008	0000	0008
0041	0035	0004	0008	4009	0038	8008	0008	0000	0008
0041	0036	0004	0008	4009	0038	8008	0008	0000	0008
0041	0037	0004	0008	4009	0038	8008	0008	0000	0008
0041	0038	0004	0008	4009	0038	8008	0008	0000	0008
0041	0039	0004	0008	4009	0038	8008	0008	0000	0008
0041	0040	0004	0008	4009	0038	8008	0008	0000	0008
0041	0041	0004	0008	4009	0038	8008	0008	0000	0008

## Tablas de Equivalencias

Intercambio	Gate	Intercambio	Gate	Intercambio	Gate	Intercambio	Gate	Intercambio	Gate
4011	3000	4024	3008	4037	3016	4050	3024	4063	3032
4012	3001	4025	3009	4038	3017	4051	3025	4064	3033
4013	3002	4026	3010	4039	3018	4052	3026	4065	3034
4014	3003	4027	3011	4040	3019	4053	3027	4066	3035
4015	3004	4028	3012	4041	3020	4054	3028	4067	3036
4016	3005	4029	3013	4042	3021	4055	3029	4068	3037
4017	3006	4030	3014	4043	3022	4056	3030	4069	3038
4018	3007	4031	3015	4044	3023	4057	3031	4070	3039
4019	3008	4032	3016	4045	3024	4058	3032	4071	3040
4020	3009	4033	3017	4046	3025	4059	3033	4072	3041
4021	3010	4034	3018	4047	3026	4060	3034	4073	3042
4022	3011	4035	3019	4048	3027	4061	3035	4074	3043
4023	3012	4036	3020	4049	3028	4062	3036	4075	3044
4024	3013	4037	3021	4050	3029	4063	3037	4076	3045
4025	3014	4038	3022	4051	3030	4064	3038	4077	3046
4026	3015	4039	3023	4052	3031	4065	3039	4078	3047
4027	3016	4040	3024	4053	3032	4066	3040	4079	3048
4028	3017	4041	3025	4054	3033	4067	3041	4080	3049
4029	3018	4042	3026	4055	3034	4068	3042	4081	3050
4030	3019	4043	3027	4056	3035	4069	3043	4082	3051
4031	3020	4044	3028	4057	3036	4070	3044	4083	3052
4032	3021	4045	3029	4058	3037	4071	3045	4084	3053
4033	3022	4046	3030	4059	3038	4072	3046	4085	3054
4034	3023	4047	3031	4060	3039	4073	3047	4086	3055
4035	3024	4048	3032	4061	3040	4074	3048	4087	3056
4036	3025	4049	3033	4062	3041	4075	3049	4088	3057
4037	3026	4050	3034	4063	3042	4076	3050	4089	3058
4038	3027	4051	3035	4064	3043	4077	3051	4090	3059
4039	3028	4052	3036	4065	3044	4078	3052	4091	3060
4040	3029	4053	3037	4066	3045	4079	3053	4092	3061
4041	3030	4054	3038	4067	3046	4080	3054	4093	3062
4042	3031	4055	3039	4068	3047	4081	3055	4094	3063
4043	3032	4056	3040	4069	3048	4082	3056	4095	3064
4044	3033	4057	3041	4070	3049	4083	3057	4096	3065
4045	3034	4058	3042	4071	3050	4084	3058	4097	3066
4046	3035	4059	3043	4072	3051	4085	3059	4098	3067
4047	3036	4060	3044	4073	3052	4086	3060	4099	3068
4048	3037	4061	3045	4074	3053	4087	3061	4100	3069
4049	3038	4062	3046	4075	3054	4088	3062	4101	3070
4050	3039	4063	3047	4076	3055	4089	3063	4102	3071
4051	3040	4064	3048	4077	3056	4090	3064	4103	3072
4052	3041	4065	3049	4078	3057	4091	3065	4104	3073
4053	3042	4066	3050	4079	3058	4092	3066	4105	3074
4054	3043	4067	3051	4080	3059	4093	3067	4106	3075
4055	3044	4068	3052	4081	3060	4094	3068	4107	3076
4056	3045	4069	3053	4082	3061	4095	3069	4108	3077
4057	3046	4070	3054	4083	3062	4096	3070	4109	3078
4058	3047	4071	3055	4084	3063	4097	3071	4110	3079
4059	3048	4072	3056	4085	3064	4098	3072	4111	3080
4060	3049	4073	3057	4086	3065	4099	3073	4112	3081
4061	3050	4074	3058	4087	3066	4100	3074	4113	3082
4062	3051	4075	3059	4088	3067	4101	3075	4114	3083
4063	3052	4076	3060	4089	3068	4102	3076	4115	3084
4064	3053	4077	3061	4090	3069	4103	3077	4116	3085
4065	3054	4078	3062	4091	3070	4104	3078	4117	3086
4066	3055	4079	3063	4092	3071	4105	3079	4118	3087
4067	3056	4080	3064	4093	3072	4106	3080	4119	3088
4068	3057	4081	3065	4094	3073	4107	3081	4120	3089
4069	3058	4082	3066	4095	3074	4108	3082	4121	3090
4070	3059	4083	3067	4096	3075	4109	3083	4122	3091
4071	3060	4084	3068	4097	3076	4110	3084	4123	3092
4072	3061	4085	3069	4098	3077	4111	3085	4124	3093
4073	3062	4086	3070	4099	3078	4112	3086	4125	3094
4074	3063	4087	3071	4100	3079	4113	3087	4126	3095
4075	3064	4088	3072	4101	3080	4114	3088	4127	3096
4076	3065	4089	3073	4102	3081	4115	3089	4128	3097
4077	3066	4090	3074	4103	3082	4116	3090	4129	3098
4078	3067	4091	3075	4104	3083	4117	3091	4130	3099
4079	3068	4092	3076	4105	3084	4118	3092	4131	3100
4080	3069	4093	3077	4106	3085	4119	3093	4132	3101
4081	3070	4094	3078	4107	3086	4120	3094	4133	3102
4082	3071	4095	3079	4108	3087	4121	3095	4134	3103
4083	3072	4096	3080	4109	3088	4122	3096	4135	3104
4084	3073	4097	3081	4110	3089	4123	3097	4136	3105
4085	3074	4098	3082	4111	3090	4124	3098	4137	3106
4086	3075	4099	3083	4112	3091	4125	3099	4138	3107
4087	3076	4100	3084	4113	3092	4126	3100	4139	3108
4088	3077	4101	3085	4114	3093	4127	3101	4140	3109
4089	3078	4102	3086	4115	3094	4128	3102	4141	3110
4090	3079	4103	3087	4116	3095	4129	3103	4142	3111
4091	3080	4104	3088	4117	3096	4130	3104	4143	3112
4092	3081	4105	3089	4118	3097	4131	3105	4144	3113
4093	3082	4106	3090	4119	3098	4132	3106	4145	3114
4094	3083	4107	3091	4120	3099	4133	3107	4146	3115
4095	3084	4108	3092	4121	3100	4134	3108	4147	3116
4096	3085	4109	3093	4122	3101	4135	3109	4148	3117
4097	3086	4110	3094	4123	3102	4136	3110	4149	3118
4098	3087	4111	3095	4124	3103	4137	3111	4150	3119
4099	3088	4112	3096	4125	3104	4138	3112	4151	3120
4100	3089	4113	3097	4126	3105	4139	3113	4152	3121
4101	3090	4114	3098	4127	3106	4140	3114	4153	3122
4102	3091	4115	3099	4128	3107	4141	3115	4154	3123
4103	3092	4116	3100	4129	3108	4142	3116	4155	3124
4104	3093	4117	3101	4130	3109	4143	3117	4156	3125
4105	3094	4118	3102	4131	3110	4144	3118	4157	3126
4106	3095	4119	3103	4132	3111	4145	3119	4158	3127
4107	3096	4120	3104	4133	3112	4146	3120	4159	3128
4108	3097	4121	3105	4134	3113	4147	3121	4160	3129
4109	3098	4122	3106	4135	3114	4148	3122	4161	3130
4110	3099	4123	3107	4136	3115	4149	3123	4162	3131
4111	3100	4124	3108	4137	3116	4150	3124	4163	3132
4112	3101	4125	3109	4138	3117	4151	3125	4164	3133
4113	3102	4126	3110	4139	3118	4152	3126	4165	3134
4114	3103	4127	3111	4140	3119	4153	3127	4166	3135
4115	3104	4128	3112	4141	3120	4154	3128	4167	3136
4116	3105	4129	3113	4142	3121	4155	3129	4168	3137
4117	3106	4130	3114	4143	3122	4156	3130	4169	3138
4118	3107	4131	3115	4144	3123	4157	3131	4170	3139
4119	3108	4132	3116	4145	3124	4158	3132	4171	3140
4120	3109	4133	3117	4146	3125	4159	3133	4172	3141
4121	3110	4134	3118	4147	3126	4160	3134	4173	3142
4122	3111	4135	3119	4148	3127	4161	3135	4174	3143
4123	3112	4136	3120	4149	3128	4162	3136	4175	3144
4124	3113	4137	3121	4150	3129	4163	3137	4176	3145
4125	3114	4138	3122	4151	3130	4164	3138	4177	3146
4126	3115	4139	3123	4152	3131	4165	3139	4178	3147
4127	3116	4140	3124	4153	3132	4166	3140	4179	3148
4128	3117	4141	3125	4154	3133	4167	3141	4180	3149
4129	3118	4142	3126	4155	3134	4168	3142	4181	3150
4130	3119	4143	3127	4156	3135	4169	3143	4182	3151
4131	3120	4144	3128	4157	3136	4170	3144	4183	3152
4132	3121	4145	3129	4158	3137	4171	3145	4184	3153
4133	3122	4146	3130	4159	3138	4172	3146	4185	3154
4134	3123	4147	3131	4160	3139	4173	3147	4186	3155
4135	3124	4148	3132	4161	3140	4174	3148	4187	3156
4136	3125	4149	3133	4162	3141	4175	3149	4188	3157
4137	3126	4150	3134	4163	3142	4176	3150	4189	3158
4138	3127	4151	3135	4164	3143	4177	3151	4190	3159
4139	3128	4152	3136	4165					

